

PART NO.	ENG. NO.	DIM. "A"
18-09-2803	2282-(P90 I)	
18-09-2804	2282-(P90 I/L)	.161±.004/(4.09±0.10)
18-09-2807	2282-(P90 I/L I)	.215±.005/(5.46±0.13)
	-	
	-	
	-	

**LEGEND**

2282-(\*\*\*\*)\*\*

P=PREPLATE  
BLANK=POSTPLATE

FINISH CODE

CARRIER CUTOFF WIDTH  
(ONLY APPLIES TO FORM "L")  
BLANK=.161±.004  
I=.215±.005

FORM  
BLANK=CHAIN  
L=LOOSE

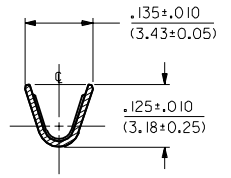
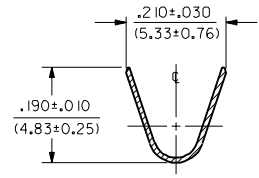
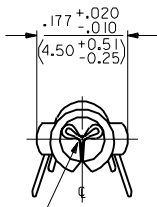

SECTION A-A SECTION B-B

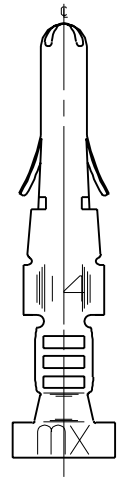
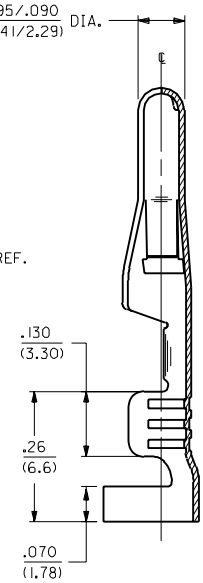
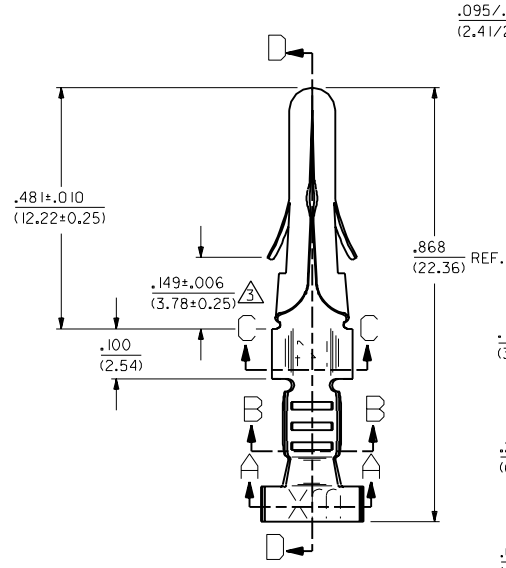

SECTION D-D

- NOTES:
1. TERMINAL WILL ACCEPT 14 - 18 AWG WIRE.
  2. TERMINAL FOR CHRYSLER CORP. USE ONLY.
  - WHERE DENOTED, THIS DIMENSION TO BE .140-.145/(3.56-3.68) WHEN LOCK TABS ARE COMPRESSED TO .136-.142/(3.92-4.10).
  - USE CRIMP DIE CD2052-C TO PRODUCE .161 CUT OFF AND CD2052-E TO PRODUCE .215 CUT OFF.

FINISH CODES:  
901 HOT TIN DIP .000020/(0.0005) MIN.

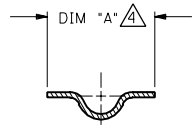

SECTION C-C

MATERIAL NOTES:  
1. RED BRASS, ALLOY #C23000;  
.010/(0.25) THICK, EXTRA SPRING TEMPER.

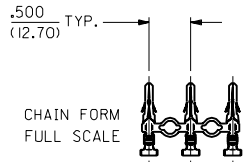

CHAIN FORM  
FULL SCALE

DIMENSIONS SHOWN METRIC (INCH UNLESS OTHERWISE SPECIFIED)		TOLERANCES ANGULAR ± 1/2°		TITLE	
3 PLACE ± .010	METRIC ---	▽ = 0 ▼ = 0		REVISE ONLY ON CAD SYSTEM	
2 PLACE ± .014 ± 0.25	---	MFG. SH. REV. LTR. REVISIONS		CRIMP TERMINAL, MALE, .093/(2.36) DIA. FOR 14 THRU 18 AWG WIRE	
1 PLACE --- ± 0.36	---	DRAWING NO. SD-2282-*		SHEET NO. 1 of 1 DATE 10/13/92	
DRAFT WHERE APPLICABLE MUST REMAIN WITHIN DIMENSIONS		PART NO. 2282		MOLEX INCORPORATED	
DRAWN BY: CWF		CHKD. BY: RW		FILE NAME: SD2282X1	
APP'D: CWF		SCALE: 6:1		DIV. CP	

F1	REV'D. AND REDRAW ECR 11/10/97 CKC 10/13/92	RW
----	---	----