

## Data sheet / Datenblatt 521412000

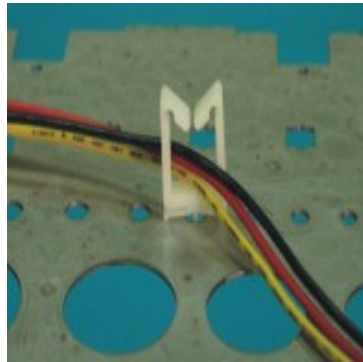
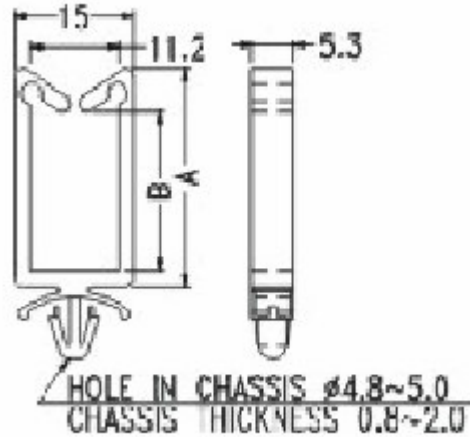

Artikelnr. / Article no. 521412000

Material: PA 6.6 UL 94-V2

Screw Mount Clamp

Colour: natural

A = 12.0

B = 5.0

Geprüft / Drawn  
Mark Wirth  
2007-03-26

Würth Elektronik eiSos GmbH & Co KG  
D – 74638 Waldenburg  
Max-Eyth-Straße 1  
Tel.: 0049 7942-945-0 / Fax: 0049 7942-945-400  
[www.we-online.de](http://www.we-online.de)