

Tous droits strictement reserves. Reproduction ou communication a des tiers interdite sous quelque forme que ce soit sans autorisation écrite du propriétaire. Propriete de c FCI. Droits de reproduction FCI.

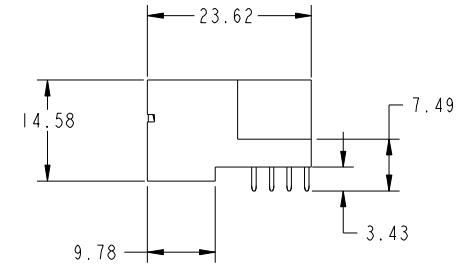

All rights strictly reserved. Reproduction or issue to third parties in any form whatever is not permitted without written authority from the proprietor. Property of FCI. Copyright FCI.

PRODUCT NO.	ROWS	POWER								SIGNAL								
		E1	P1	P2	P3	P4	P5	P6	P7	P8	1	2	3	4	5	6	E2	
51732-011... NOTE: 3	D C B A		PA	PA	PA	PA	PA	PA	PA	PA	UUUU	UUUU	UUUU	UUUU	UUUU	UUUU	UUUU	UUUU
											TTT	TTT	TTT	TTT	TTT	TTT	TTT	
											SSS	SSS	SSS	SSS	SSS	SSS	SSS	
											RRR	RRR	RRR	RRR	RRR	RRR	RRR	

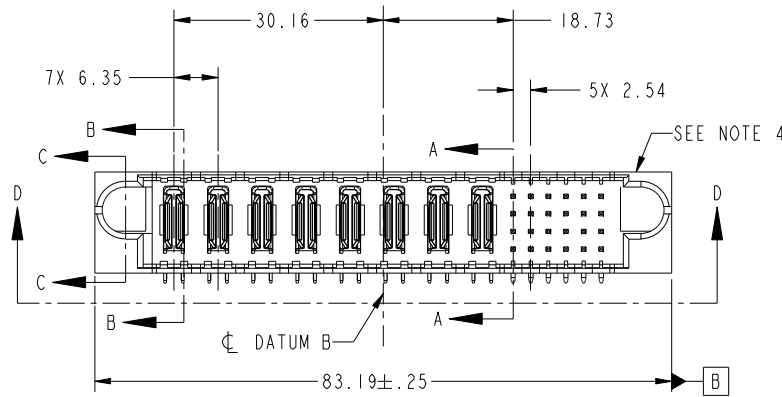

ITEM NO.	DIM "M" MATING LENGTH	CONTACT TYPE
E	[5.59]	SIGNAL
F	[5.59]	SIGNAL
G	[5.59]	SIGNAL
H	[5.59]	SIGNAL
R	[6.86]	SIGNAL
S	[6.86]	SIGNAL
T	[6.86]	SIGNAL
U	[6.86]	SIGNAL
PA	[N/A]	POWER

mat'l code				SEE NOTE		tolerances unless otherwise specified		CUSTOMER		FCI	
ltr	ecn no.	dr	date	linear	0.X ± 0.5	projection		COPY		www.fciconnect.com	
A	V20382	DAI	02-25-02	0.XX ± 0.25	0° ± 2°		MIM		title		
B	V21141	DAI	06/28/02	0.XXX ± 0.10	scale		1:1		8P + 24S RIGHT ANGLE SOLDER HEADER		
C	DG05-0240	GuoJM	07/26/05	chr	D. INGRAM	02-25-02	product family		PwrBlade	code	
D	DG05-0554	GuoJM	12/19/05	appr	M.MOSTOLLER	06/28/02	size		A	213	
E	DG07-0498	JW	09/15/08		M.MOSTOLLER	02-25-02	dwg no		51732-011		
sheet index		revision sheet		E	E	E	E	scale		sheet	
				1	2	3	4	1 of 4			

cage code 22526

Pro/E

Tous droits strictement reserves. Reproduction ou communication a des tiers interdite sous quelque forme que ce soit sans autorisation écrite du propriétaire. Propriete de c FCI. Droits de reproduction FCI.



All rights strictly reserved. Reproduction or issue to third parties in any form whatever is not permitted without written authority from the proprietor. Property of FCI. Copyright FCI.

PRODUCT NUMBER
51732-011--
NOTE: 3

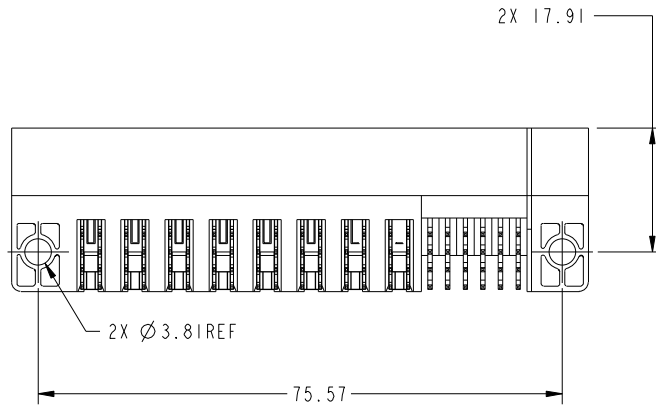

VIEW D-D

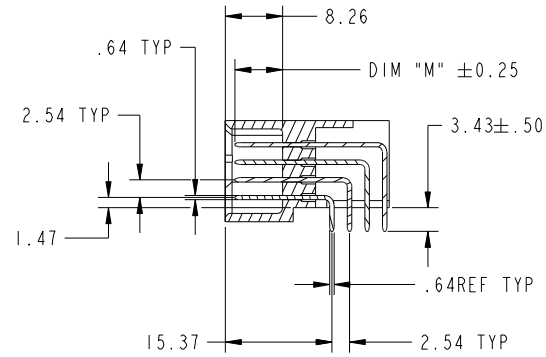

SECTION A-A

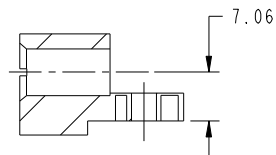

SECTION C-C

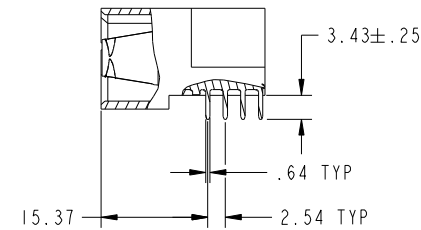

SECTION B-B

mat'l code		SEE NOTE		tolerances unless otherwise specified		CUSTOMER		www.fciconnect.com	
ltr	ecr no.	dr	date	linear	0.X ±0.5	COPY		title	
E					0.XX ±0.25	projection		8P + 24S	
				angles	0.XXX ±0.10			RIGHT ANGLE SOLDER HEADER	
				dr	0° ±2°			product family PwrBlade code	
				enrg	D. INGRAM 02-25-02	scale		size	
				chr	M.MOSTOLLER 06/28/02	1:1		dwg no	
				appd	M.MOSTOLLER 02-25-02			51732-011	
					M.MOSTOLLER 02-25-02			sheet	
sheet index	revision sheet							213	
								2	

cage code 22526

Pro/E

Tous droits strictement reserves. Reproduction ou communication a des tiers interdite sous quelque forme que ce soit sans autorisation écrite du propriétaire. Propriete de c FCI. Droits de reproduction FCI.



All rights strictly reserved. Reproduction or issue to third parties in any form whatever is not permitted without written authority from the proprietor. Property of FCI. Copyright FCI.

PRODUCT NUMBER
51732-011--
NOTE: 3

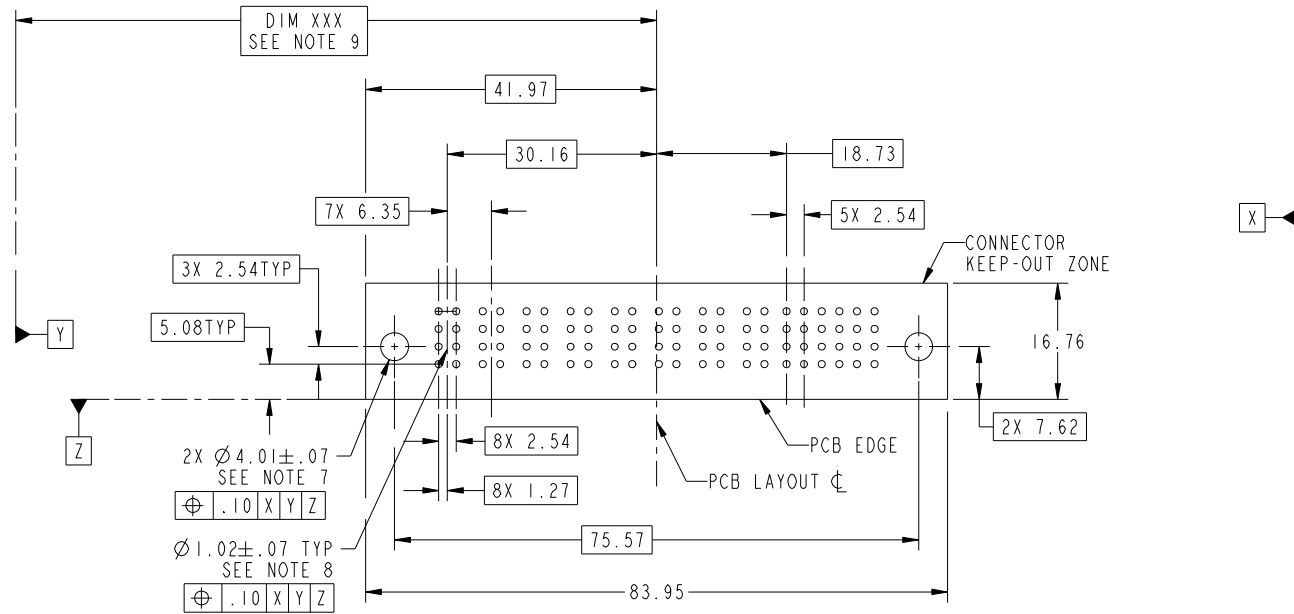

RECOMMENDED PCB LAYOUT

mat'l code		SEE NOTE		tolerances unless otherwise specified		CUSTOMER		www.fciconnect.com	
ltr	ecn no.	dr	date	linear	0.X ± 0.5	COPY		title	
E					0.XX ± 0.25	projection		8P + 24S	
				angles	0.XXX ± 0.10			RIGHT ANGLE SOLDER HEADER	
				dr	0° ± 2°			product family PwrBlade code 213	
				enrg	D. INGRAM 02-25-02	scale		size dwg no 213	
				chr	M. MOSTOLLER 06/28/02	1:1		sheet 3	
				appd	M. MOSTOLLER 02-25-02	A		51732-011	
sheet index	revision sheet								

cage code 22526

Pro/E

Tous droits strictement reserves. Reproduction ou communication a des tiers interdite sous quelque forme que ce soit sans autorisation écrite du propriétaire. Propriete de c FCI. Droits de reproduction FCI.



All rights strictly reserved. Reproduction or issue to third parties in any form whatever is not permitted without written authority from the proprietor. Property of FCI. Copyright FCI.

PRODUCT NUMBER
51732-011-- NOTE: 3

NOTES:

1. DIMENSIONS AND TOLERANCES ARE IN ACCORDANCE WITH ASME Y14.5M, 1994 UNLESS OTHERWISE SPECIFIED.

CONNECTORS NOTES:

2. HOUSING MATERIAL: UL 94 V-0 GLASS FILLED HIGH TEMP THERMO PLASTIC
POWER CONTACT MATERIAL: COPPER ALLOY
SIGNAL PIN MATERIAL: COPPER ALLOY

3. PLATING:
SEE ITEM 1 & 2 IN PRINT 10064183 FOR PLATING SPEC OF 51732-011; 51552-001LF PRESPECTIVELY

4. "MANUFACTURER" NAME, P/N, AND DATE CODE TO APPEAR ON THIS SURFACE.

5. PRODUCT SPECIFICATION GS-12-149.

PCB - NOTES:

6. ALL HOLE DIAMETERS ARE FINISHED HOLE SIZE.

7. HOLD DOWN THROUGH HOLES ARE UNPLATED.

8. $\varnothing 1.151 \pm 0.025$ DRILLED HOLES PLATED WITH 0.008 MIN SnPb OR Sn OVER 0.03 TO 0.08 Cu PLATING TO ACHIEVE $\varnothing 1.02 \pm .07$ HOLE.

9. "DIM XXX" TO BE DETERMINED BY THE CUSTOMER.

10. A SYMBOL WILL BE NEXT TO ANY DIMENSION, VIEW, OR NOTE WHICH HAS BEEN MODIFIED WITH THE CURRENT DRAWING REVISION.

mat'l code		SEE NOTE		tolerances unless otherwise specified		CUSTOMER		www.fciconnect.com	
ltr	ecr no.	dr	date	linear	0.X ± 0.5	COPY		title	
E					0.XX ± 0.25	projection		8P + 24S	
				angles	0.XXX ± 0.10			RIGHT ANGLE SOLDER HEADER	
				dr	0° + 2°	MIM		product family PwrBlade code	
				enrg	D. INGRAM 02-25-02			size 213	
				chr	M.MOSTOLLER 06/28/02	scale		dwg no 51732-011 sheet	
				appd	M.MOSTOLLER 02-25-02	1:1		4	
sheet index	revision sheet								

cage code 22526

Pro/E