

AMPHENOL PART NUMBER CONFIGURATION

U 9 5 - Z 1 0 5 - X X X 1 - X X 1

CAGE & CONNECTOR CONTACT PLATING

4 = 0.76 µm MIN. GOLD OVER 1.27-3.81 µm OF NICKEL ON MATING AREA
 0.381-1.52 µm OF MATTE TIN OVER 1.27-3.81 µm OF NICKEL ON PRESS FIT TAIL AREA.
 Ni PLATING FOR CAGE
 (RoHS COMPLIANT PER RoHS DIRECTIVE 2011/65/EU)

OPTIONAL DUST COVER

0 = WITHOUT DUST COVER
 D = WITH DUST COVER

VENT HOLES AND EMI COVER

0 = WITH LARGE VENT HOLES & WITH EMI COVER
 2 = WITH SMALL VENT HOLES & WITH EMI COVER
 4 = WITH RECTANGULAR VENT HOLES & WITH EMI COVER

EMI GASKET

1 = CHOMERICS 1273 CONDUCTIVE ELASTOMER
 2 = CHOMERICS S6305 CONDUCTIVE ELASTOMER

OPTIONAL LIGHT PIPES

6 = WITH LIGHT PIPE (TRIANGULAR OUTLET)
 LEFT ARROW POINTING BOTTOM PORT &
 RIGHT ARROW POINTING TOP PORT
 7 = WITHOUT LIGHT PIPE
 8 = WITH LIGHT PIPE (REVERSED DIRECTION)
 LEFT ARROW POINTING TOP PORT &
 RIGHT ARROW POINTING BOTTOM PORT

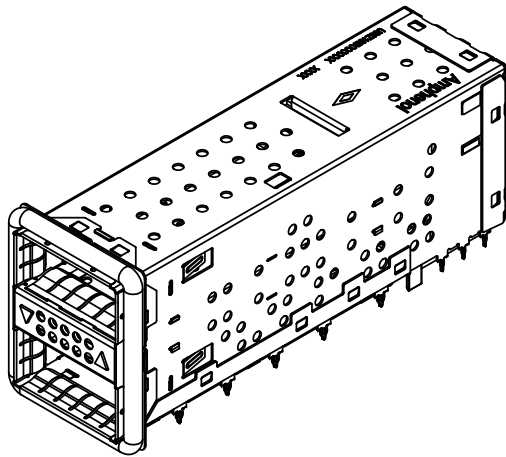

REVISIONS			
REV	DESCRIPTION, ECN, EAR NO.	DATE	APP'D
D	Title Box Heading Modified	NOV 05/13	ZLJ
E	Vent hole update for U95-Z105-XXX1-X41	OCT 23/14	JS



VENT HOLE FOR PART NUMBER U95-Z105-XX71-X01

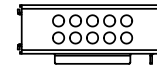

VENT HOLE FOR PART NUMBER U95-Z105-XX71-X21

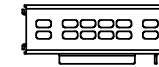

VENT HOLE FOR PART NUMBER U95-Z105-XX71-X41

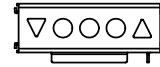

VENT HOLE FOR PART NUMBER U95-Z105-XX61-X01

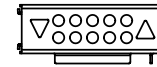

VENT HOLE FOR PART NUMBER U95-Z105-XX61-X21

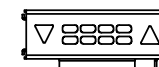

VENT HOLE FOR PART NUMBER U95-Z105-XX61-X41

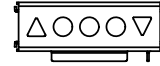

VENT HOLE FOR PART NUMBER U95-Z105-XX81-X01

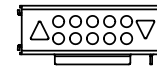

VENT HOLE FOR PART NUMBER U95-Z105-XX81-X21



VENT HOLE FOR PART NUMBER U95-Z105-XX81-X41

NOTES:

- MATERIAL
 CAGE-PRESS FIT: COPPER ALLOY, NICKEL PLATED
 CONNECTOR-PRESS FIT: PLASTIC HOUSING, FLAMMABILITY RATING UL94 V-0.
 CONTACTS: PHOSPHOR BRONZE
 PLATING OPTION: SEE AMPHENOL PART ON CONFIGURATION
 EMI GASKET: CONDUCTIVE ELASTOMER
 LIGHT PIPE: GE LEXAN, OPTICAL GRADE
 DUST COVER (IF ORDERED) SHIPPED LOOSE



UNLESS SPECIFIED OTHERWISE	DRAWN	Alvin C	APR 18/13
PRIMARY UNITS	MILLIMETERS	CHECKED	ZLJ
SECONDARY	MILLIMETERS	M.E. APP'D	APR 18/13
REFERENCE IN PARENTHESES		Q.A. APP'D	
GENERAL TOLERANCES		DWG APP'D	
1 DECIMAL PLACE	±0.25	ENG. REL. NO.	
2 DECIMAL PLACES	±0.15	REF.	
ANGULAR DEGREES	±0.5°	THIRD ANGLE PROJECTION	DO NOT SCALE DRAWING

Amphenol High Speed Interconnects A Division of Amphenol Corp. www.amphenol-highspeed.com			
UltraPort QSFP+ 2X1 STACKED COMBO WITH EMI GASKET 4X25G			
DWG. NO.	P-U95-Z105-XXX1-XX1		REV E
CODE ID NO.	03554	DWG SIZE: C	SCALE: 1:1 SHEET 1 OF 4

REVISIONS			
REV	DESCRIPTION, ECN, EAR NO.	DATE	APP'D
D	Title Box Heading Modified	NOV 05/13	ZLJ
E	Vent hole update for U95-Z105-XX71-X41	OCT 23/14	JS

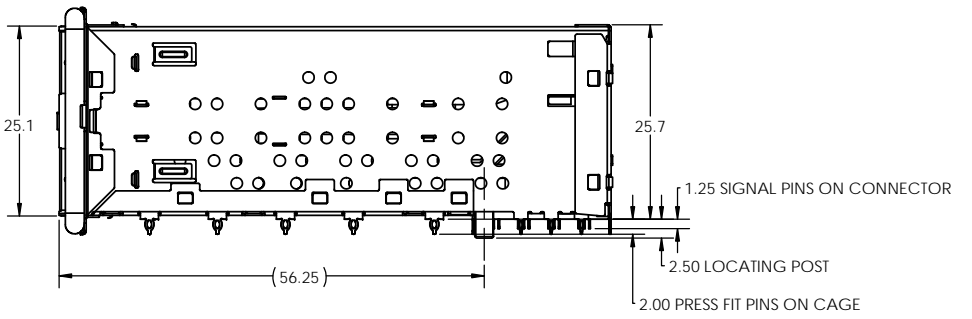
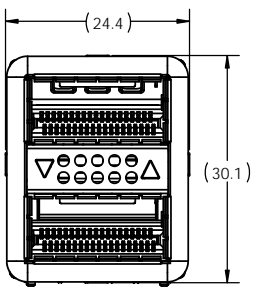
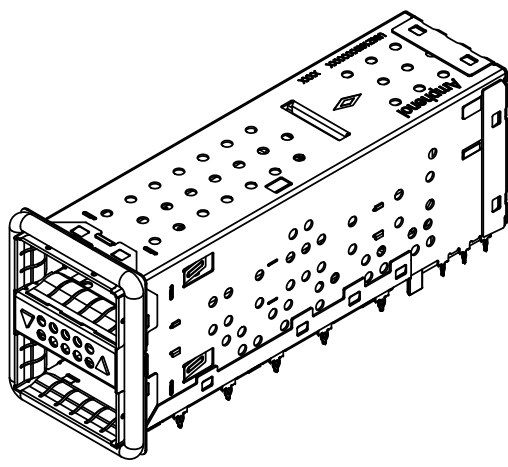
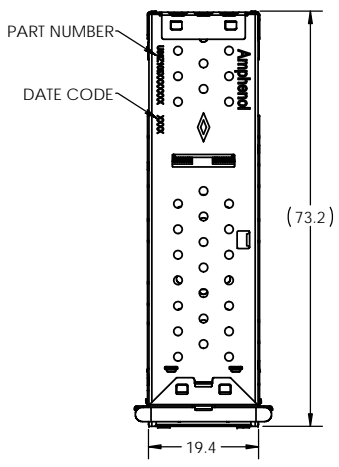

THIS DOCUMENT CONTAINS PROPRIETARY INFORMATION AND SUCH INFORMATION MAY NOT BE DISCLOSED TO OTHERS FOR ANY PURPOSE OR USED FOR MANUFACTURING PURPOSES WITHOUT WRITTEN PERMISSION FROM AMPHENOL CANADA CORP.

UNLESS SPECIFIED OTHERWISE	DRAWN	Alvin C	APR 18/13
PRIMARY UNITS	MILLIMETERS	CHECKED	ZLJ
SECONDARY	MILLIMETERS	M.E.	APP'D
REFERENCE IN PARENTHESES		Q.A.	APP'D
GENERAL TOLERANCES		DWG.	APP'D
1 DECIMAL PLACE	±0.25	ENG.	REL. NO.
2 DECIMAL PLACES	±0.15	REF.	
ANGULAR DEGREES	±0.5°	THIRD ANGLE PROJECTION	DO NOT SCALE DRAWING

Amphenol High Speed Interconnects
 A Division of Amphenol Corp. www.amphenol-highspeed.com

**UltraPort QSFP+ 2X1
 STACKED COMBO
 WITH EMI GASKET
 4X25G**

DWG. NO. **P-U95-Z105-XXX1-XX1** REV **E**

CODE ID NO. **03554** DWG SIZE: **C** SCALE: **1:1** SHEET **2** OF **4**

REVISIONS			
REV	DESCRIPTION, ECN, EAR NO.	DATE	APP'D
D	Title Box Heading Modified	NOV 05/13	ZLJ
E	Vent hole update for U95-Z105-XX71-X41	OCT 23/14	JS

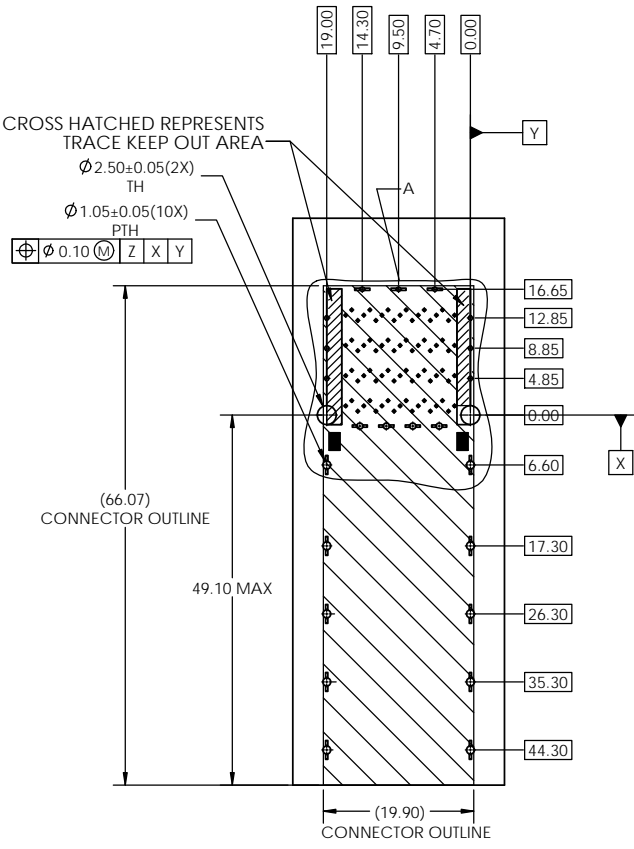

RECOMMENDED PCB BOARD LAYOUT
COMPONENT SIDE SHOWN

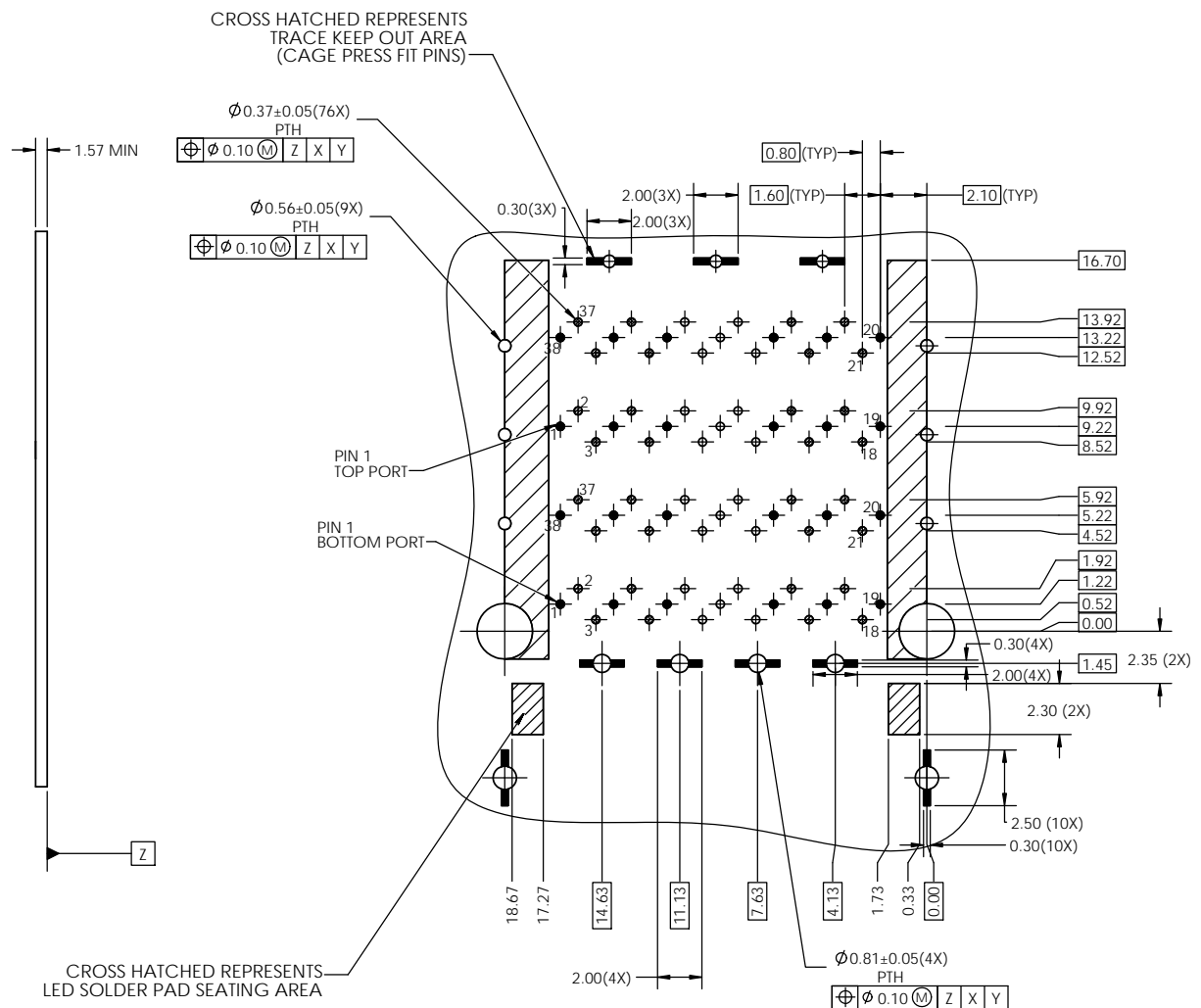

DETAIL A
SCALE 6:1

THIS DOCUMENT CONTAINS PROPRIETARY INFORMATION AND SUCH INFORMATION MAY NOT BE DISCLOSED TO OTHERS FOR ANY PURPOSE OR USED FOR MANUFACTURING PURPOSES WITHOUT WRITTEN PERMISSION FROM AMPHENOL CANADA CORP.

UNLESS SPECIFIED OTHERWISE	DRAWN	Alvin C	APR 18/13
PRIMARY UNITS	MILLIMETERS	CHECKED	ZLJ
SECONDARY	MILLIMETERS	M.E. APP'D	
REFERENCE IN PARENTHESES		Q.A. APP'D	
GENERAL TOLERANCES		DWG APP'D	
1 DECIMAL PLACE	±0.25	ENG. REL. NO.	
2 DECIMAL PLACES	±0.15	REF.	
ANGULAR DEGREES	±0.5°	THIRD ANGLE PROJECTION	
		DO NOT SCALE DRAWING	

Amphenol High Speed Interconnects
A Division of Amphenol Corp. www.amphenol-highspeed.com

**UltraPort QSFP+ 2X1
STACKED COMBO
WITH EMI GASKET
4X25G**

DWG. NO. **P-U95-Z105-XXX1-XX1** REV **E**

CODE ID. NO. **03554** DWG. SIZE: **C** SCALE: **2:1** SHEET **3** OF **4**

REVISIONS			
REV	DESCRIPTION, ECN, EAR NO.	DATE	APP'D
D	Title Box Heading Modified	NOV 05/13	ZLJ
E	Vent hole update for U95-Z105-XX71-X41	OCT 23/14	JS

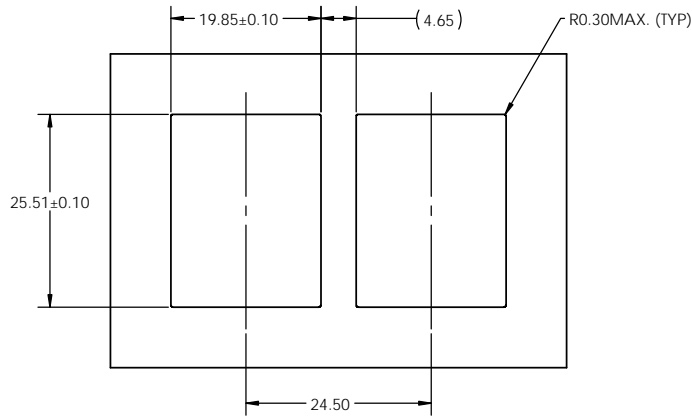
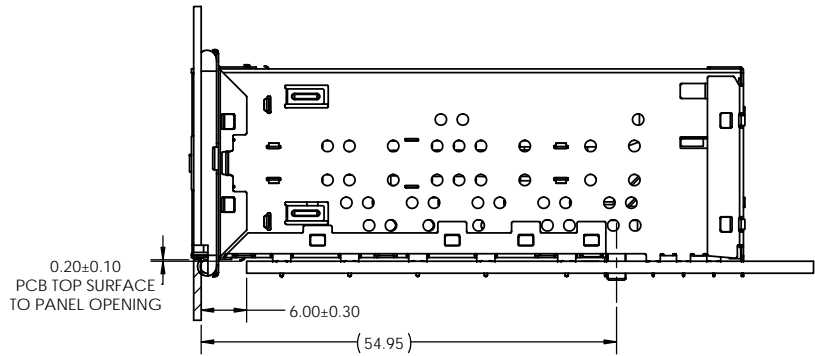

UNLESS SPECIFIED OTHERWISE	DRAWN	Alvin C	APR 18/13
PRIMARY UNITS	MILLIMETERS	CHECKED	ZLJ
SECONDARY	MILLIMETERS	M.E.	APP'D
REFERENCE IN PARENTHESES		Q.A.	APP'D
GENERAL TOLERANCES		DWG.	APP'D
1 DECIMAL PLACE	±0.25	ENG. REL. NO.	
2 DECIMAL PLACES	±0.15	REF.	
ANGULAR DEGREES	±0.5°	THIRD ANGLE PROJECTION	DO NOT SCALE DRAWING

Amphenol High Speed Interconnects			
A Division of Amphenol Corp. www.amphenol-highspeed.com			
UltraPort QSFP+ 2X1 STACKED COMBO WITH EMI GASKET 4X25G			
DWG. NO.	P-U95-Z105-XXX1-XX1		REV E
CODE ID NO.	03554	DWG SIZE: C	SCALE: 1:1 SHEET 4 OF 4

THIS DOCUMENT CONTAINS PROPRIETARY INFORMATION AND SUCH INFORMATION MAY NOT BE DISCLOSED TO OTHERS FOR ANY PURPOSE OR USED FOR MANUFACTURING PURPOSES WITHOUT WRITTEN PERMISSION FROM AMPHENOL CANADA CORP.