

IB IL POS 200

Positioning CPU as Positioning Control System for Multi-Axis Point-to-Point Control Systems

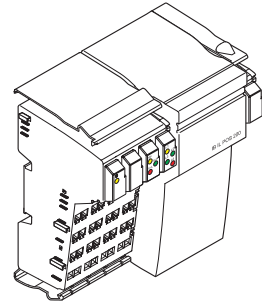

Data Sheet 6575A

06/2002

6575A000

Product Description

The modular positioning control system with IB IL POS 200 enables cost-effective solutions for many positioning tasks.

The IB IL POS 200 positioning CPU offers advantages with regard to costs and handling, especially for the automation of less dynamic axes with reduction gears, e.g.,

- In transport equipment (conveyor belts, cranes, chain and monorail conveyors)
- In tools (spindles, saw blades, cutting and bending tools) and for
- For set-up changes (setting of end stops, guideways or rollers)

The modular structure of the point-to-point control system allows economic configuration of any desired number of axes without the overhead typical for multi-channel control systems.

The IB IL POS 200 positioning CPU can be used to create modular and scalable control system solutions for point-to-point positioning according to the rapid motion/creeping motion principle. In combination with I/O terminals from the Inline automation kit control systems with up to ten axes can be set up.

IB IL POS 200 performs the control, which is completed per axis by one Inline terminal each for position detection and for drive control.

For both functions different detection and output terminals are available. For this reason the required interfaces for different sensors and drives can be combined easily for almost every positioning task.

This means: Using IB IL POS 200 allows the automation of up to ten axes for which the physics for the actual position detection and for the drive control from axis to axis may vary.

IB IL POS 200 supports positioning using AC and DC drives as well as hydraulic drives.

Features

- Distributed modular positioning terminal
- Positioning function with absolute target position specifications
- Positioning according to the rapid motion/ creeping motion principle
- No position controller, i.e., parameterization of control parameters not necessary
- Easy startup because only target range, shutdown range, pre-shutdown range etc. need adjustment
- Actual position detection via Inline terminal to be added, e.g., incremental rotary and linear encoders (IB IL INC-IN and IB IL SSI)
- Drive control via Inline terminals to be added, e.g., analog or binary outputs or drive amplifiers for DC motors
- Parameter records, which can be set independently per axis for the positioning behavior:
 - Target position
 - Target range
 - Shutdown range
 - Pre-shutdown range
- Independent positioning and homing of all axes
- Support of linear axes
- Automated homing to home position switch or limit switch (only for relative position detection, e.g., for IB IL INC-IN)
- Conversion of gear ratio
- Automatic gear backlash compensation due to parameterizable approach direction of target position
- Looping function
- Optional positioning repetition if target range could not be reached
- Step function logic for positioning distance
- Direct wiring to the creeping motion function (jog operation)
- Software limit position logic
- Hardware limit position logic
- Operator hand panel operation
- Switch-over times for contactors
- Switching behavior of outputs for different drive circuits (Dahlander in preparation/pole-reversing motors)
- Comprehensive positioning error diagnostics

Applications

Distributed modular positioning control system (functional units) in machines and systems.



This data sheet is only valid in association with the IB IL SYS PRO UM E "Configuring and Installing the INTERBUS Inline Product Range" User Manual (Order No. 27 43 04 8).

Structure

The positioning CPU has the following interfaces and indicators:

- 1 BDM interface
- 2 Diagnostic and status indicators

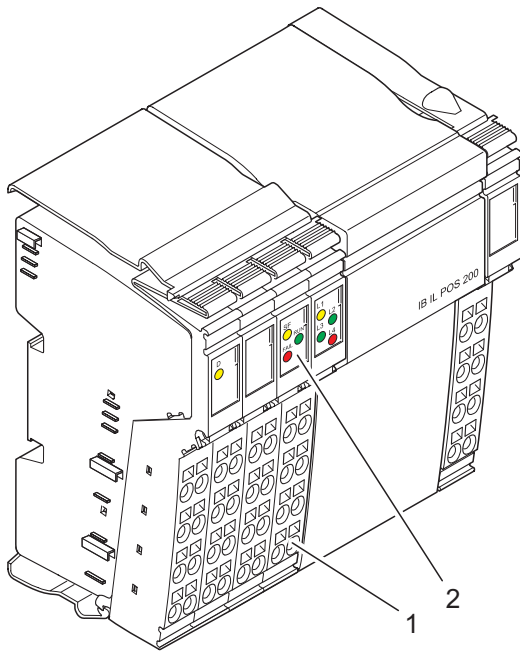

6575A001

Figure 1 Structure of the IB IL POS 200 positioning CPU

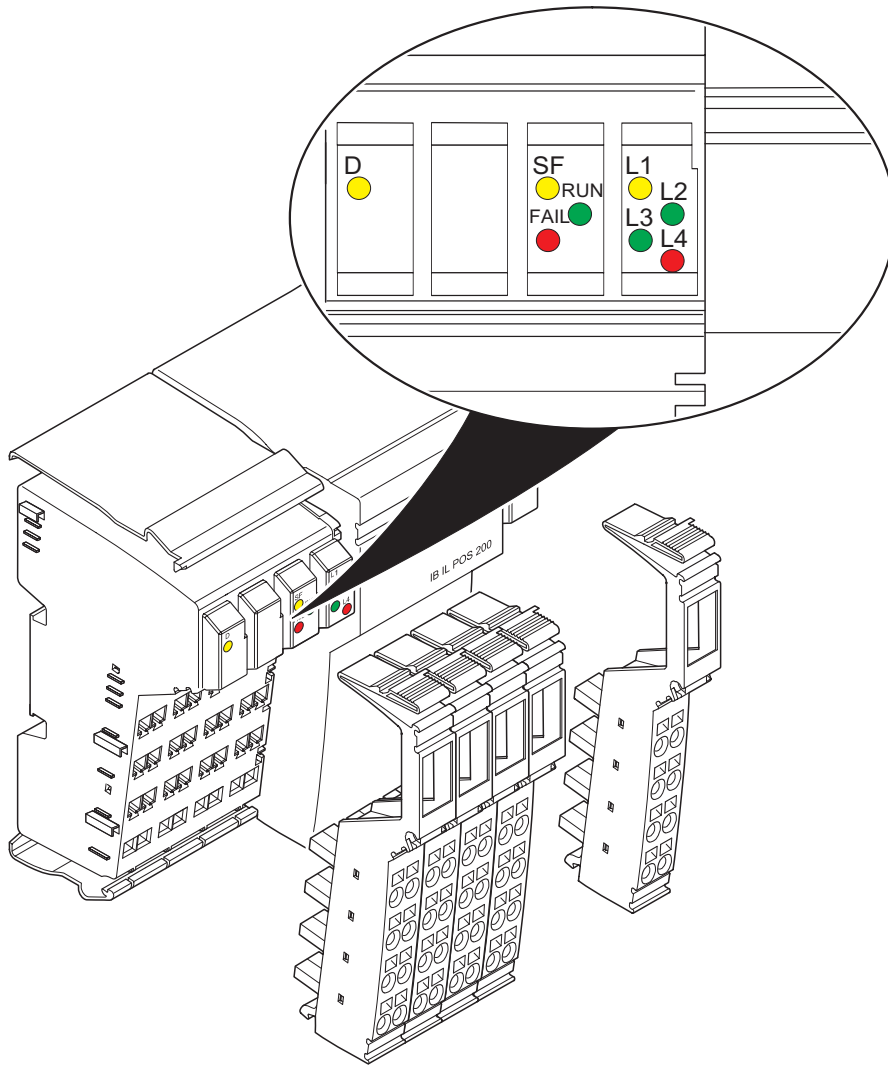

6575A002

Figure 2 IB IL POS 200 with appropriate connectors



The connectors are not supplied as standard with the module. To order these connectors, please refer to the "Ordering Data" on page 24.



In order for the positioning CPU to be supplied with voltage connect it to a bus terminal.

Local Diagnostic and Status Indicators

Des.	Color	Meaning
D	Yellow LED	Diagnostics higher-level bus
	ON:	Communications power present, module function error-free, bus active
	Flashing:	
	0.5 Hz: (slow)	Communications power present, bus not active
	2 Hz: (medium)	Communications power present, I/O error
	4 Hz: (fast)	Communications power present, cable interrupt before the module
	OFF:	No communications power
SF	Yellow LED	System failure
	ON:	The application CPU has run through a second reset after a power-on reset, check the application program
	OFF:	No error
RUN	Green LED	INTERBUS LED (INTERBUS running)
	ON:	The lower-level bus is ready to operate, data is being transmitted
	Flashing:	The lower-level bus is ready to operate, no data is being transmitted
	OFF:	The lower-level bus is not ready to operate.
FAIL	Red LED	Controller failure
	ON:	<ul style="list-style-type: none"> – Error in the lower-level bus (bus error) – Invalid command from the application program (user error) – Internal controller error
	OFF:	No error
L1	Yellow LED	Peripheral fault in the local bus
	ON:	Peripheral fault in the local bus; bus can still be operated
	OFF:	No peripheral fault
L2	Green LED	Transmit/receive PCP communication
	ON:	PCP communication with the higher-level control system
	OFF:	No PCP communication with the higher-level control system
L3	Green LED	Axis/axes ready to operate
	ON:	At least one axis is configured and ready to operate
	OFF:	No axis is configured and ready to operate
L4	Red LED	Error in bus configuration

Des.	Color	Meaning
	ON:	Error in bus configuration
	OFF:	No error in bus configuration



The connectors are not supplied as standard with the module. To order these connectors, please refer to the "Ordering Data" on page 24.

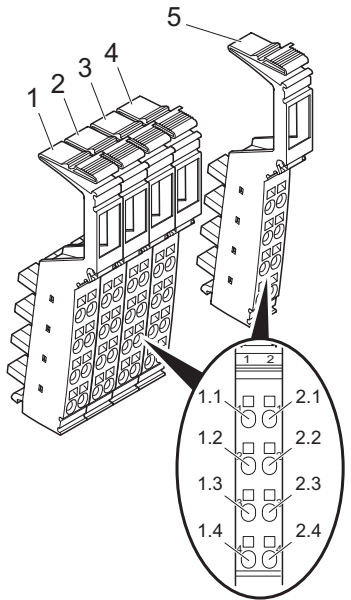

6575A016

- 1 Connector 1: Reserved
- 2 Connector 2: Reserved
- 3 Connector 3: BDM interface
- 4 Connector 4: BDM interface
- 5 Connector 5: Reserved

Figure 3 Terminal point assignment

Terminal Point	Assignment		Remark
Connector 1	Reserved		
Connector 2	Reserved		
Connector 3	BDM interface		
1.1, 2.1, 1.2, 2.2	–		Reserved
1.3	+5 V	Logic supply	Alternative power supply for the BDM box
2.3	LGND	Logic ground	
1.4, 2.4	–		Reserved
Connector 4	BDM interface		
			Only used for firmware updates
 Observe the necessary safety measures when handling components that may be damaged by electrostatic discharge.			
1.1	IFETCH		Data line to the processor. The signal is synchronized to the CLK on BKPT.
2.1	IPIPE		Data line to the processor. The signal is synchronized to the CLK on BKPT.
1.2	LGND	Logic ground	Not electrically isolated
2.2	RESET		The Reset signal resets the processor.
1.3	BKPT	Breakpoint signal	The CLK for the data is also transmitted via this signal.
2.3	FREEZE		The processor can be stopped with this signal.
1.4, 2.4	FE	Functional earth ground	
Connector 5	Reserved		



For connecting the BDM box to the BDM interface an interface cable is required (Order No. 28 19 19 2).

BDM Connection

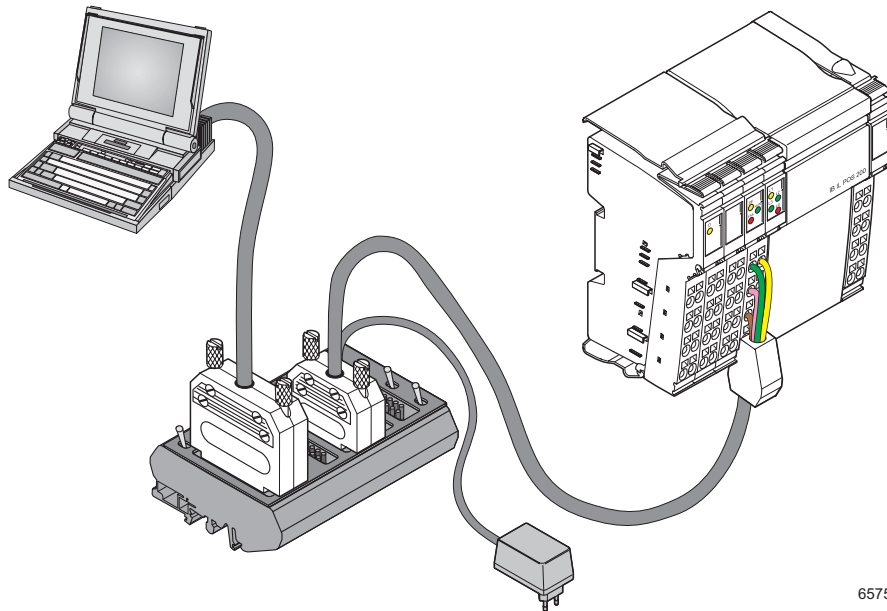

6575A004

Figure 4 Connection to a PC

The BDM connection is **only** used for firmware updates. In this way it is possible to meet future system requirements by means of updates.



The firmware for the positioning CPU is transferred upon delivery. In this way there is no need for programming except in the case of updates.

A BDM box is required for programming via the BDM interface. The BDM box includes the appropriate loader software, which currently can be run under DOS[®] or under Microsoft Windows[®] 95/98 in a DOS box. Under Microsoft Windows[®] NT, the program is downloaded directly from the software debugger.

Function

Positioning

In combination with the position detection terminals and the terminals for drive control the IB IL POS 200 positioning CPU enables point-to-point positioning according to the rapid motion/creeping motion principle. Using IB IL POS 200 up to ten axes can be set up in a modular way. The selected rapid motion/creeping motion method switches off the drives, which can be run in "rapid motion" and "creeping motion", when reaching the target position.

Positioning occurs in the way that the drive control is switched from rapid motion to creeping

motion and then to stop at pre-defined positions. Accuracies of up to $\pm 1 \mu\text{m}$ can be achieved depending on the mechanics.

The IB IL POS 200 control system switches off the drives in the target position. This is why in this case the drives do not provide a torque in the target position, in contrast to drives of positioning control systems with position controllers. This positioning method is used for applications in which the target position is retained mechanically (e.g., by a self-sustaining gear or brake).

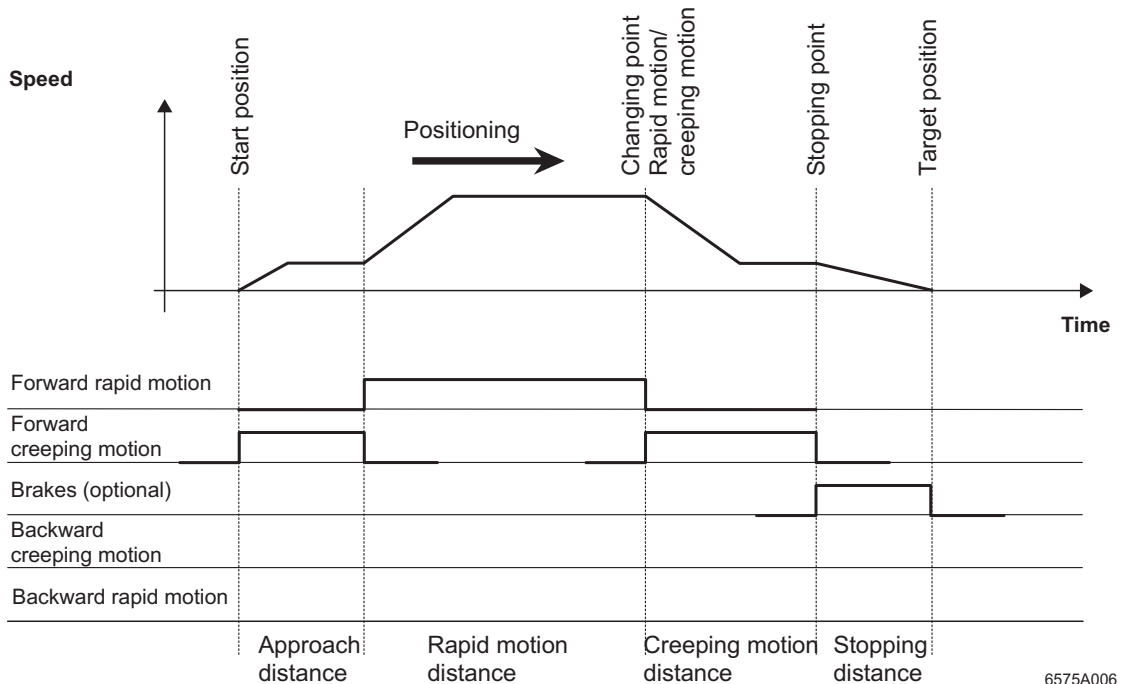

6575A006

Figure 5 States during positioning

Parameterizing Instead of Programming

Positioning is programmed in IB IL POS 200. These positioning functions can be flexibly parameterized to suit different positioning applications. For the user the positioning function of each axis is a function block providing four operating states:

- Positioning
- Jog operation
- Homing
- Step operation

The operating states of the function blocks for each axis are "remote-controlled" from the higher-level control system via the process data channel (8 bits per axis).

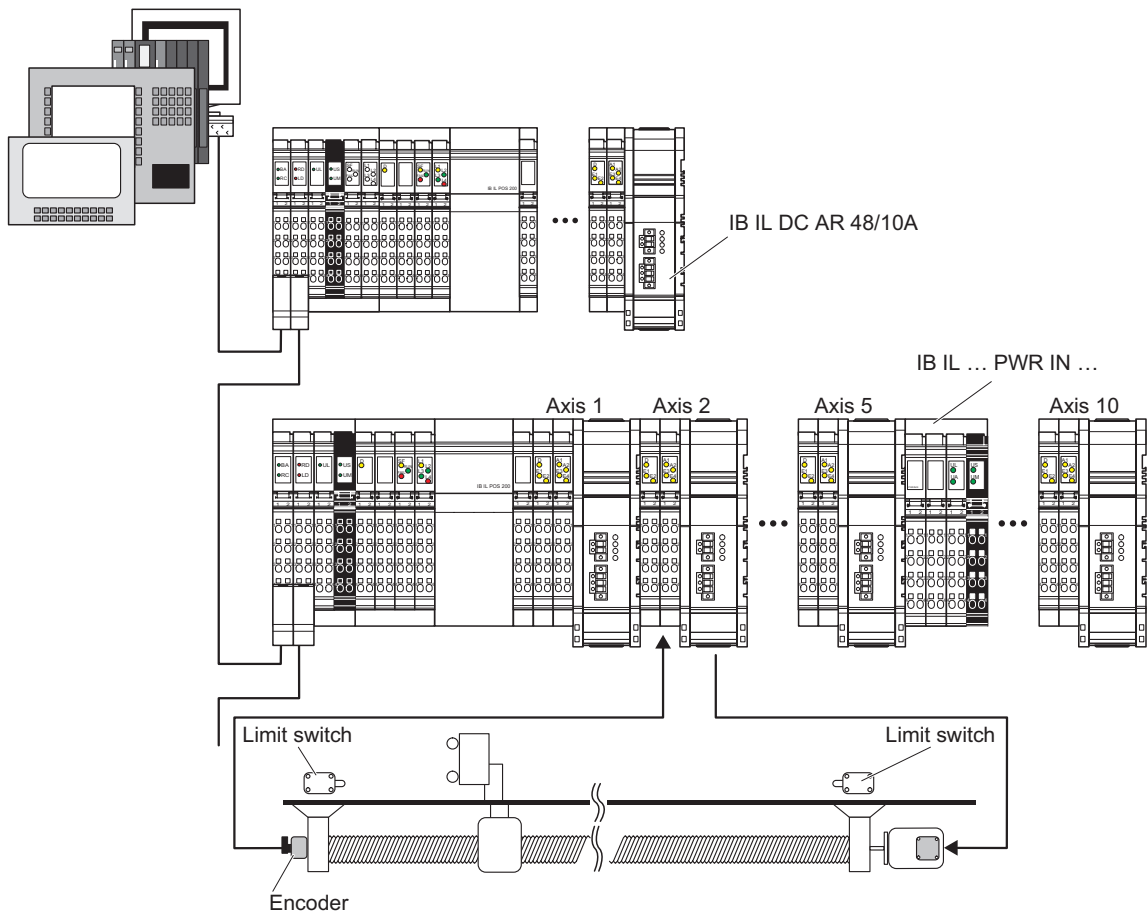

6575A014

Figure 6 Distributed modular positioning control system

Functions in Detail

IB IL POS 200 helps you when creating your positioning application by means of many practice-oriented detail functions.

Homing

(Only required for position detection by means of incremental encoders or sin/cos encoders)

During homing, the zero point signal (Z signal) is used to synchronize the actual value to a fixed parameterizable reference point in the positioning range. One of the hardware limit switches is used for homing.

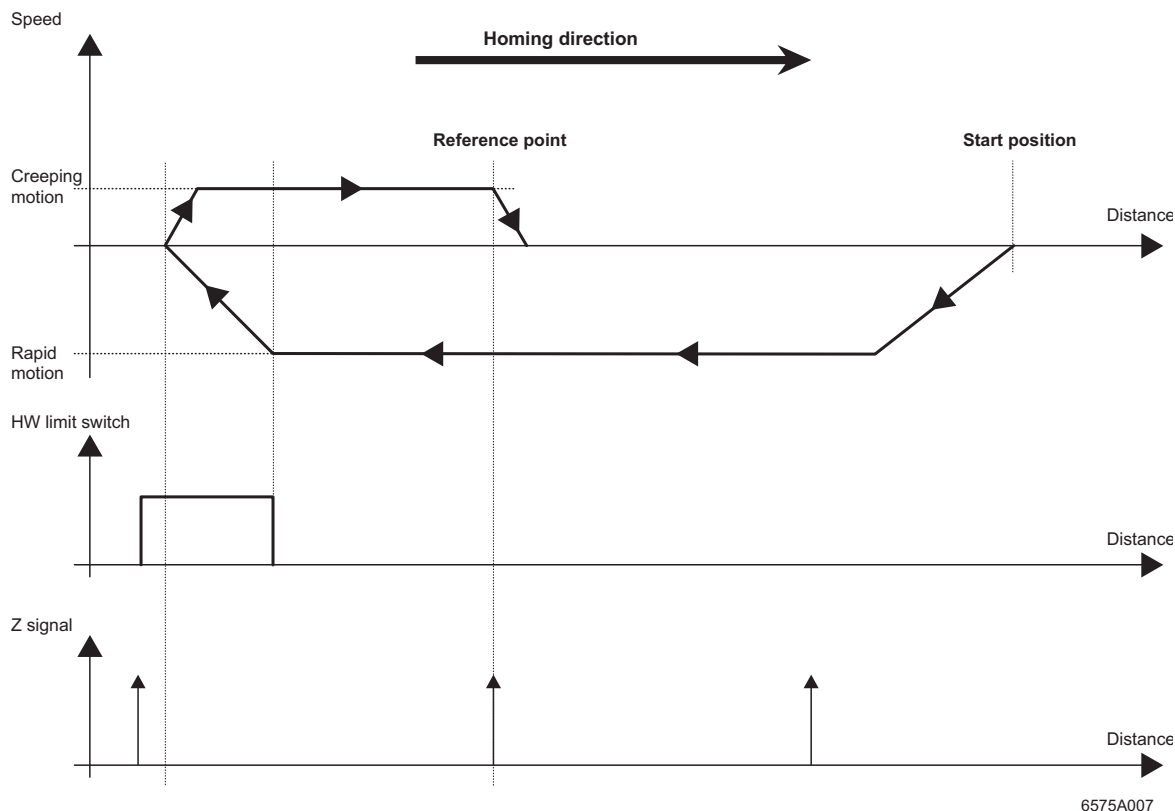

6575A007

Figure 7 Homing

Adjusting Value

(Only for incremental encoders)

Homing provides increments for the distance between the free calibration switch or limit switch and the zero point of the encoder.

This eliminates errors (zero point step changes) during homing.

The adjusting values must be evaluated by the higher-level control system.

Error Monitoring and Diagnostics

During positioning the following functions are monitored:

- Bus diagnostics
- Drive stop
- Wrong direction of rotation
- Z signal (A/B signal) (IB IL INC-IN only)
- Parity of SSI data (IB IL SSI only)
- Inadmissible parameters or control commands
- Overstepping the position of the software limit switch
- Reaching the target range

Diagnostics is carried out by means of optical error messages directly on the appropriate module and by means of status messages.

Backlash Compensation

Usually, drive systems have clearance, called "backlash" in practice. Every time the direction reverses, the backlash causes a motor rotation without changing the drive position. If the operating machine forces are only applied to an axis from one direction clearance compensation can be achieved by approaching the target position from the opposite direction.

In this way, the IB IL POS 200 positioning CPU enables position approaching always from the same direction by means of backlash compensation. The approach direction is specified by the home direction. Backlash compensation must be activated via the appropriate parameter.

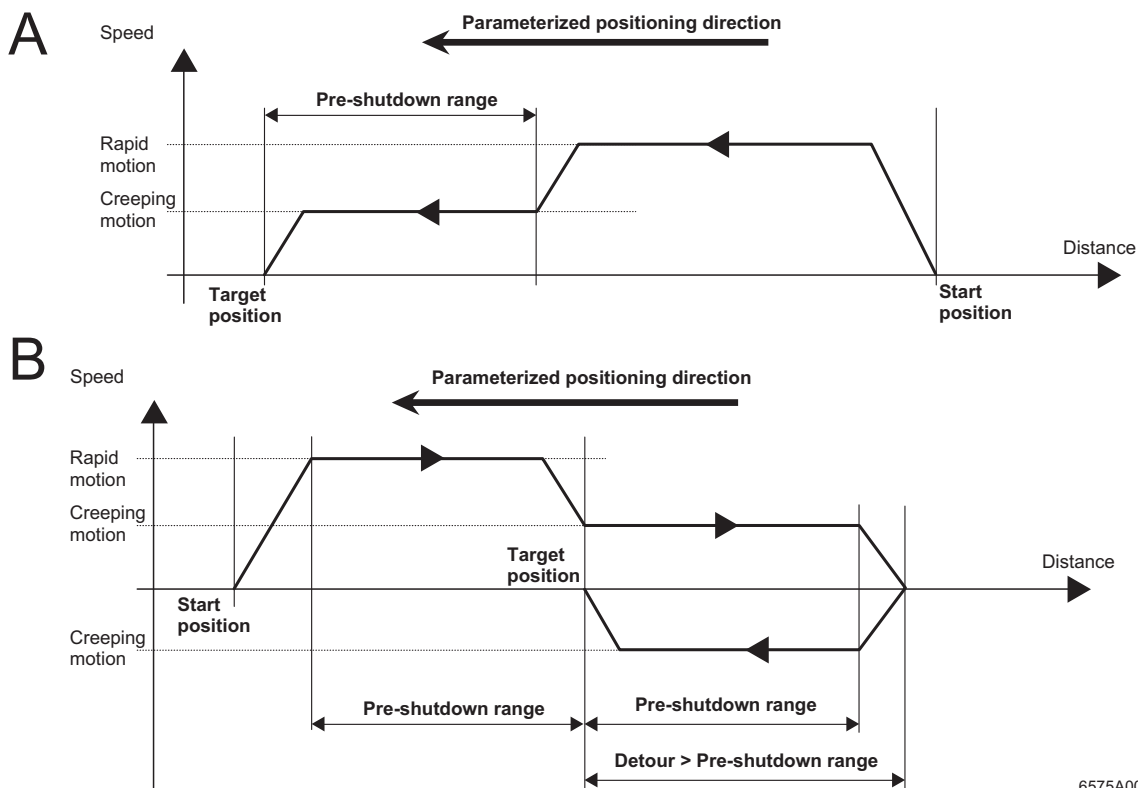

6575A008

Figure 8 Backlash compensation

- A** Target position can be directly approached in parameterized position direction
- B** Target position is in the opposite direction of parameterized position direction

Looping

If the difference between start and target position is smaller than the sum of start range and shutdown range it is not possible for point-to-point positioning control systems operating according to the rapid motion/creeping motion method to directly approach the target position. By means of looping the area around the target is left and then the target position is approached from a greater distance.

The traversing direction on exiting the target range is the opposite of the approach direction of the target position for active backlash compensation or of the defined approach direction for looping.

The direction of the loop is determined by the "Approach direction of the target position for active backlash compensation or looping" parameter. A new positioning is carried out according to the parameterization.

If looping is required to reach the target position, the terminal executes the process automatically, provided that looping is enabled. The current target position is only approached again once the drive has stopped.

Example

In Figure 9 on page 15, section A, the end position of the last positioning is the start position of the following positioning. This start position is within the sum of the start range and shutdown range. Therefore it cannot be approached directly.

The drive must be moved out of the start/shutdown range using looping. The end point of this looping is the start position for approaching the target position (Figure 9 on page 15, section B).

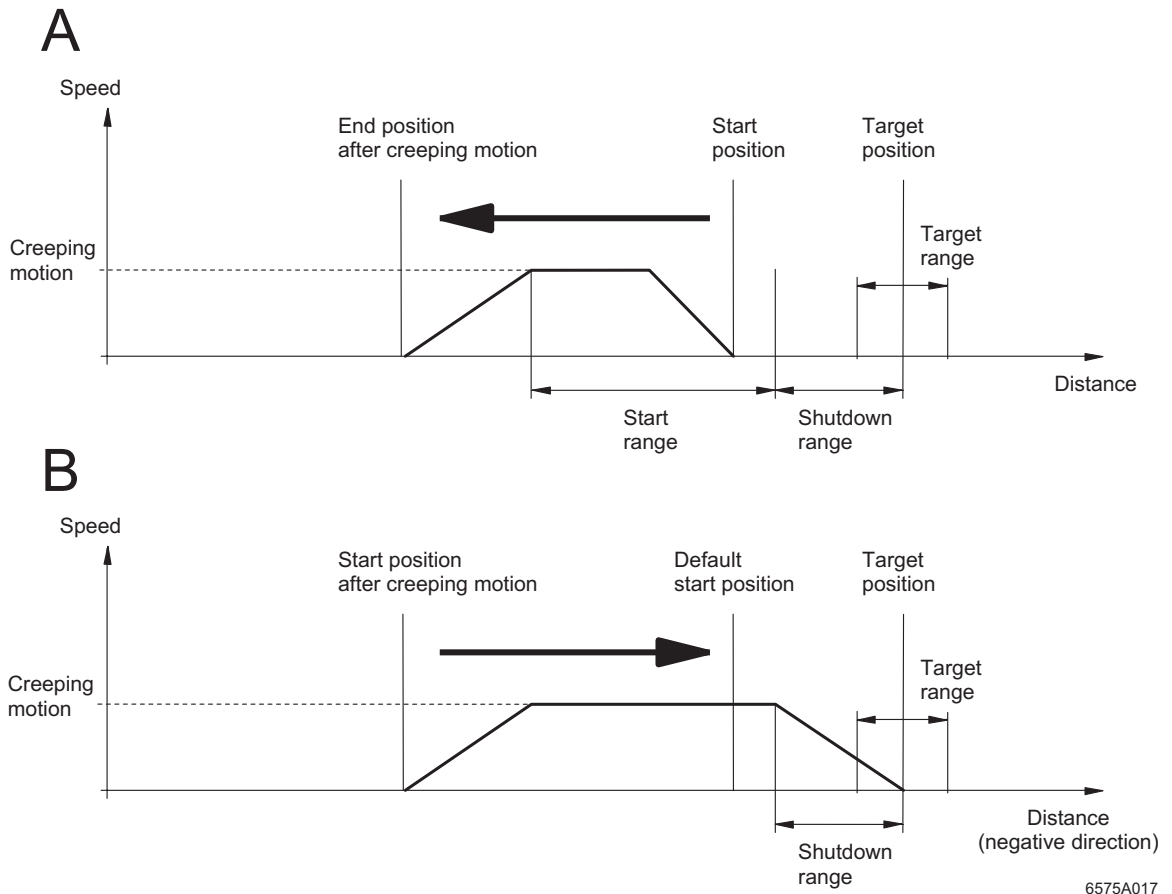

Figure 9 Looping

Step Operation (A)

During step operation the axis travels a defined distance (e.g., in micrometers) in traversing direction according to the rising edge of the control bit. Only after finishing step operation a new edge will be detected. The speed and the shutdown range can be parameterized for step operation.

Jog Operation (B)

In jog operation the axis travels in traversing direction as long as the control bit is applied.

Increment Evaluation

Incremental evaluation defines how many units of a measurement unit correspond to a certain number of increments.

Function Overview

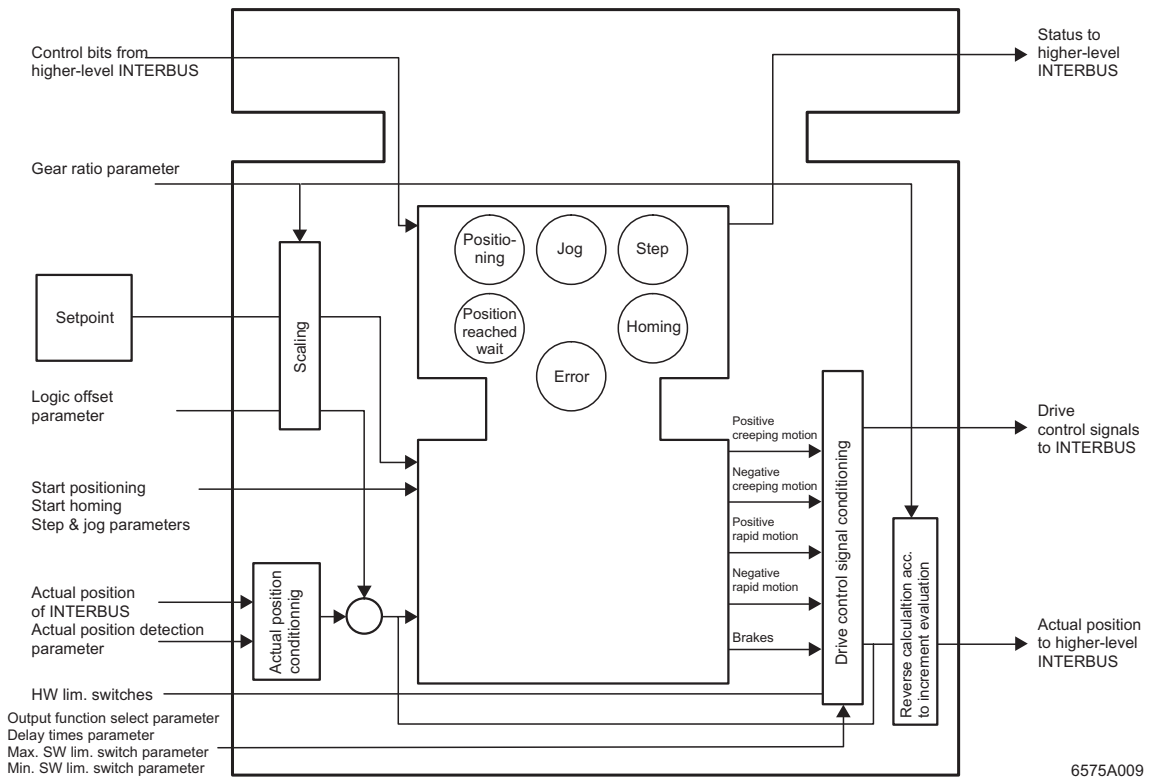
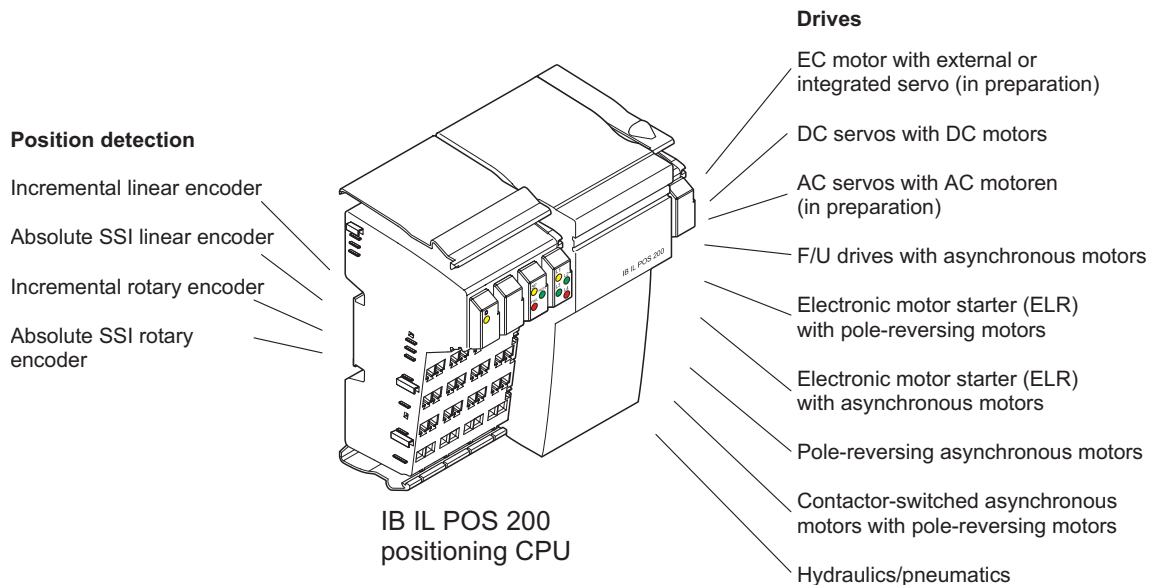

Figure 10 Function overview (according to DIN IEC 61499)

Point-to-Point Positioning Kit



6575A010

Figure 11 Point-to-point positioning

Depending on the type of drive there are three possibilities for dimensioning the control system:

- For asynchronous motors or pole-reversing motors digital output modules, type IB IL 24 DO 4, are used.
- Using analog modules, type IB IL AO 1/SF, defined speeds with signals from 0 V to 10 V are converted. This allows the use of any drives with variable speeds.
- For DC motors with brushgear the IB IL DC AR 48/10A drive controller is used due to increased demands on speed control and position accuracy.



All INTERBUS Inline bus terminals available supporting the PCP protocol can be used.

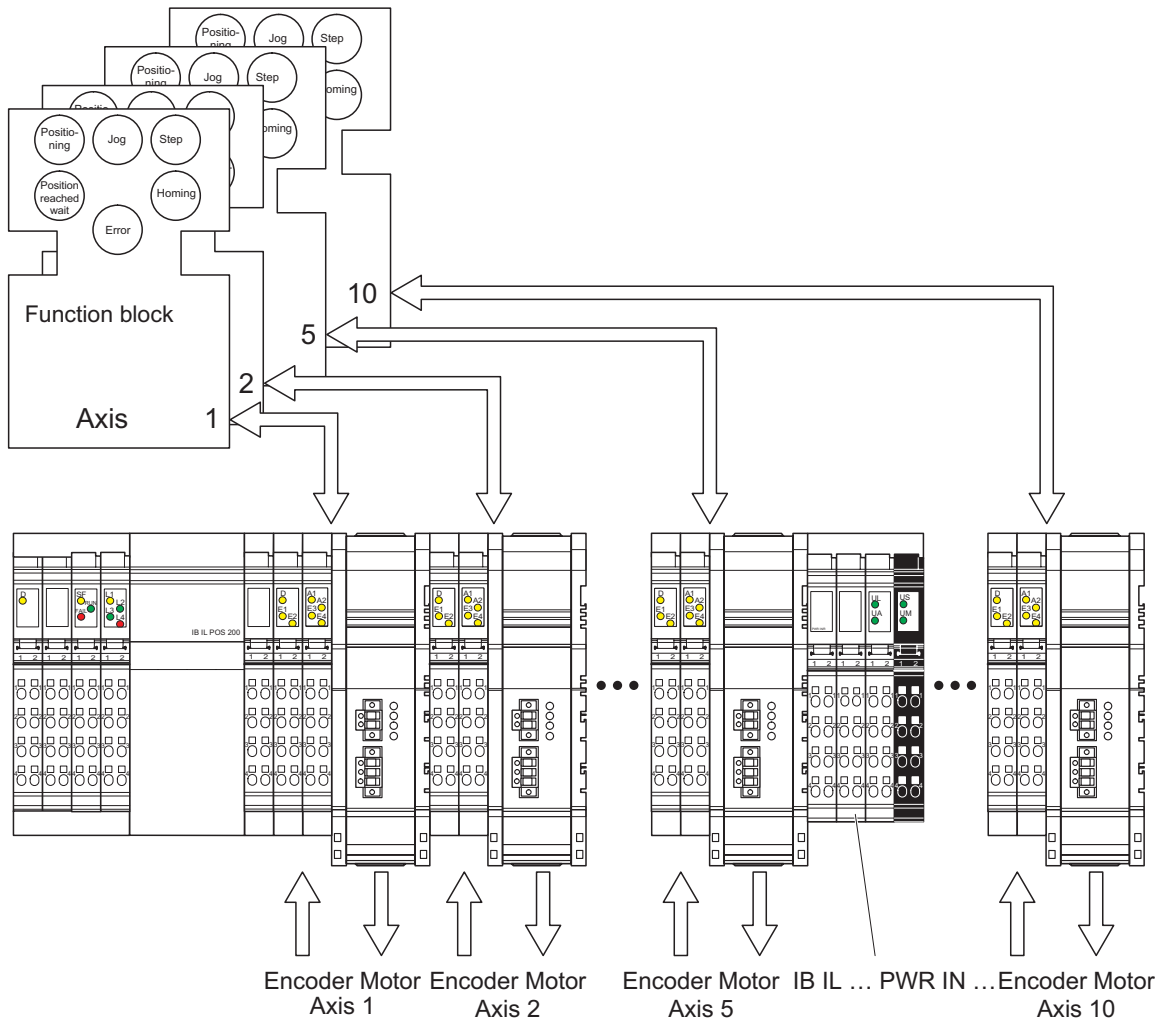

6575A011

Figure 12 Modular structure of a positioning control system with IB IL POS 200 and IB IL DC AR 48/10A

Position Detection

Modules IB IL INC-IN or IB IL SSI are used for position detection. Position and angle information of position encoders is directly read.

The positioning terminals are suitable for all standard signals. They are designed for connecting incremental and absolute position encoders. Both terminals supply the encoder with 5 V DC and 24 V DC.

Each terminal has three digital inputs with 24 V AC.

The terminals are configured and parameterized (encoder data, resolution, etc.) via INTERBUS and the positioning control system.

After the configuration the desired position values can be defined via the control program.

The module monitors the positioning and sends a status message to the control system. When an error occurs, the drive is stopped immediately. After configuration via INTERBUS both terminals operate independent of the bus, and control system.

Design and Performance of an Inline Positioning Control System

The position accuracy influenced by the control system is based on the bus cycle time t_{bus} . This bus cycle time is currently set to 6 ms.

$$\Delta_s [\mu\text{m}] = \frac{v [\text{m/min}]}{60} \cdot t_{bus} [\mu\text{s}]$$

Example:

In order to achieve a position accuracy of $\Delta_s = \pm 10 \mu\text{m}$ the target must be approached with the following creeping speed:

$$\begin{aligned} v [\text{m/min}] &= \frac{\Delta_s [\mu\text{m}]}{t_{bus} [\mu\text{s}]} \cdot 60 \\ &= \frac{10 \mu\text{m}}{6000 \mu\text{s}} \cdot 60 = 0.1 \text{ m/min} \end{aligned}$$

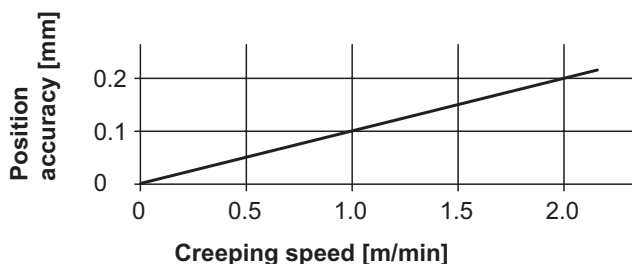

6575A021

Figure 13 Position accuracy

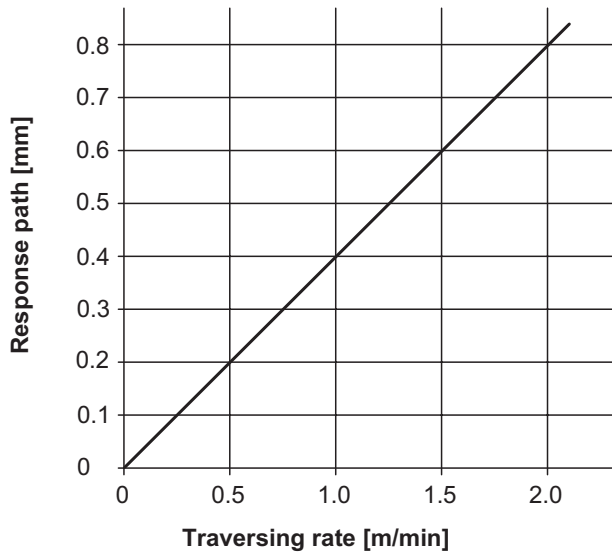

6575A022

Figure 14 Response path until a braking action is initiated after overrunning a limit switch



The response time to an **external** event (e.g., limit switch) is four times the scan time because a **constant** delay time (for input, processing, output) is taken into account.

The traversed distance until a braking action is initiated after overrunning a limit switch thus is:

$$s_{\text{react}} [\mu\text{m}] = \frac{v [\text{m/min}]}{60} \cdot 4 \cdot t_{\text{bus}} [\mu\text{s}]$$

In the above example ($v = 0.1 \text{ m/min}$) this means:

- Position accuracy:
 $\Delta s = \pm 10 \mu\text{m}$
- Response path for limit switch:
 $s_{\text{react}} = 40 \mu\text{m}$

Programming Data

Module ID	223 _{dec}
Number of process data words	5
Number of PCP words	1
Total data bus width	6 words
Operating mode	PCP and process data operation with the higher-level controller board
Electrical isolation	No

Technical Data

General Data	
Order designation	IB IL POS 200
Order no.	28 19 33 8
Dimensions (width x height x depth)	110 mm x 71.5 mm x 116.1 mm (4.330 in. x 2.815 in. x 4.571 in.)
Weight	400 g, approximately

BDM Interface	
Cable length to the BDM box	0.5 m (1.64 ft.), maximum
	Observe the necessary safety measures when handling components that may be damaged by electrostatic discharge.

Module Supply	
Communications Power (Voltage Jumper)	
Nominal value	7.5 V DC
Tolerance	±5%
Ripple	±1.5%

Module Supply	
Maximum current consumption	0.5 A
Communications Power (BDM)	
Nominal value	5 V DC
Tolerance	±5%
Ripple	±1.5%
Maximum current consumption	0.1 A

Bus Interface Lower-Level Bus	
Interface	Inline local bus
Electrical isolation	No
Maximum current of the bus terminal in the logic area	2 A
Number of devices of an Inline station	63, maximum
Number of I/O points	512
Number of PCP devices	10
Connection of Loop 2 devices	Via INTERBUS Loop 2 branch terminal

Optical Diagnostics	
INTERBUS	RUN, FAIL, D
Application processor	SF, L1, L2, L3, L4

Environmental Conditions	
Degree of protection	IP 20 (EN 60529:1991)
Temperature (according to EN 60204-1)	Operation: 0°C to 55°C (32°F to 131°F) (deviation from the Inline specifications) Storage and transport: -25°C to +75°C (-13°F to 167°F)
Humidity (according to EN 60204-1)	Storage and operation: 75% on average, 85% occasionally, (EN 60204-1); no condensation

Environmental Conditions	
Air pressure	Operation: 70 kPa to 108 kPa (up to 3000 m [9843 ft.] above sea level) Storage and transport: 66 kPa to 108 kPa (up to 3500 m [11483 ft.] above sea level)
Mechanical Demands (Deviation From the Inline Specifications)	
Vibration	2g, criterion 1 according to IEC 6006-2-6

Conformance With EMC Directive 89/336/EEC		
Noise Immunity Test According to EN 50082-2		
Electrostatic discharge (ESD)	EN 61000-4-2/IEC 61000-4-2	Criterion B 6 kV contact discharge 8 kV air discharge
Electromagnetic fields	ENV 50140 IEC 61000-4-3	Criterion A Field strength: 10 V/m
Fast transients (burst)	EN 61000-4-4/IEC 61000-4-4	Criterion B Supply lines: 2 kV Signal/data lines: 2 kV
Conducted interference	ENV 50141 IEC 61000-4-6	Criterion A Test voltage 10 V
Noise emission of housing	EN 55011	Class A

Ordering Data

Description	Order Designation	Order No.
Positioning CPU	IB IL POS 200	28 19 33 8
 You need 4 connectors for the terminal.		
Connector with eight connections, spring-clamp connection (green, w/o color print); pack of 10	IB IL SCN-8	27 26 33 7
Positioning CPU, with connectors and labeling fields	IB IL POS 200-PAC	28 61 82 3
"Configuring and Installing INTERBUS" User Manual	IBS SYS PRO INST UM E	27 43 80 2
"Configuring and Installing the INTERBUS Inline Product Range" User Manual	IB IL SYS PRO UM E	27 43 04 8
BDM cable	BDM CAB	28 19 19 2
BDM box	IBS BD32-ADAPTER	27 46 42 7

Phoenix Contact GmbH & Co. KG
 Flachsmarktstr. 8
 32825 Blomberg
 Germany



+ 49 - (0) 52 35 - 3-00



+ 49 - (0) 52 35 - 3-4 12 00



www.phoenixcontact.com



Worldwide locations:

www.phoenixcontact.com/salesnetwork