

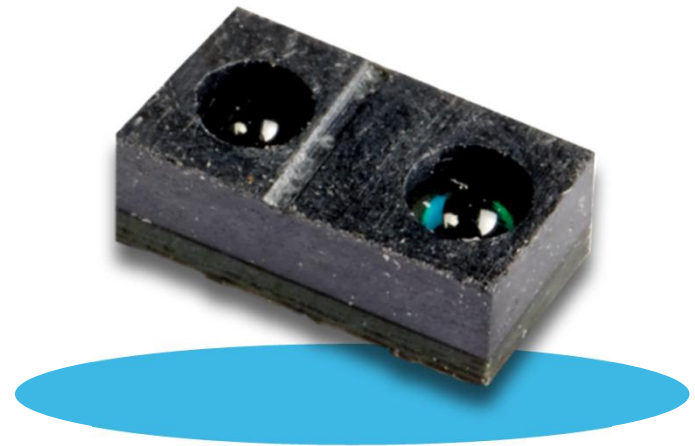

# Photologic<sup>®</sup> V

OPB9000 Reflective Sensor



# Real World Challenges



Sensors are exposed to a wide-range of ambient light levels

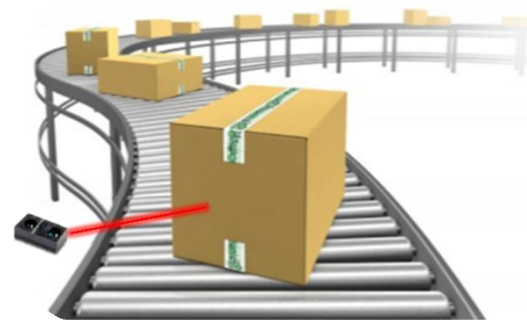

Reliable presence detection is needed to optimize efficiency

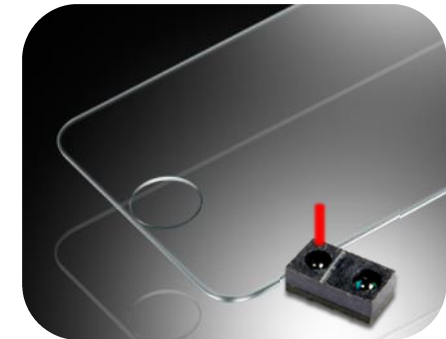

Detecting small changes in contrast or reflected light in various media is critical

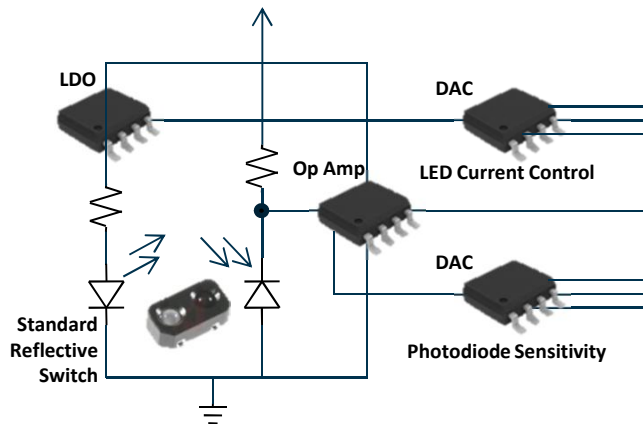

Standard analog circuits are extremely complex with added component costs

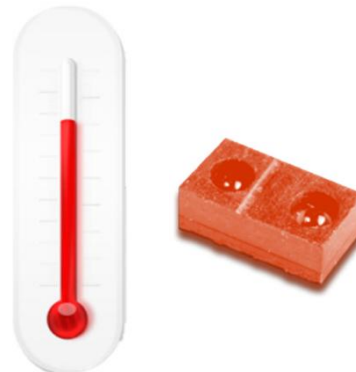

Reliable performance across a wide temperature range and dirty environments is critical

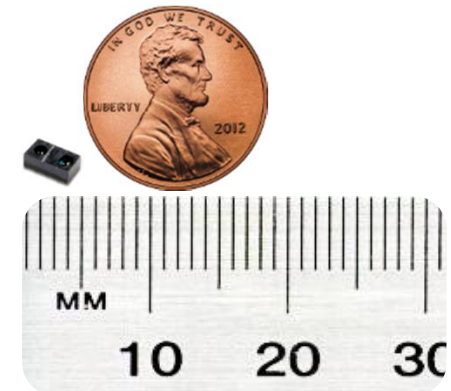

Space is limited as devices become smaller

# Introducing the OPB9000

Robust optical sensor operates well from bright sunlight to dark rooms

Integrated 850nm IR LED and synchronous LED driver

2.2mm

Small surface mount package fits in tight spaces

Industrial grade resin capable of -40 to +85C temperature range

Integrated design simplifies analog and digital circuit complexity

1.46mm

Embedded IC capable of being programmed easily and quickly

4.0mm

8-pin package provides application versatility

# OPB9000 Features

Robust IR LED and optical sensor with digital output

Surface mount package L 4.0mm x W 2.2mm x H 1.46mm

Superior ambient light immunity range up to full daylight

Fully-integrated analog front-end and digital interface

Programmable Output and Sensitivity Level

Self calibration and automatic gain control

Temperature-compensated LED drive

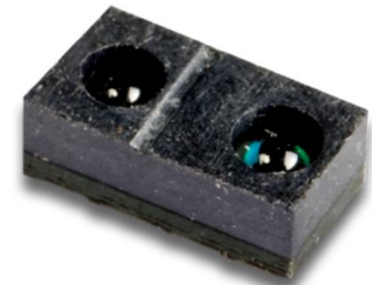

# OPB9000 Value Proposition

- Photologic® design heritage with over 35+ years and 10M+ units sold globally
- Robust, field-proven edge and presence detection avoids false readings

- Improves design efficiency with wide ambient light operational range
- Automatic gain control avoids the need to constantly recalibrate the device as the LED ages

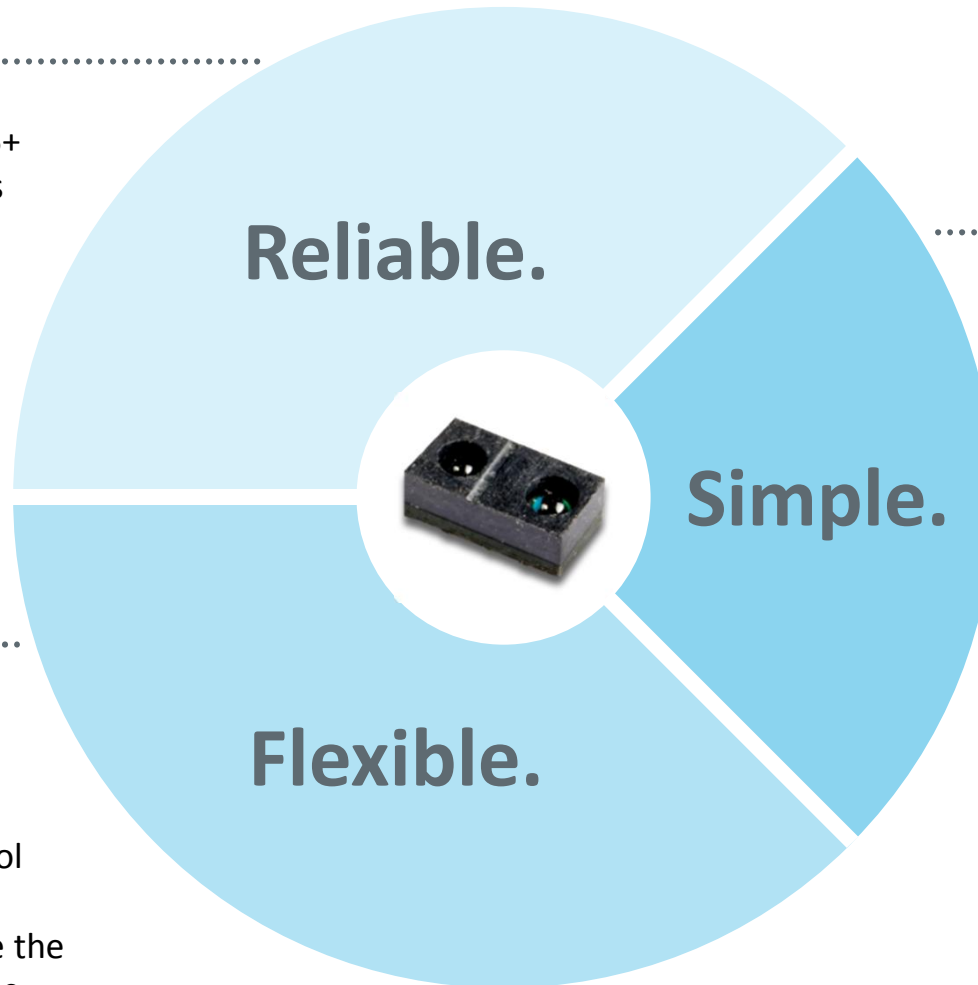

- 80% reduction in circuit complexity and board space requirements
- Eliminates need for circuit and sensor shielding
- Reduces number of sensors required in the system

# Case Study – Production Floor



Manufacturing and assembly machinery with dirty and high-temp conditions benefit from auto-calibration

Logistics require reliable presence detection for accurate routing

Engineers need smaller and simpler circuit designs with flexibility

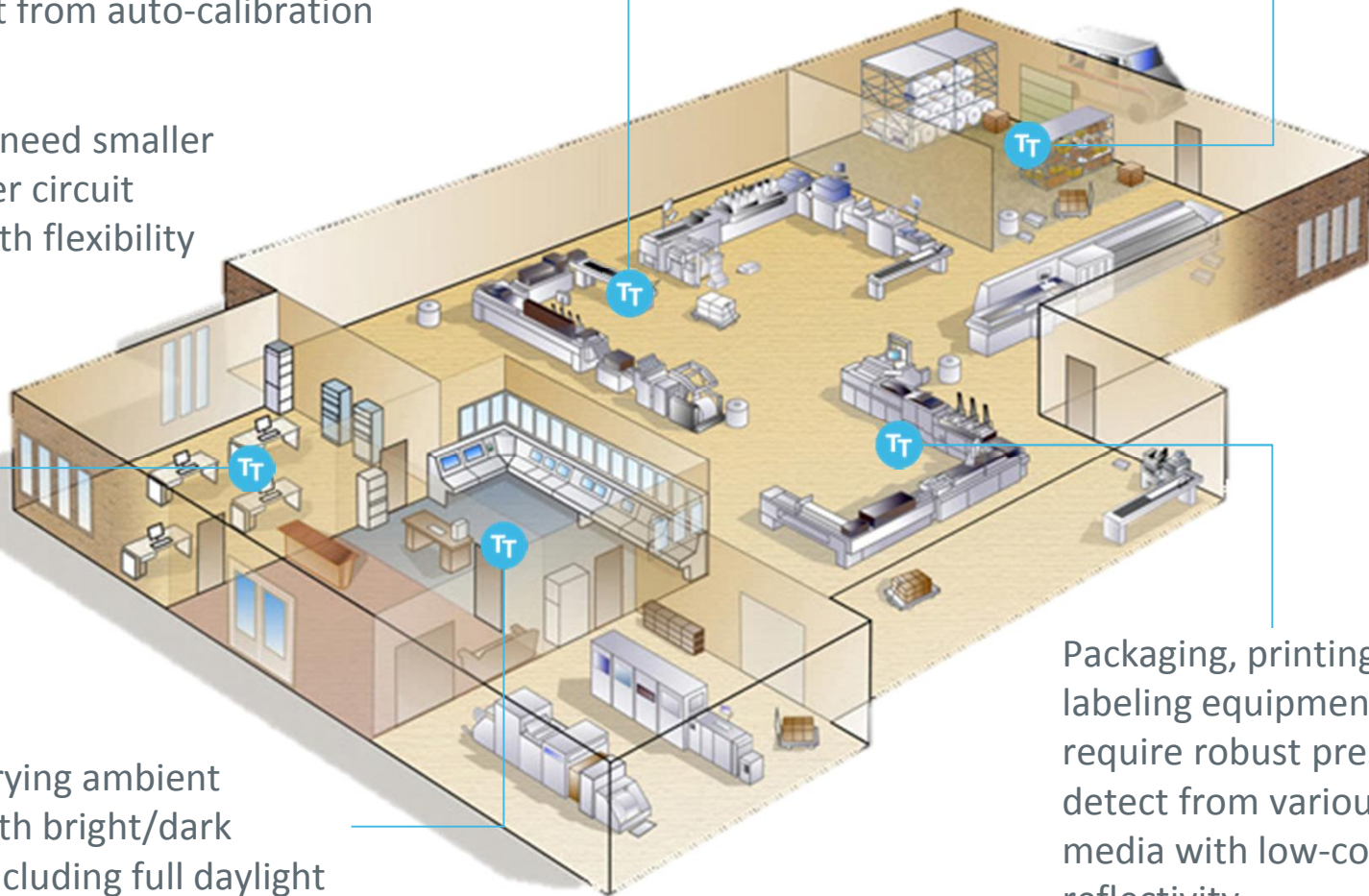





Widely varying ambient lighting with bright/dark periods, including full daylight

Packaging, printing, and labeling equipment require robust presence detect from various media with low-contrast reflectivity

# Competitive Landscape



	TT Electronics	Sharp	Hamamatsu	Vishay	Avago
					
Technical Specifications	OPB9000	GP2A25J0000F	S6846	VCNL3020-GS08	APDS-9190
Ambient Light Immunity (lux)	25k+	3k	10k	-	-
Operating Temp Range (°C)	-40 to +85	10 to +60	-25 to +60	-25 to +85	-30 to +85
Self Calibration & Automatic Gain Control	Yes	None	None	LED only	None
Temperature Compensation Circuit	Yes	No	No	-	-
Programmable Contrast Sensitivity	Yes	No	No	No	No
Calibration/Set-Up Time (ms)	32	-	-	>100	708
Response Time (us)	6	1000	800	>3000	>3000
Core Application	Industrial	Industrial	Industrial	Consumer	Consumer
Dynamic Range	1400:1	1:27	-	2000:1	2000:1
Supply Voltage Range (V)	2.7 to 5.5	4.75 to 5.25	4.5 to 16	2.5 to 3.6	2.5 to 3.6
Dimensions (mm)	4.0 x 2.2 x 1.5	33 x 10.0 x 9.0	21.7 x 5.2 x 2.0	4.9 x 2.4 x 0.83	3.94 x 2.36 x 1.35
Supply Current (mA)	3	30	11	4	3
Communication Interface	2-wire*	-	-	I <sup>2</sup> C	I <sup>2</sup> C
Reflective Sensing Range (mm)	50	9	-	200	100

\*One wire for 2-way communication based on [Manchester](#) interface protocol and one wire for output

**A field-proven, reliable reflective sensor for industrial and medical applications**

# Application Versatility – Industrial

## Printing & Dispensing



- Media presence
- Ink level and high-speed paper detection
- Maintenance notification

## Manufacturing



- Asset tracking
- Fault detection
- Non-contact position & edge sensing

## Security



- Intrusion detection
- Anti-tampering
- Media presence & currency/ticket dispensing



# Application Versatility – Medical

## Hospital & Lab Equip.



- Blood analysis
- Media detection
- Bubble or contamination detection

## Portable Equipment



- Bubble or contamination detection
- Cartridge and media presence
- Low contrast detection

## Dispensing

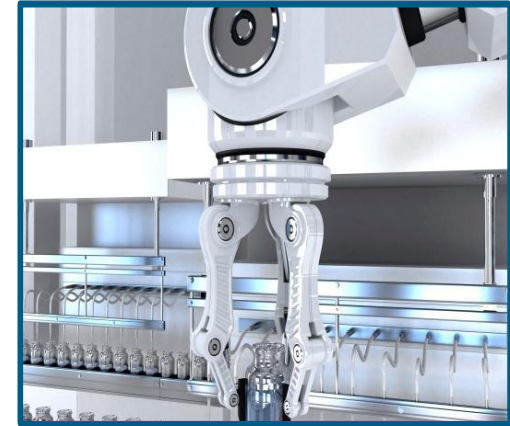

- Anti-tampering
- Counting
- Low reflectivity object detection



Thank You

