



Title	<i>Reference Design Report for a 12 W Power Supply Using TinySwitch™-III TNY278PG</i>
Specification	85-265 VAC Input, 12 V, 1 A Output
Application	TinySwitch-III Reference Design
Author	Applications Engineering Department
Document Number	RDR-91
Date	February 11, 2013
Revision	1.4

Summary and Features

- EcoSmart™ – Meets all existing and proposed harmonized energy efficiency standards including: CECP (China), CEC, EPA, AGO, European Commission
 - No-load consumption 140 mW at 265 VAC (no bias winding required)
 - >75% active-mode efficiency (exceeds standards requirement of 71%)
- BP/M capacitor value selects power MOSFET current limit for greater design flexibility
- Output overvoltage protection (OVP) using primary bias winding sensed shutdown feature
- Tightly toleranced I^2t parameter (-10%, +12%) reduces system cost
 - Increases MOSFET and magnetics power delivery
 - Reduces overload power, which lowers output diode and capacitor costs
- Integrated TinySwitch-III Safety/Reliability features
 - Accurate ($\pm 5\%$), auto-recovering, hysteretic thermal shutdown function maintains safe PCB temperatures under all conditions
 - Auto-restart protects against output short-circuit and open loop fault conditions
 - >3.2 mm creepage on package enables reliable operation in high humidity and high pollution environments
- Meets EN550022 and CISPR-22 Class B conducted EMI with >12 dB μ V margin
- Meets IEC61000-4-5 Class 3 AC line surge

The products and applications illustrated herein (including circuits external to the products and transformer construction) may be covered by one or more U.S. and foreign patents or potentially by pending U.S. and foreign patent applications assigned to Power Integrations. A complete list of Power Integrations' patents may be found at www.powerint.com.

Table of Contents

1	Introduction.....	4
2	Power Supply Specification	5
3	Circuit Diagram.....	6
4	Circuit Description	7
4.1	Input Rectification and Filtering	7
4.2	TNY278PG Operation	7
4.3	Output Rectification and Filtering	8
4.4	Feedback and Output Voltage Regulation.....	8
4.5	Output Overvoltage Shutdown	8
4.6	EMI Design Aspects	8
4.7	Peak Primary Current Limit Selection.....	9
4.8	Undervoltage Lockout	9
5	PCB Layout	10
6	Bill of Materials	11
7	Transformer Specification.....	12
7.1	Electrical Diagram	12
7.2	Electrical Specifications.....	12
7.3	Materials.....	12
7.4	Transformer Build Diagram	13
7.5	Transformer Construction.....	13
8	Transformer Design Spreadsheet.....	14
9	Performance Data	16
9.1	Efficiency	16
9.2	Active Mode CEC Measurement Data.....	17
9.3	No-load Input Power (R8 not installed: no bias winding supplementation).....	18
9.4	No-load Input Power (with R8 and bias winding supplementation).....	19
9.5	Available Standby Output Power	20
9.6	Regulation	21
9.6.1	Load and Line	21
10	Thermal Performance	22
11	Waveforms.....	23
11.1	Drain Voltage and Current, Normal Operation.....	23
11.2	Output Voltage Start-Up Profile	24
11.3	Drain Voltage and Current Start-Up Profile	24
11.4	Load Transient Response (75% to 100% Load Step)	25
11.5	Output Ripple Measurements.....	26
11.5.1	Ripple Measurement Technique	26
11.5.2	Measurement Results	27
11.6	Overvoltage Shutdown	27
12	Line Surge.....	28
13	Conducted EMI	29
13.1	115 VAC, Full Load	29
13.2	230 VAC, Full Load	30
14	Audible Noise.....	31



15	Extended and Reduced Current Limit (I_{LIMIT}) Operation	32
16	TNY277PG and TNY279PG Operation in RD-91	32
17	OVP Operation Verification	33
18	Revision History	34

Important Note:

Although this board was designed to satisfy safety isolation requirements, it has not been agency approved. Therefore, all testing should be performed using an isolation transformer to provide the AC input to the power supply.



1 Introduction

This report describes a universal input, 12 V, 1 A flyback power supply using a TNY278PG device from the TinySwitch-III family of ICs. It contains the complete specification of the power supply, a detailed circuit diagram, the entire bill of materials required to build the supply, extensive documentation of the power transformer, along with test data and oscillographs of the most important electrical waveforms. The board provides a number of user configurable options which are designed to demonstrate the features and flexibility of the TinySwitch-III family. These include easy adjustment of the device current limit for increased output power or higher efficiency operation, and a latched output overvoltage shutdown.

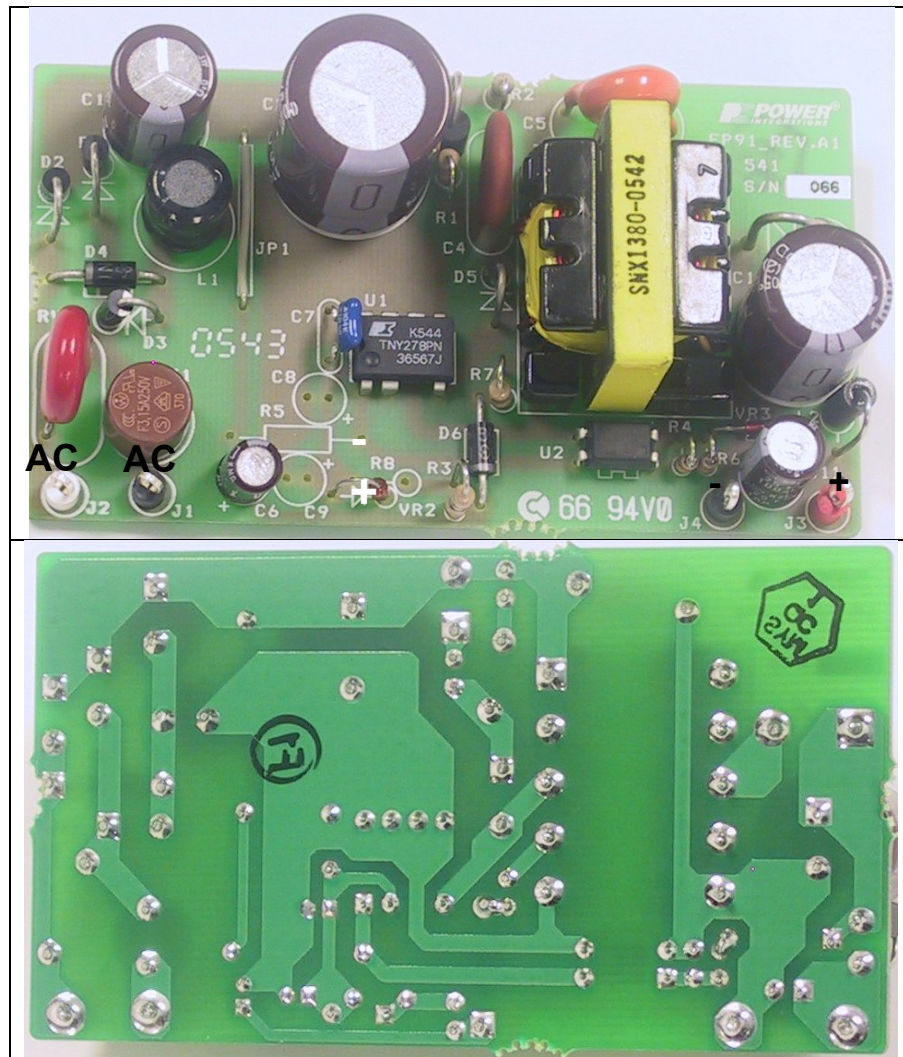

Figure 1 – RD-91 Populated Circuit Board Photographs.



2 Power Supply Specification

The table below represents the minimum acceptable performance of the design. Actual performance is listed in the results section.

Description	Symbol	Min	Typ	Max	Units	Comment
Input						
Voltage	V_{IN}	85		265	VAC	2 Wire – no P.E.
Frequency	f_{LINE}	47	50/60	64	Hz	
No-load Input Power (230 VAC)				0.15	W	w/o UVLO resistor or bias winding
No-load Input Power (230 VAC)				0.05	W	With bias winding support
Output						
Output Voltage	V_{OUT}	11	12	13	V	$\pm 8\%$
Output Ripple Voltage	V_{RIPPLE}			100	mV	20 MHz bandwidth
Output Current	I_{OUT}	1			A	
Total Output Power						
Continuous Output Power	P_{OUT}	12			W	
Overshoot Shutdown	V_{OV}	15		18	V	With bias sense
Efficiency						
Full Load	η	75			%	Measured at P_{OUT} 25 °C
Required average efficiency at 25, 50, 75 and 100 % of P_{OUT}	η_{CEC}	71.3			%	Per CEC / Energy Star STDs, with TNY278 & standard current limit
Environmental						
Conducted EMI						Meets CISPR22B / EN55022B
Safety						Designed to meet IEC950, UL1950 Class II
Surge (Differential)		1			kV	1.2/50 μ s surge, IEC 1000-4-5, Series Impedance:
Surge (Common mode)		2			kV	Differential Mode: 2 Ω Common Mode: 12 Ω
Ambient Temperature	T_{AMB}	0		50	°C	Free convection, sea level



3 Circuit Diagram

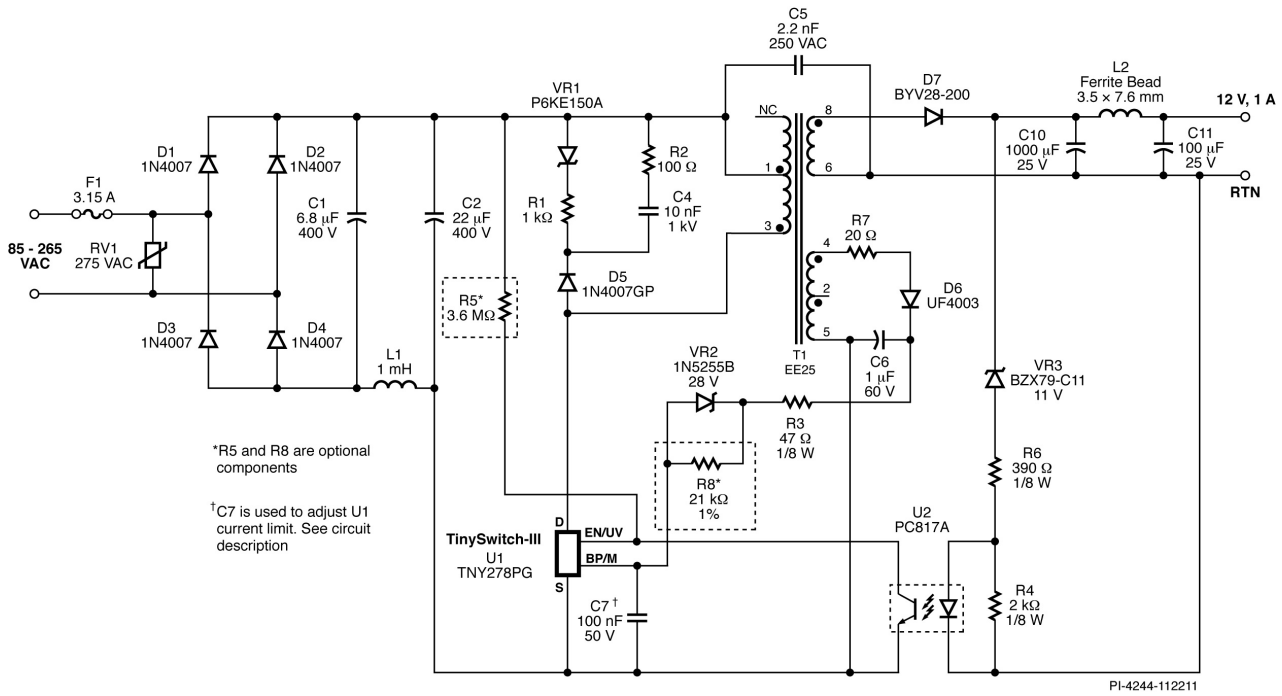

Figure 2 – Schematic.



4 Circuit Description

This flyback power supply was designed around the TNY278PG (U1 in Figure 2). The output voltage is sensed and fed back to U1 through optocoupler U2. That feedback is used by U1 to maintain constant voltage (CV) regulation of the output.

4.1 Input Rectification and Filtering

Diodes D1–D4 rectify the AC input. Capacitors C1 and C2 filter the rectified DC. Inductor L1, C1 and C2 form a pi filter that attenuates differential mode conducted EMI.

4.2 TNY278PG Operation

The TNY278PG device (U1) integrates an oscillator, a switch controller, startup and protection circuitry, and a power MOSFET, all on one monolithic IC.

One side of the power transformer (T1) primary winding is connected to the positive leg of C2, and the other side is connected to the DRAIN (D) pin of U1. At the start of a switching cycle, the controller turns the power MOSFET on, and current ramps up in the primary winding, which stores energy in the core of the transformer. When that current reaches the limit threshold, the controller turns the power MOSFET off. Due to the phasing of the transformer windings and the orientation of the output diode, the stored energy then induces a voltage across the secondary winding, which forward biases the output diode, and the stored energy is delivered to the output capacitor. When the power MOSFET turns off, the leakage inductance of the transformer induces a voltage spike on the drain node. The amplitude of that spike is limited by an RCD clamp network that consists of D5, C4 and R2. Resistor R1 and VR1 provide hard clamping of the drain voltage, only conducting during output overload. Resistor R2 also limits the reverse current that flows through D5 when the power MOSFET turns on. This allows a slow, low-cost, glass passivated diode (with a recovery time of $\leq 2 \mu\text{s.}$) to be used for D5, which improves conducted EMI and efficiency.

Using ON/OFF control, U1 skips switching cycles to regulate the output voltage, based on feedback to its ENABLE/UNDERVOLTAGE (EN/UV) pin. The EN/UV pin current is sampled, just prior to each switching cycle, to determine if that switching cycle should be enabled or disabled. If the EN/UV pin current is $< 115 \mu\text{A}$, the next switching cycle begins, and is terminated when the current through the MOSFET reaches the internal current limit threshold. To evenly spread switching cycles, preventing group pulsing, the EN/UV pin threshold current is modulated between $115 \mu\text{A}$ and $60 \mu\text{A}$ based on the state during the previous cycle. A state-machine within the controller adjusts the MOSFET current limit threshold to one of four levels, depending on the load being demanded from the supply. As the load on the supply drops, the current limit threshold is reduced. This ensures that the effective switching frequency stays above the audible range until the transformer flux density is low. When the standard production technique of dip varnishing is used for the transformer, audible noise is practically eliminated.



4.3 Output Rectification and Filtering

Diode D7 rectifies the output of T1. Output voltage ripple was minimized by using a low ESR capacitor for C10 (see Section 6 for component part numbers and values). A post filter (ferrite bead L2 and C11) attenuates the high frequency switching noise.

4.4 Feedback and Output Voltage Regulation

The supply's output voltage regulation set point is set by the voltage that develops across Zener diode VR3, R6 and the LED in optocoupler U2. The value of R4 was calculated to bias VR3 to about 0.5 mA when it goes into reverse avalanche conduction. This ensures that it is operating close to its rated knee current. Resistor R6 limits the maximum current during load transients. The values of R4 and R6 can both be varied slightly to fine-tune the output regulation set point. When the output voltage rises above the set point, the LED in U2 becomes forward biased. On the primary-side, the photo-transistor of U2 turns on and draws current out of the EN/UV pin of U1. Just before the start of each switching cycle, the controller checks the EN/UV pin current. If the current flowing out of the EN/UV pin is greater than 115 μ A, that switching cycle will be disabled. As switching cycles are enabled and disabled, the output voltage is kept very close to the regulation set point. For greater output voltage regulation accuracy, a reference IC such as a TL431 can be used in place of VR3.

4.5 Output Overvoltage Shutdown

The TinySwitch-III family of ICs can detect overvoltage on the output of the supply and latch off. This protects the load in an open feedback loop fault condition, such as the failure of the optocoupler. Overvoltage on the output is detected through the BYPASS/MULTI-FUNCTION (BP/M) pin and the bias winding on the transformer. The bias winding voltage is determined by the reflection of the output voltage through the turns ratio of the transformer. Therefore, an overvoltage on the output will be reflected onto the bias winding. The overvoltage threshold is the sum of the breakdown voltage of Zener diode VR2 and the BP/M pin voltage (28 V + 5.8 V). If the output voltage becomes abnormally high, the voltage on the bias winding will exceed the threshold voltage and excess current will flow into the BP/M pin. The latching shutdown circuit is activated when current into the BP/M pin exceeds 5 mA. Resetting a latched shutdown requires removing the AC input from the supply long enough to allow the input capacitors (C1 and C2) to discharge, and the BP/M pin voltage to drop below 2 V. Resistors R7 and R3 provide additional filtering of the bias voltage, with R3 also limiting the maximum current into the BYPASS pin in an OV condition

4.6 EMI Design Aspects

An input pi filter (C1, L1 and C2) attenuates conducted, differential mode EMI noise. Shielding techniques (E-Shield™) were used in the construction of T1 to reduce common mode EMI displacement currents. Resistor R2 and capacitor C4 dampen out some of the high frequency ringing that occurs when the power MOSFET turns off. When combined with the IC's frequency jitter function, these techniques produce excellent conducted and radiated EMI performance (see Section 12 of this report).



4.7 Peak Primary Current Limit Selection

The value of the capacitor installed on the BP/M pin allows the current limit of U1 to be selected. The power supply designer can change the current limit of the power MOSFET by simply changing the capacitance value connected to the BP/M pin (see the TinySwitch-III data sheet for more details).

- Installing a 0.1 μF capacitor on the BP/M pin selects the standard current limit of the IC, and is the normal choice for enclosed adapter applications.
- Installing a 1 μF capacitor on the BP/M pin reduces the power MOSFET current limit, which lowers conduction losses and improves efficiency (at the expense of reducing the maximum power capability of the IC).
- A 10 μF capacitor on the BP/M pin will raise the power MOSFET current limit and extend the power capability of the IC (for higher power applications that do not have the thermal constraints of an enclosed adapter, or to supply short-duration, peak load demands).

The EP91 demonstration board comes with a 0.1 μF capacitor installed as C7, which causes U1 to select the standard current limit specified in the TinySwitch-III data sheet. If C7 were replaced by a 1 μF capacitor (C8 in the BOM, section 6), the current limit of U1 will be the same as the standard current limit for a TNY277 device. If a 10 μF capacitor is installed, the current limit of U1 will be the same as the standard current limit for a TNY279 device. The flexibility of this option enables the designer to do three things. First, it allows the designer to measure the effect of switching to an adjacent device without actually removing and replacing the IC. Second, it allows a larger device to be used with a lower current limit, for higher efficiency. Third, it allows a smaller device to be used with a higher current limit in a design when higher power is not required on a continual basis, which effectively lowers the cost of the supply.

4.8 Undervoltage Lockout

The RD-91 circuit board has a location where an optional undervoltage (UV) lockout detection resistor (R5) can be installed. When installed, MOSFET switching is disabled at start-up until current into the EN/UV pin exceeds 25 μA . This allows the designer to set the input voltage at which MOSFET switching will be enabled by choosing the value of R5. For example, a value of 3.6 $\text{M}\Omega$ requires an input voltage of 65 VAC (92 VDC across C2) before the current into the EN/UV pin exceeds 25 μA . The UV detect function also prevents the output of the power supply from glitching (trying to restart) after output regulation is lost (during shutdown), by disabling MOSFET switching until the input voltage rises above the undervoltage lockout threshold.



5 PCB Layout

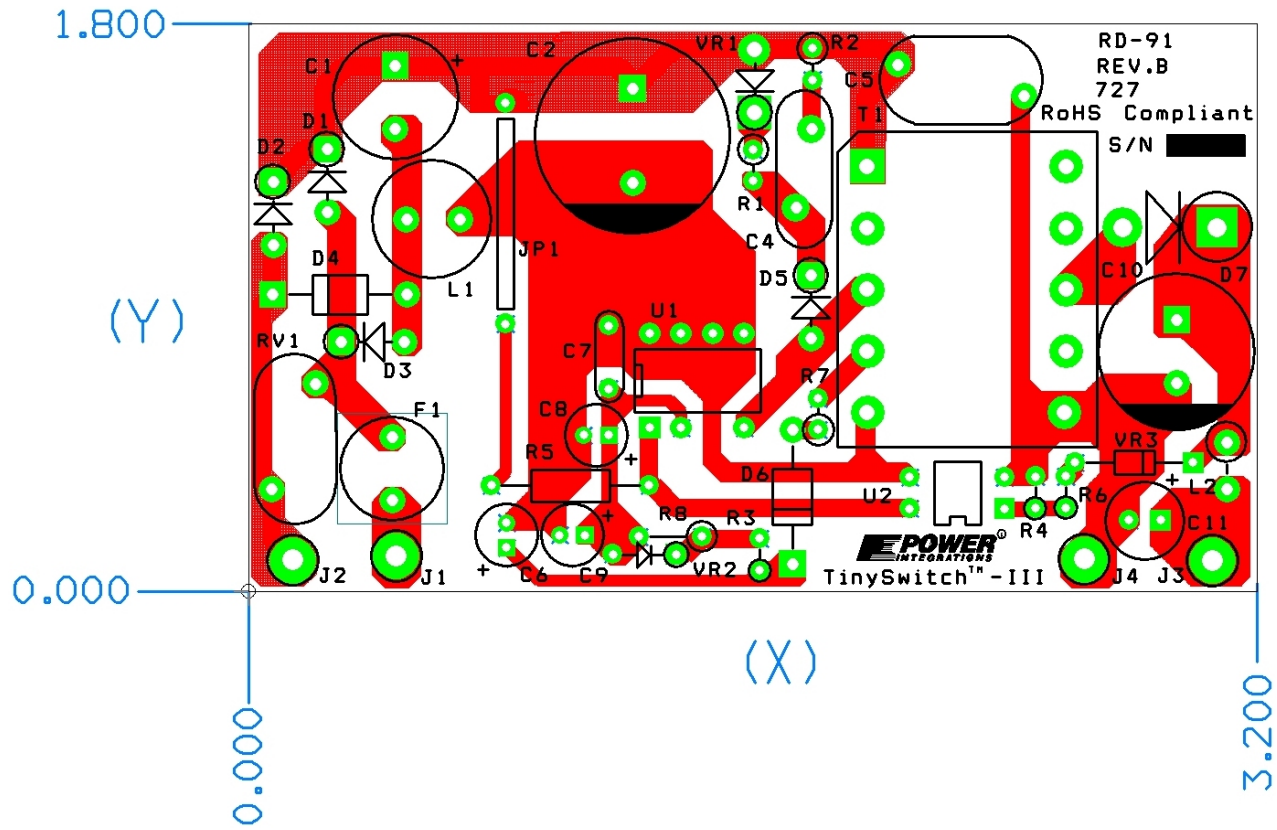

Figure 3 – Printed Circuit Board Layout (3.2 × 1.8 inches).



6 Bill of Materials

Item	Qty	Ref Des	Description	Mfg Part Number	Mfg
1	1	C1	6.8 μ F, 400 V, Electrolytic, (10 x 16),	EKXG401ELL6R8MJ16S	Nippon Chemi-Con
2	1	C2	22 μ F, 400 V, Electrolytic, Low ESR, 901 m Ω , (16 x 20)	EKMX401ELL220ML20S	Nippon Chemi-Con
3	1	C4	10 nF, 1 kV, Disc Ceramic	562R5HKMS10	Vishay
4	1	C5	2.2 nF, Ceramic, Y1	440LD22-R	Vishay
5	2	C6 C8*	1 μ F, 50 V, Electrolytic, Gen. Purpose, (5 x 11)	EKMG500ELL1R0ME11D	Nippon Chemi-Con
6	1	C7	100 nF, 50 V, Ceramic, X7R	B37987F5104K000	Epcos
7	1	C9*	10 μ F, 50 V, Electrolytic, Gen. Purpose, (5 x 11)	EKMG500ELL100ME11D	Nippon Chemi-Con
8	1	C10	1000 μ F, 25 V, Electrolytic, Very Low ESR, 21 m Ω , (12.5 x 20)	EKZE250ELL102MK20S	Nippon Chemi-Con
9	1	C11	100 μ F, 25 V, Electrolytic, Very Low ESR, 130 m Ω , (6.3 x 11)	EKZE250ELL101MF11D	Nippon Chemi-Con
10	4	D1 D2 D3 D4	1000 V, 1 A, Rectifier, DO-41	1N4007-E3/54	Vishay
11	1	D5	1000 V, 1 A, Rectifier, Glass Passivated, 2 μ s, DO-41	1N4007GP	Vishay
12	1	D6	200 V, 1 A, Ultrafast Recovery, 50 ns, DO-41	UF4003-E3	Vishay
13	1	D7	200 V, 3.5 A, Ultrafast Recovery, 25 ns, SOD64	BYV28-200	Vishay
14	1	F1	3.15 A, 250 V, Fast, TR5	37013150410	Wickman
15	2	J1 J4	Test Point, BLK, THRU-HOLE MOUNT	5011	Keystone
16	1	J2	Test Point, WHT, THRU-HOLE MOUNT	5012	Keystone
17	1	J3	Test Point, RED, THRU-HOLE MOUNT	5010	Keystone
18	1	JP1	Wire Jumper, Non insulated, #22 AWG, 0.7 in	298	Alpha
19	1	L1	1 mH, 350 mA	HTB2-102-281	
20	1	L2	3.5 mm x 7.6 mm, 75 Ω at 25 MHz, #22 AWG hole, Ferrite Bead	2743004112	Fair-Rite
21	1	R1	1 k Ω , 5%, 1/4 W, Carbon Film	CFR-25JB-1K0	Yageo
22	1	R2	100 Ω , 5%, 1/4 W, Carbon Film	CFR-25JB-100R	Yageo
23	1	R3	47 Ω , 5%, 1/8 W, Carbon Film	CFR-12JB-47R	Yageo
24	1	R4	2 k Ω , 5%, 1/8 W, Carbon Film	CFR-12JB-2K0	Yageo
25	1	R5*	3.6 M Ω , 5%, 1/4 W, Carbon Film	CFR-25JB-3M6	Yageo
26	1	R6	390 Ω , 5%, 1/8 W, Carbon Film	CFR-12JB-390R	Yageo
27	1	R7	20 Ω , 5%, 1/4 W, Carbon Film	CFR-25JB-20R	Yageo
28	1	R8*	21 k Ω , 1%, 1/4 W, Metal Film	MFR-25FBF-21K0	Yageo
29	1	RV1	275 V, 45 J, 10 mm, RADIAL	V275LA10P	Littlefuse
30	1	T1	Bobbin, 10 Pins, Vertical Transformer	YW-360-02B SNX-R1380	Yih-Hwa Enterprises Santronics USA
31	1	U1	TinySwitch-III, DIP-8C	TNY278PG	Power Integrations
32	1	U2	Optocoupler, 80 V, CTR 80-160%, 4-DIP	PS2501-1-H-A	NEC
33	1	VR1	150 V, 600 W, 5%, TVS, DO204AC (DO-15)	P6KE150A	LittleFuse
34	1	VR2	28 V, 5%, 500 mW, DO-35	1N5255B-T	Diodes, Inc.
35	1	VR3	11 V, 500 mW, 5%, DO-35	BZX79C11	Vishay

* Optional components

Note – All parts are RoHS compliant



7 Transformer Specification

7.1 Electrical Diagram

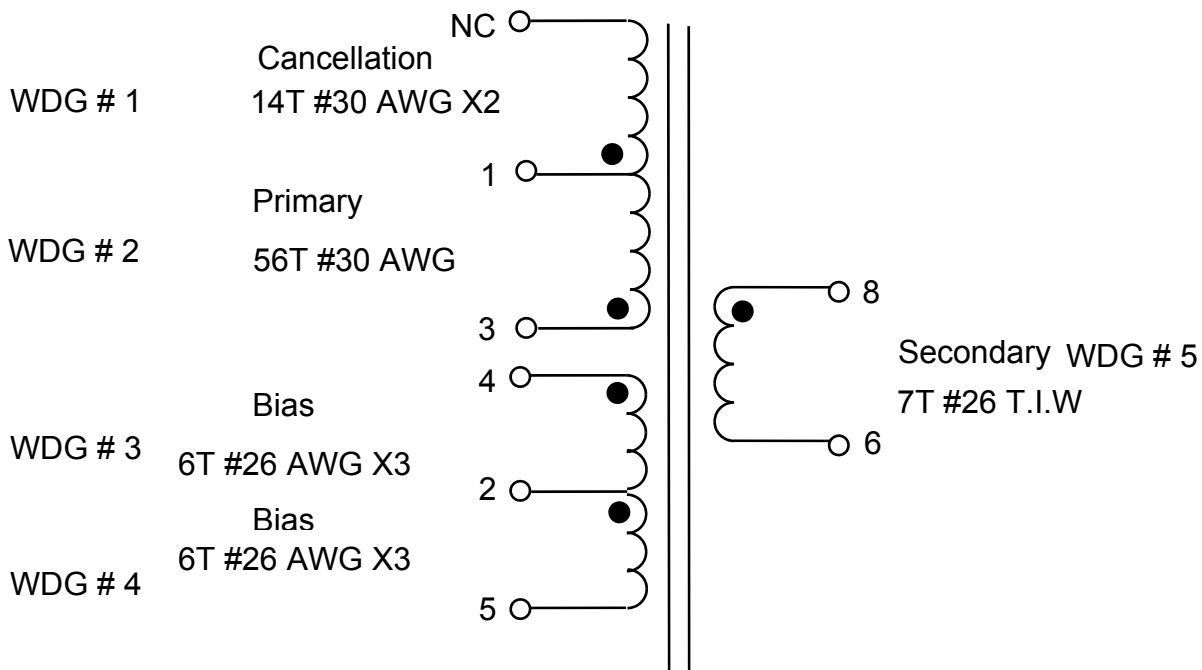

Figure 4 – Transformer Electrical Diagram.

7.2 Electrical Specifications

Electrical Strength	1 second, 60 Hz, from pins 1-5 to pins 6-10.	3000 VAC
Primary Inductance	Pins 1-3, all other windings open, measured at 100 kHz, 0.4 V _{RMS} .	1050 μ H, \pm 10%
Resonant Frequency	Pins 1-3, all other windings open.	500 kHz (Min.)
Primary Leakage Inductance	Pins 1-3, with Pins 6-8 shorted, measured at 100 kHz, 0.4 V _{RMS} .	50 μ H (Max.)

7.3 Materials

Item	Description
[1]	Core: PC40EE25-Z, TDK or equivalent Gapped for A_L of 335 nH/T ² .
[2]	Bobbin: EE25, Vertical, 10 pin – Yih-Hwa part # YW-360-02B.
[3]	Magnet Wire: #30 AWG.
[4]	Magnet Wire: #26 AWG.
[5]	Triple Insulated Wire: #26 AWG
[6]	Tape: 3M # 44 Polyester web. 2.0 mm wide..
[7]	Tape: 3M 1298 Polyester Film, 2.0 mils thick, 8.6 mm wide.
[8]	Tape: 3M 1298 Polyester Film, 2.0 mils thick, 10.7 mm wide..
[9]	Tape: 3M 1298 Polyester Film, 2.0 mils thick, 4.0 mm wide.
[10]	Varnish (applied by dipping only, not vacuum impregnation).



7.4 Transformer Build Diagram

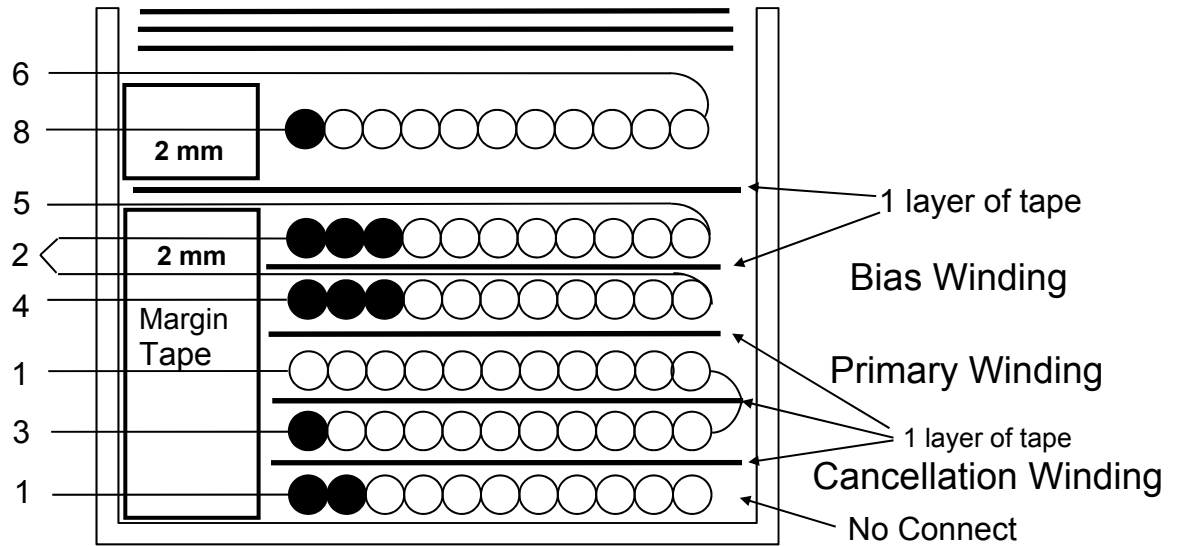

Figure 5 – Transformer Build Diagram.

7.5 Transformer Construction

Bobbin Set Up Orientation	Set up the bobbin with its pins oriented to the left hand side.
Margin Tape	Apply 2.0 mm margin at the pin side of bobbin using item [6]. Match combined height of shield, primary, and bias windings.
WD1 Cancellation Winding	Start at pin 1. Wind 14 bifilar turns of item [3] from left to right. Wind with tight tension across entire bobbin evenly. Cut the ends of the bifilar and leave floating.
Insulation	1 layer of tape [7] for insulation.
WD#2 Primary winding	Start at pin 3. Wind 28 turns of item [3] from left to right. Apply 1 layer of tape [7] for insulation. Wind another 28 turns from right to left. Wind with tight tension across entire bobbin evenly. Finish at pin 1.
Insulation	1 layer of tape [7] for insulation.
WD #3 Bias Winding	Start at Pin 4, wind 6 trifilar turns of item [5]. Wind from left to right with tight tension. Wind uniformly, in a single layer across entire width of bobbin. Finish on pin 2.
Insulation	1 layer of tape [7] for insulation.
WD #4 Bias Winding	Start at pin 2, wind 6 trifilar turns of item [5] from left to right with tight tension. Wind uniformly, in a single layer across entire width of bobbin. Finish on pin 5.
Insulation	1 layer of tape [8] for insulation.
Margin Tape	Apply 2.0 mm margin at the pin side of bobbin using item [6]. Match combined height of secondary windings.
WD #5 Secondary Winding	Start at pin 8, wind 7 turns of item [5] from left to right. Wind uniformly, in a single layer across entire bobbin evenly. Finish on pin 6.
Outer Insulation	3 layers of tape [8] for insulation.
Core Assembly	Assemble and secure core halves using item [1] and item [9].
Varnish	Dip varnish using item [10] (do not vacuum impregnate).



8 Transformer Design Spreadsheet

ACDC_TinySwitch-III_011906; Rev.0.27; Copyright Power Integrations 2006	INPUT	INFO	OUTPUT	UNIT	ACDC_TinySwitch-III_011906_Rev0-27.xls; TinySwitch-III Continuous/Discontinuous Flyback Transformer Design Spreadsheet
ENTER APPLICATION VARIABLES					RD-91 - 12 V, 1 A, Universal Input
VACMIN	85			Volts	Minimum AC Input Voltage
VACMAX	265			Volts	Maximum AC Input Voltage
fL	50			Hertz	AC Mains Frequency
VO	12.00			Volts	Output Voltage (at continuous power)
IO	1.00			Amps	Power Supply Output Current (corresponding to peak power)
Power			12	Watts	Continuous Output Power
n	0.71				Efficiency Estimate at output terminals. Enter 0.7 if no better data available
Z	0.50				Z Factor. Ratio of secondary side losses to the total losses in the power supply. Use 0.5 if no better data available
tC	3.00			mSeconds	Bridge Rectifier Conduction Time Estimate
CIN	28.80		28.8	uFarads	Input Capacitance
ENTER TinySwitch-III VARIABLES					
TinySwitch-III	TNY278		TNY278		User defined TinySwitch-III
Chosen Device		TNY278			
Chose Configuration	STD		Standard Current Limit		Enter "RED" for reduced current limit (sealed adapters), "STD" for standard current limit or "INC" for increased current limit (peak or higher power applications)
ILIMITMIN			0.512	Amps	Minimum Current Limit
ILIMITTYP			0.550	Amps	
ILIMITMAX			0.588	Amps	Maximum Current Limit
fSmin			124000	Hertz	Minimum Device Switching Frequency
I ² fmin			35.937	A ² kHz	I ² f (product of current limit squared and frequency is trimmed for tighter tolerance)
VOR	101.00		101	Volts	Reflected Output Voltage (VOR < 135 V Recommended)
VDS			10	Volts	TinySwitch-III on-state Drain to Source Voltage
VD			0.7	Volts	Output Winding Diode Forward Voltage Drop
KP			0.60		Ripple to Peak Current Ratio (KP < 6)
KP_TRANSIENT			0.38		Transient Ripple to Peak Current Ratio. Ensure KP_TRANSIENT > 0.25
ENTER BIAS WINDING VARIABLES					
VB			22.00	Volts	Bias Winding Voltage
NB			12.13		Bias Winding Number of Turns
VZOV			28.00	Volts	Over Voltage Protection zener diode.
UVLO VARIABLES					
V_UV_TARGET	92		92.00	Volts	Target under-voltage threshold, above which the power supply with start
V_UV_ACTUAL			92.20	Volts	Typical start-up voltage based on standard value of RUV_ACTUAL
RUV_IDEAL			3.59	Mohms	Calculated value for UV Lockout resistor
RUV_ACTUAL			3.60	Mohms	Closest standard value of resistor to RUV_IDEAL
ENTER TRANSFORMER CORE/CONSTRUCTION VARIABLES					
Core Type	EE25		EE25		User-Selected transformer core
Core		EE25		P/N:	PC40EE25-Z
Bobbin		EE25 BOBBIN		P/N:	EE25 BOBBIN
AE			0.404	cm ²	Core Effective Cross Sectional Area
LE			7.34	cm	Core Effective Path Length
AL			1420	nH/T ²	Ungapped Core Effective Inductance
BW			10.2	mm	Bobbin Physical Winding Width
M	1.00		1	mm	Safety Margin Width (Half the Primary to Secondary Creepage Distance)



L	2.00		2		Number of Primary Layers
NS	7		7		Number of Secondary Turns
DC INPUT VOLTAGE PARAMETERS					
VMIN			79	Volts	Minimum DC Input Voltage
VMAX			375	Volts	Maximum DC Input Voltage
CURRENT WAVEFORM SHAPE PARAMETERS					
DMAX			0.59		Duty Ratio at full load, minimum primary inductance and minimum input voltage
I AVG			0.24	Amps	Average Primary Current
IP			0.5120	Amps	Minimum Peak Primary Current
IR			0.3075	Amps	Primary Ripple Current
IRMS			0.33	Amps	Primary RMS Current
TRANSFORMER PRIMARY DESIGN PARAMETERS					
LP			1050	uHenries	Typical Primary Inductance. +/- 10% to ensure a minimum primary inductance of 954 uH
LP_TOLERANCE	10.00		10	%	Primary inductance tolerance
NP			56		Primary Winding Number of Turns
ALG			339	nH/T^2	Gapped Core Effective Inductance
BM			2745	Gauss	Maximum Operating Flux Density, BM<3000 is recommended
BAC			824	Gauss	AC Flux Density for Core Loss Curves (0.5 X Peak to Peak)
ur			2053		Relative Permeability of Ungapped Core
LG			0.11	mm	Gap Length (Lg > 0.1 mm)
BWE			16.4	mm	Effective Bobbin Width
OD			0.295	mm	Maximum Primary Wire Diameter including insulation
INS			0.05	mm	Estimated Total Insulation Thickness (= 2 * film thickness)
DIA			0.243	mm	Bare conductor diameter
AWG			31	AWG	Primary Wire Gauge (Rounded to next smaller standard AWG value)
CM			81	Cmils	Bare conductor effective area in circular mils
CMA			247	Cmils/Amp	Primary Winding Current Capacity (200 < CMA < 500)
TRANSFORMER SECONDARY DESIGN PARAMETERS					
Lumped parameters					
ISP			4.07	Amps	Peak Secondary Current
ISRMS			2.15	Amps	Secondary RMS Current
IRIPPLE			1.90	Amps	Output Capacitor RMS Ripple Current
CMS			430	Cmils	Secondary Bare Conductor minimum circular mils
AWGS			23	AWG	Secondary Wire Gauge (Rounded up to next larger standard AWG value)
VOLTAGE STRESS PARAMETERS					
VDRAIN			607	Volts	Maximum Drain Voltage Estimate (Assumes 20% zener clamp tolerance and an additional 10% temperature tolerance)
PIVS			59	Volts	Output Rectifier Maximum Peak Inverse Voltage



9 Performance Data

The ON/OFF control scheme employed by TinySwitch-III yields virtually constant efficiency across the 25% to 100% load range required for compliance with EPA, CEC, CECP and AGO energy efficiency standards for external power supplies (EPS). Even at loads below 10% of the supply’s full rated output power, efficiency remains above 65%, providing excellent standby performance for applications that require it. This performance is automatic with ON/OFF control. There are no special burst modes that require the designer to consider specific thresholds within the load range in order to achieve compliance with global energy efficiency standards.

All measurements performed at room temperature, 60 Hz input frequency.

9.1 Efficiency

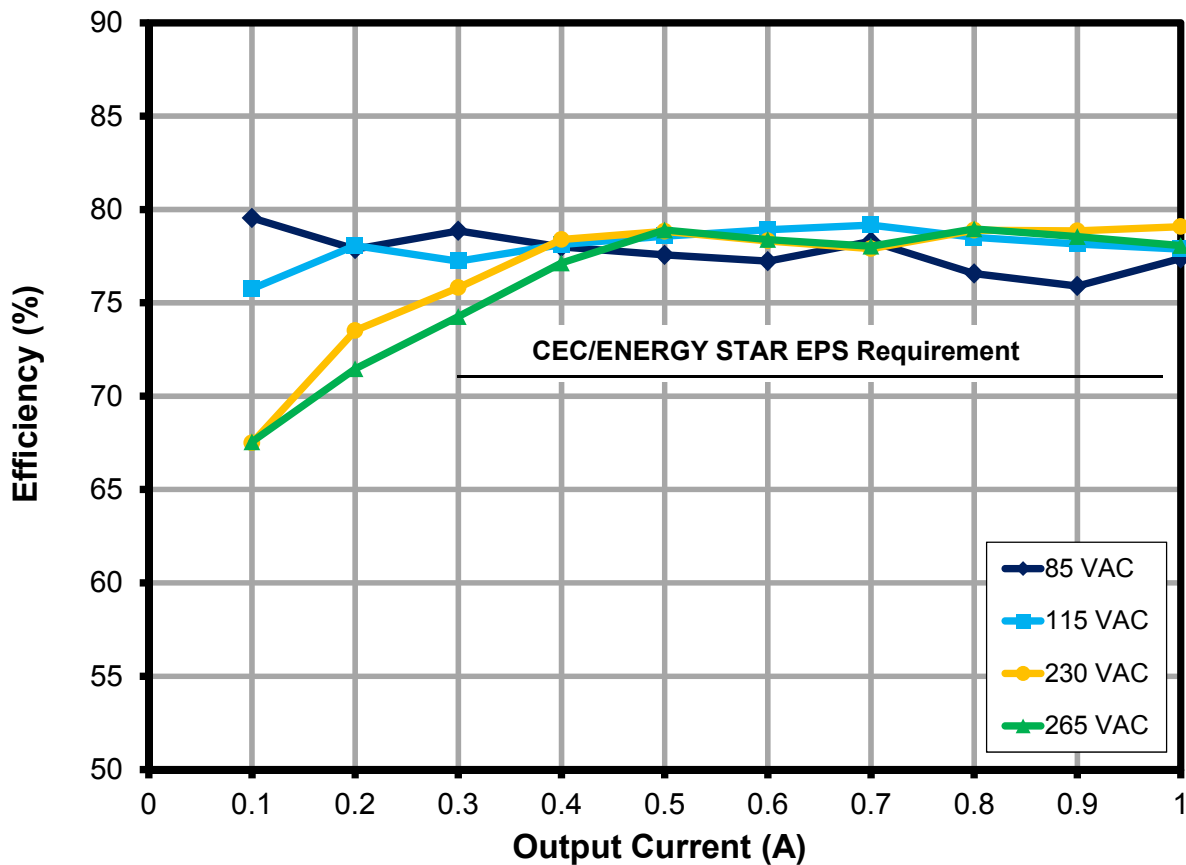

Figure 6 – Efficiency vs. Output Current, Room Temperature, 60 Hz.



9.2 Active Mode CEC Measurement Data

In the state of California, after July 1, 2006, all single-output EPS adapters – including those sold with the products they power – must meet the California Energy Commission (CEC) requirement for minimum active-mode efficiency and no-load input power consumption. Minimum active-mode efficiency is defined as the average efficiency at 25, 50, 75 and 100% of rated output power printed on the nameplate of the supply:

Nameplate Output (P_o)	Minimum Efficiency in Active Mode of Operation
< 1 W	$0.49 \times P_o$
≥ 1 W to ≤ 49 W	$0.09 \times \ln(P_o) + 0.49$ [ln = natural log]
> 49 W	0.84 W

For adapters that are single input voltage only, the measurements are to be made at the nominal rated input voltage (115 VAC or 230 VAC). For universal input adapters, the measurements are to be made at both nominal input voltages (115 VAC and 230 VAC).

To comply with the standard, the average of the four efficiency measurements must be greater than or equal to the efficiency specified by the standard.

Percent of Full Load	Efficiency (%)	
	115 VAC	230 VAC
25	75	74.5
50	78.5	78.8
75	78.8	78.5
100	78	79.1
Average	77.6	77.7
Required CEC minimum average efficiency (%)	71.3	

From these results it is apparent that the efficiency of this design easily exceeds the required 71.3 %. More states within the USA, and many other countries around the world are adopting similar energy efficiency standards (based on the original Energy Star standard). For the latest, up-to-date information on energy efficiency regulations, please visit the PI Green Room, at:

<http://www.powerint.com/greenroom/regulations.htm>



9.3 No-load Input Power (R8 not installed: no bias winding supplementation)

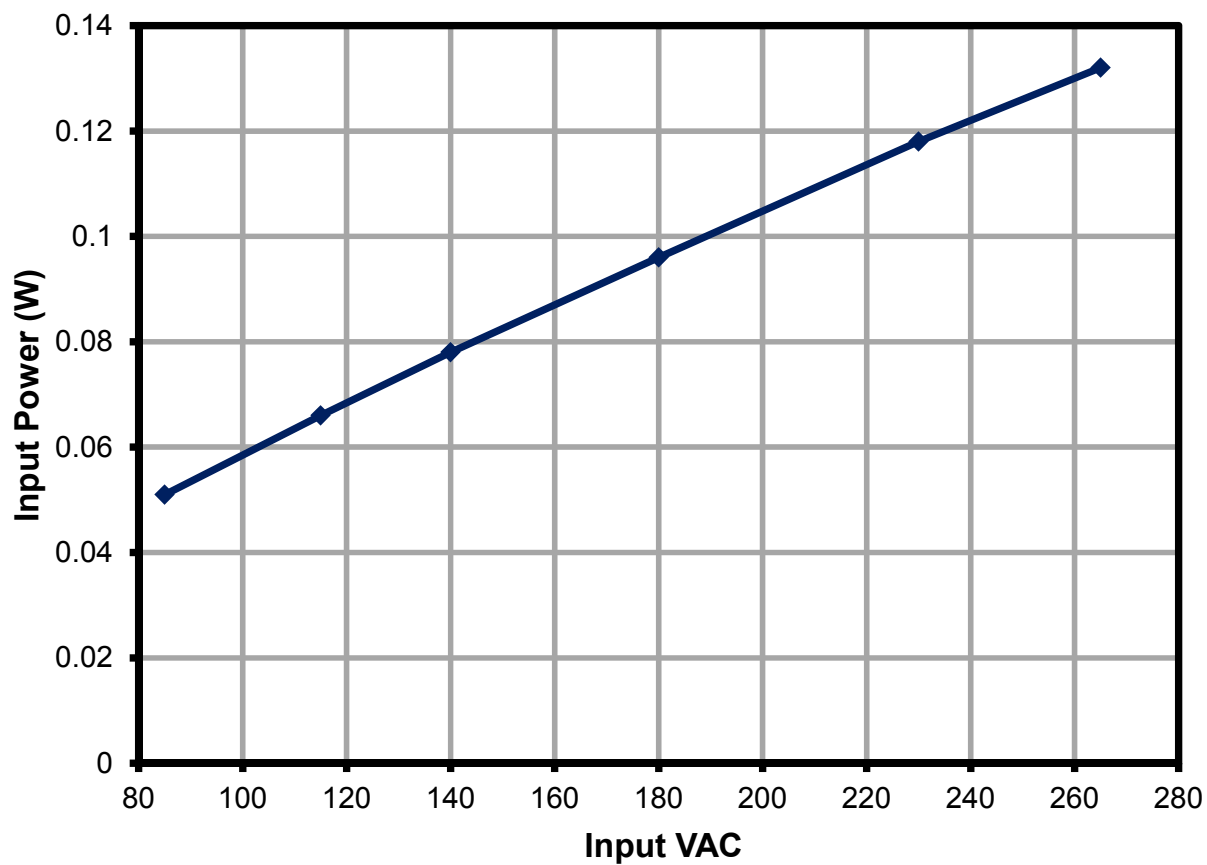

Figure 7 – No-load Input Power vs. Input Line Voltage, Room Temperature, 60 Hz.

9.4 No-load Input Power (with R8 and bias winding supplementation)

Figure 8 – No-load Input Power vs. Input Line Voltage, Room Temperature, 60 Hz, with Bias Winding.



9.5 Available Standby Output Power

The chart below shows the available output power versus line voltage at input power consumption levels of 1, 2 and 3 watts (respectively). Again, this performance illustrates the value of ON/OFF control, as it automatically maintains a high efficiency, even during very light loading. This simplifies complying with standby requirements that specify that a fair amount of power be available to the load at low input power consumption levels. The *TinySwitch-III* ON/OFF control scheme maximizes the amount of output power available to the load in standby operation when the allowable input power is fixed at a low value. This simplifies the design of products such as printers, set-top boxes, DVD players, etc. that must meet stringent standby power consumption requirements.

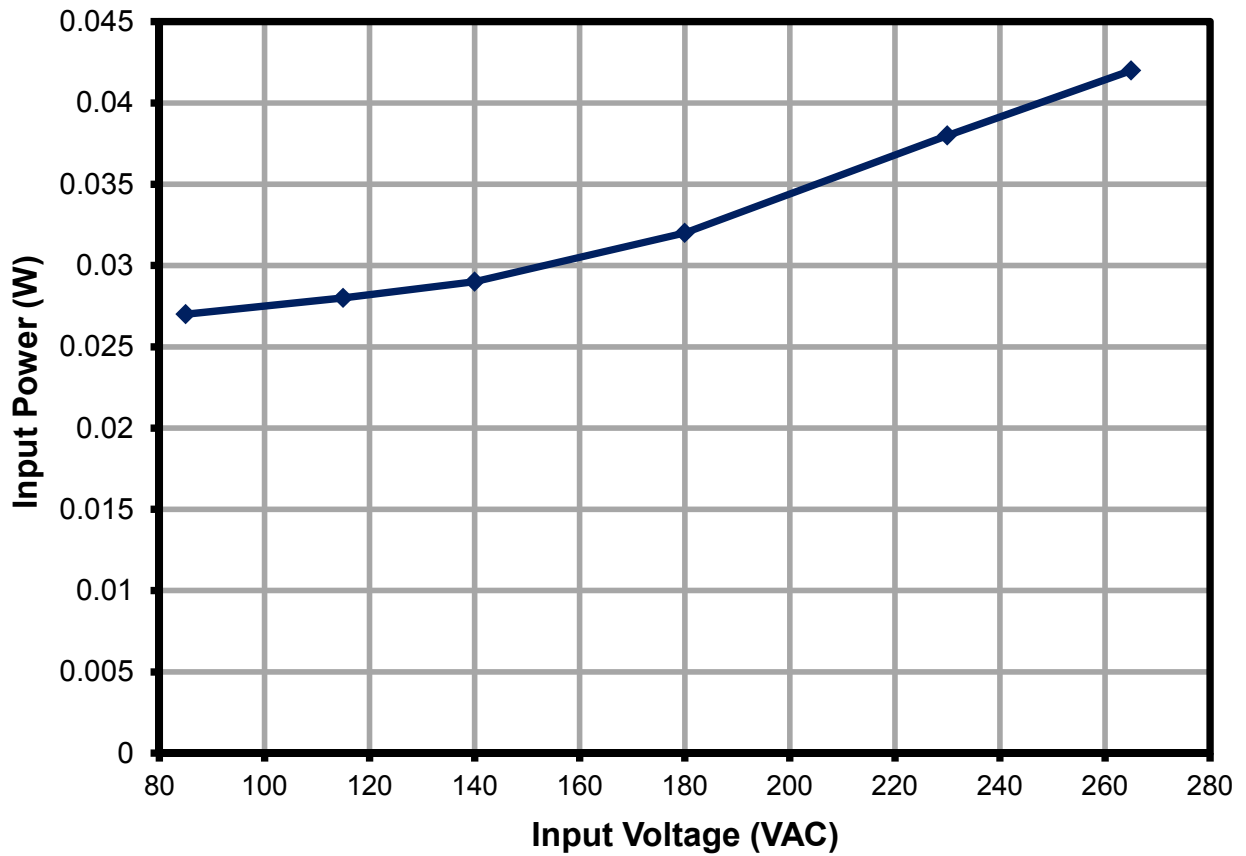
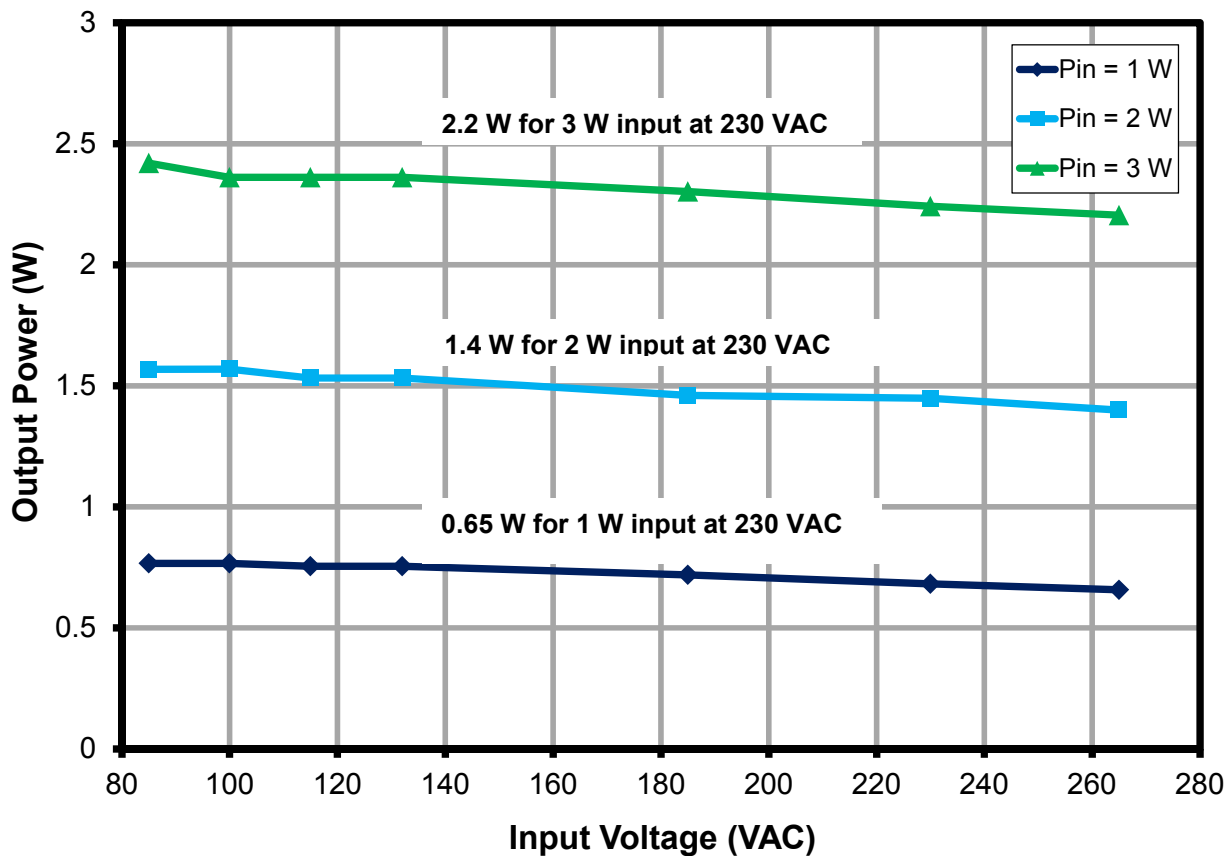

Figure 9 – Available Output Power for 1, 2 and 3 Watts of Input Power.



9.6 Regulation

9.6.1 Load and Line

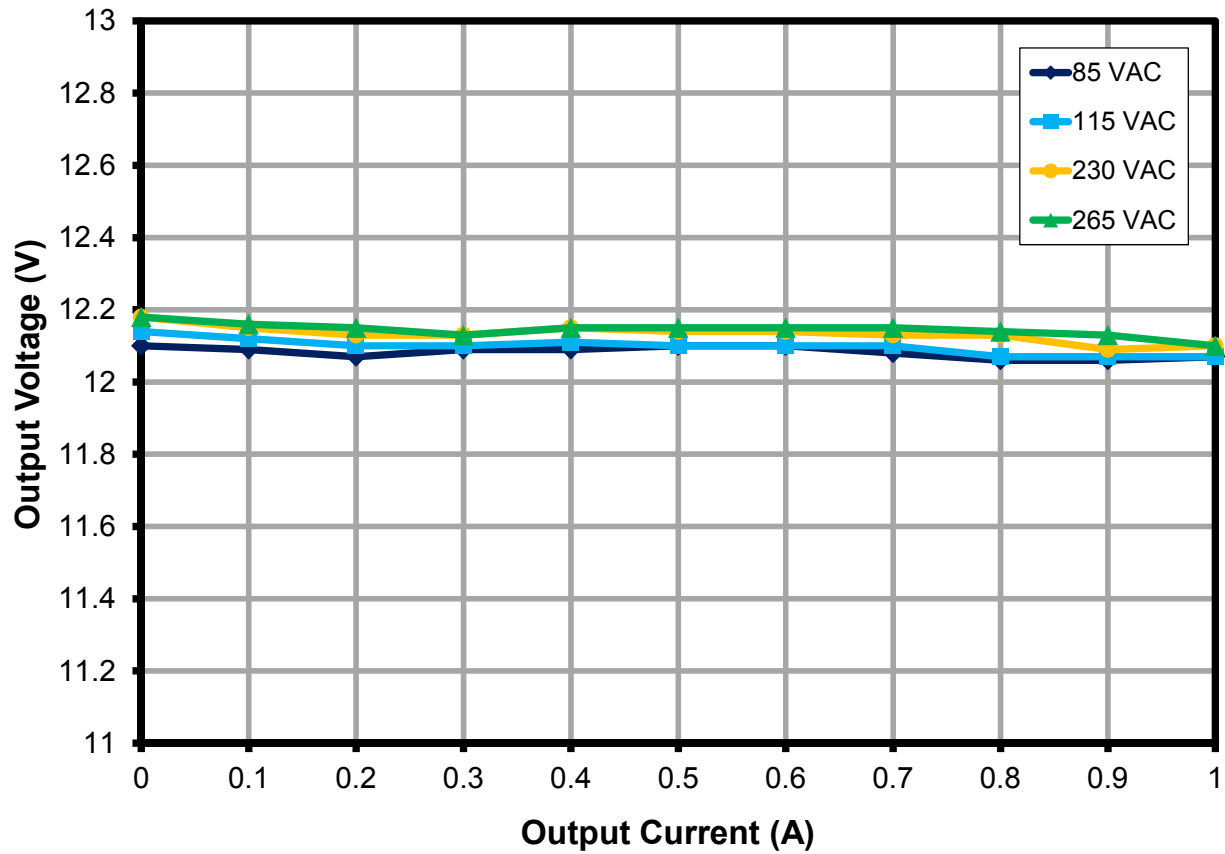

Figure 10 – Load and Line Regulation, Room Temperature.



10 Thermal Performance

Temperature measurements of key components were taken using T-type thermocouples. The thermocouples were soldered directly to a SOURCE pin of the TNY278PG device and to the cathode of the output rectifier. The thermocouples were glued to the output capacitor and to the external core and winding surfaces of transformer T1.

The unit was sealed inside a large box to eliminate any air currents. The box was placed inside a thermal chamber. The ambient temperature within the large box was raised to 50 °C. The unit was then operated at full load and the temperature measurements were taken after they stabilized for 1 hour at 50 °C.

Temperature (°C)		
Item	85 VAC	265 VAC
Ambient	50*	50*
TNY278PG (U1)	96.1	92.8
Transformer (T1)	77.8	80
Output Rectifier (D7)	101	100
Output Capacitor (C10)	68.2	66.8

*To simulate operation inside sealed enclosure at 40 °C external ambient.

These results show that all key components have an acceptable rise in temperature.

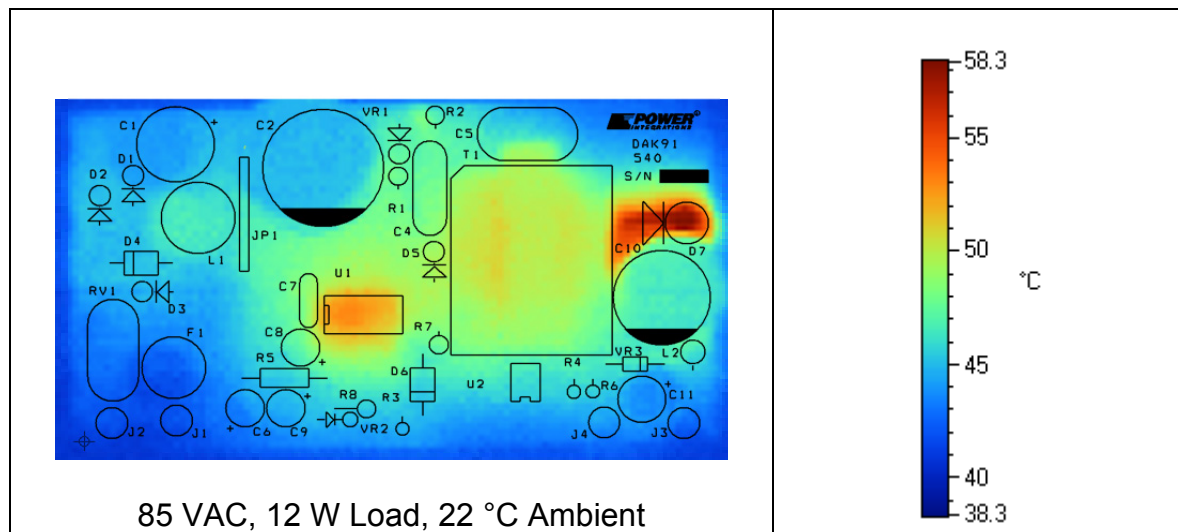

Figure 11 – Infrared Thermograph of Open Frame Operation, at Room Temperature.

11 Waveforms

11.1 Drain Voltage and Current, Normal Operation

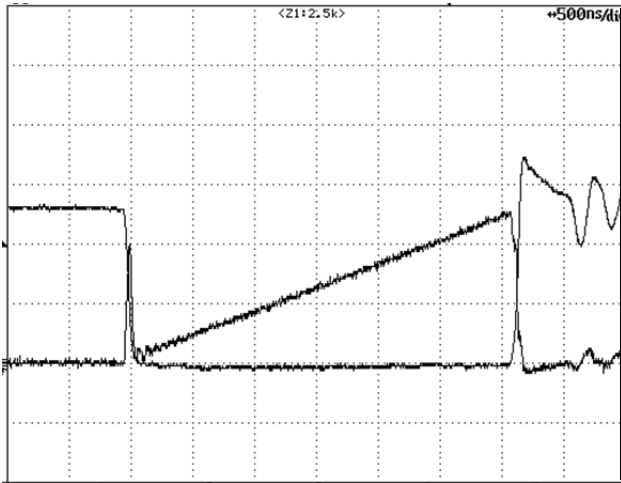

Figure 12 – 115 VAC, Full Load.
Upper: I_{DRAIN} , 0.2 A / div.
Lower: V_{DRAIN} , 50 V, 500 ns / div.

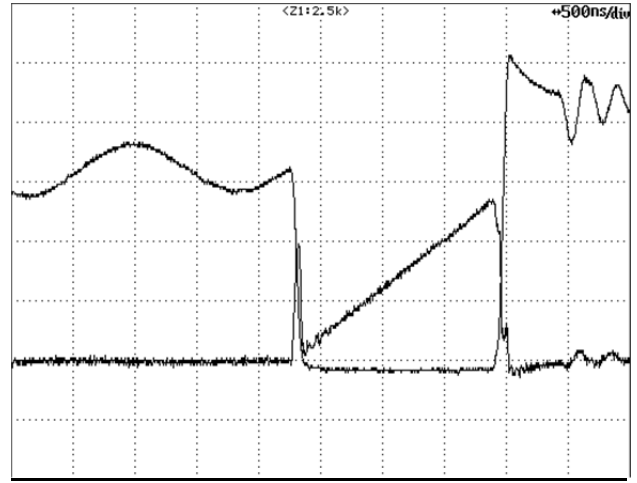

Figure 13 – 230 VAC, Full Load.
Upper: I_{DRAIN} , 0.2 A / div.
Lower: V_{DRAIN} , 100 V / div.

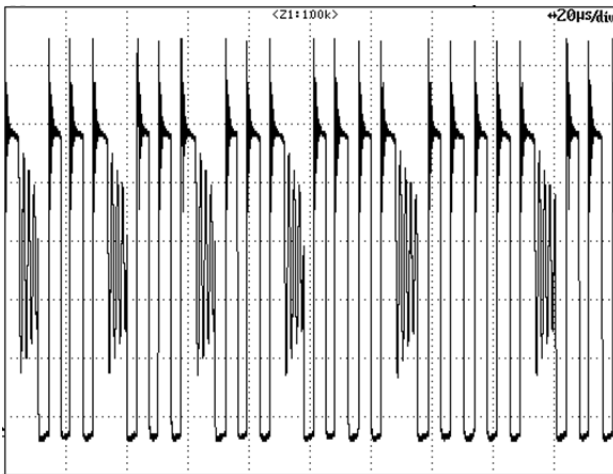

Figure 14 – 115 VAC, Full Load.
 V_{DRAIN} , 50 V, 20 μ s / div.

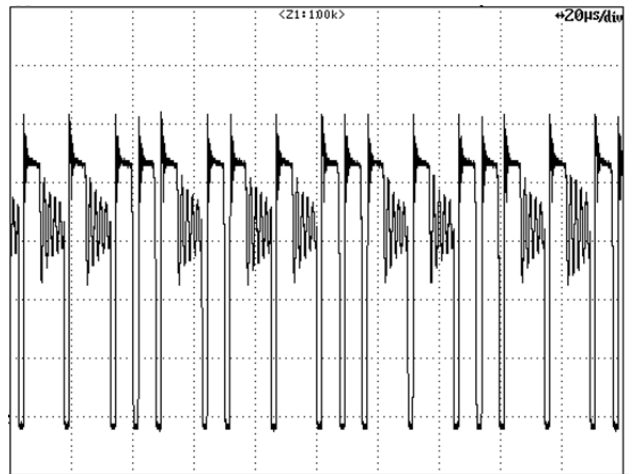

Figure 15 – 230 VAC, Full Load.
 V_{DRAIN} , 100 V, 20 μ s / div.



11.2 Output Voltage Start-Up Profile

Start-up into full resistive load and no-load were both verified. A 12 Ω resistor was used for the load, to maintain 1 A under steady-state conditions.

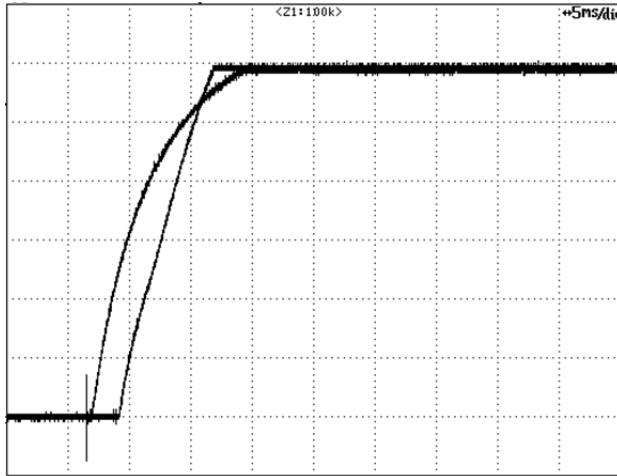

Figure 16 – Start-Up Profile, 115 VAC.
Fast trace is no-load rise time.
Slower trace is maximum load (12 Ω)
2 V, 5 ms / div.



Figure 17 – Start-Up Profile, 230 VAC.
Fast trace is no-load rise time.
Slower trace is maximum load (12 Ω)
2 V, 5 ms / div.

11.3 Drain Voltage and Current Start-Up Profile

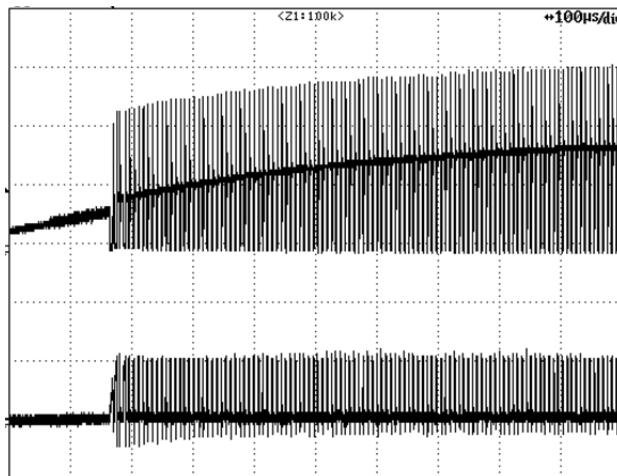

Figure 18 – 90 VAC Input and Maximum Load.
Upper: V_{DRAIN} , 100 V & 100 μ s / div.
Lower: I_{DRAIN} , 0.5 A / div.

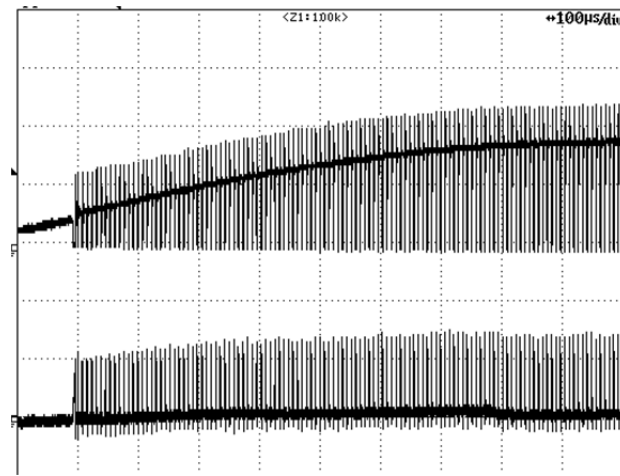

Figure 19 – 265 VAC Input and Maximum Load.
Upper: V_{DRAIN} , 200 V & 100 μ s / div.
Lower: I_{DRAIN} , 0.5 A / div.



11.4 Load Transient Response (75% to 100% Load Step)

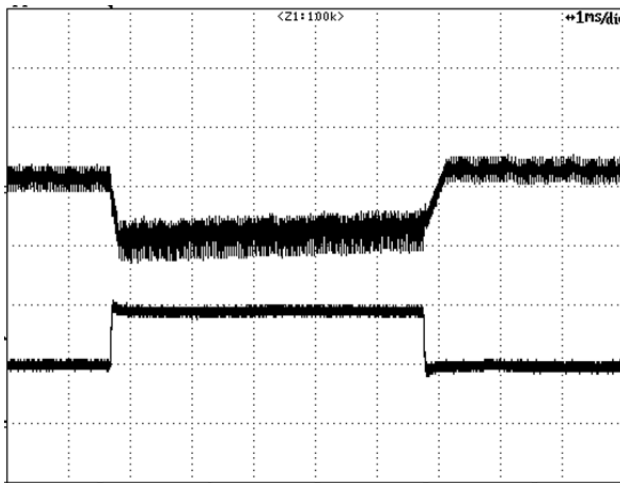

Figure 20 – Transient Response, 115 VAC,
50-100-50% Load Step.
Upper: V_{OUT} 50 mV / div.
Lower: I_{OUT} 0.5 A, 1 ms / div.

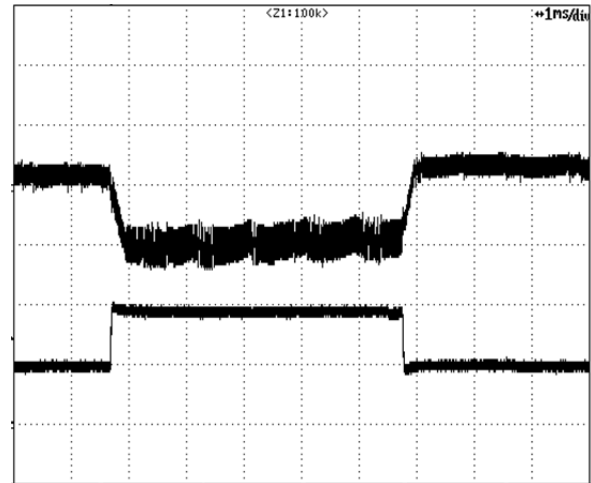

Figure 21 – Transient Response, 230 VAC,
50-100-50% Load Step.
Upper: V_{OUT} 50 mV / div.
Lower: I_{OUT} 0.5 A, 1 ms / div.

11.5 Output Ripple Measurements

11.5.1 Ripple Measurement Technique

A modified oscilloscope test probe was used to take output ripple measurements, in order to reduce the pickup of spurious signals. Using the probe adapter pictured in Figure 22, the output ripple was measured with a 1 μF electrolytic, and a 0.1 μF ceramic capacitor connected as shown.

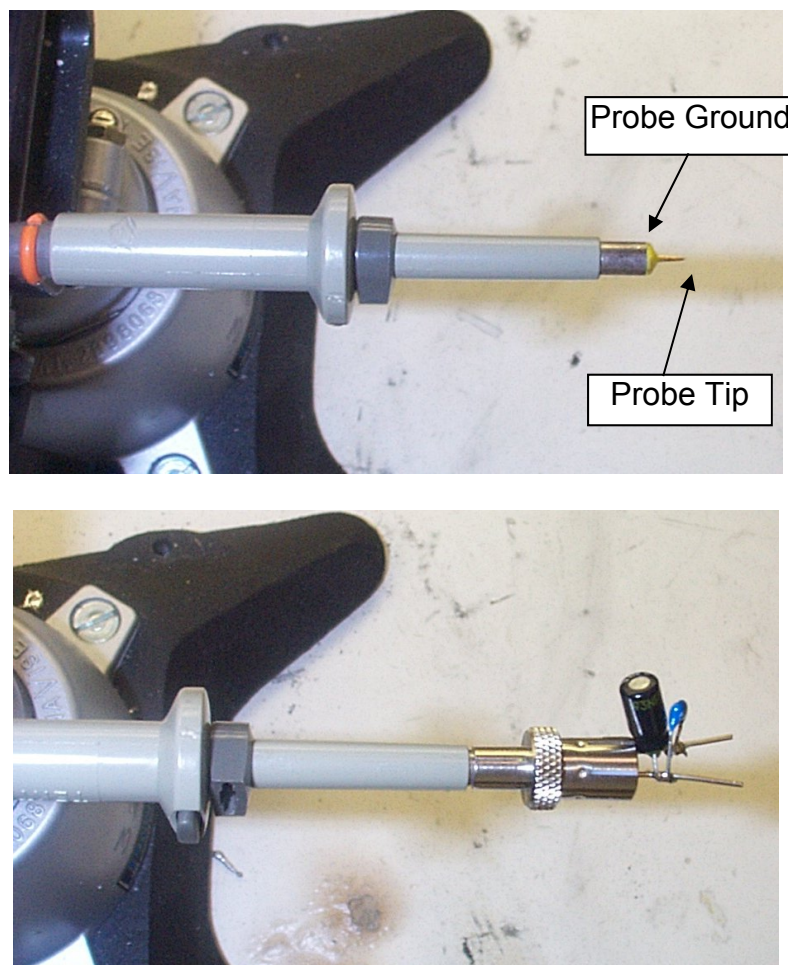

Figure 22 – Oscilloscope Probe Prepared for Ripple Measurement (End Cap and Ground Lead Removed).

11.5.2 Measurement Results

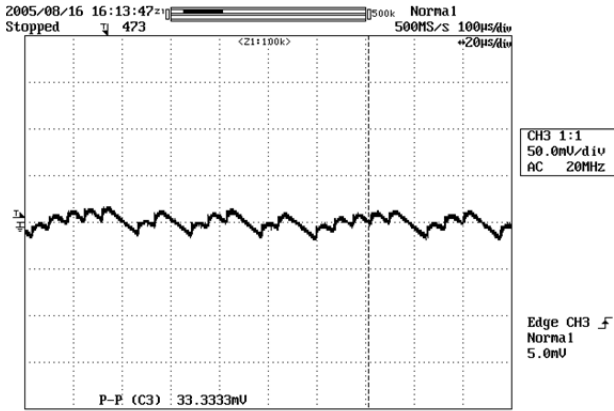

Figure 23 – Ripple, 85 VAC, Full Load.
20 μ s, 50 mV / div.

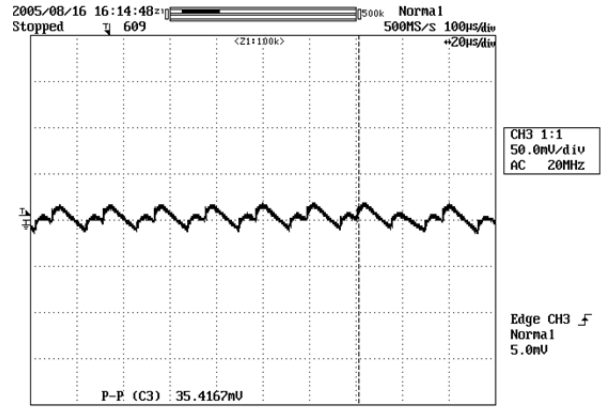

Figure 24 – Ripple, 115 VAC, Full Load.
20 μ s, 50 mV / div.

11.6 Overvoltage Shutdown

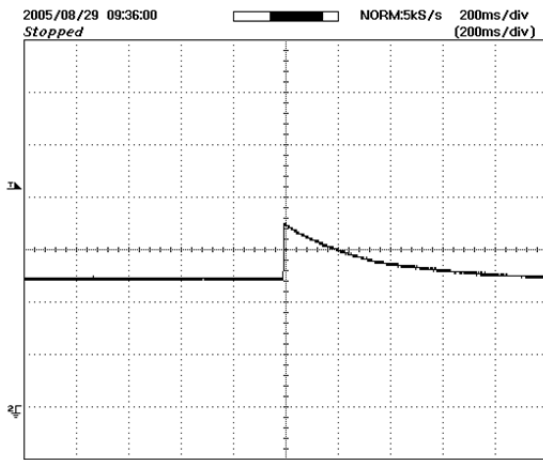

Figure 25 – Overvoltage Shutdown.
265 VAC, No Load.
50 ms, 5 V / div.

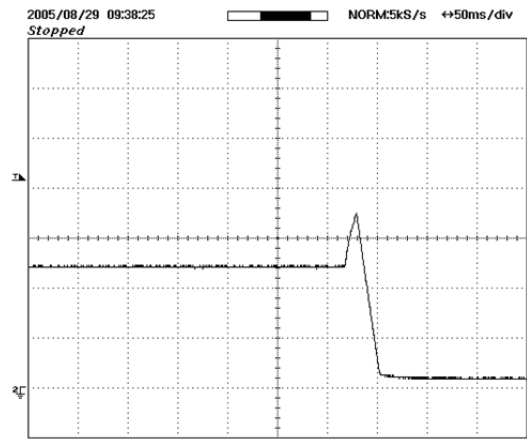

Figure 26 – Overvoltage Shutdown.
265 VAC, Full Load.
50 ms, 5 V / div.



12 Line Surge

Differential input line surge (1.2/50 μ s) testing was completed on a single test unit to IEC61000-4-5. Input voltage was set at 230 VAC / 60 Hz. Output was loaded at full load and operation was verified following each surge event.

Surge Voltage	Phase Angle (°)	Generator Impedance (Ω)	Number of Strikes	Test Result
1 kV Differential	90	2	10	PASS
2 kV Common Mode	90	12	10	PASS

Unit passed under all test conditions.



13 Conducted EMI

Conducted emissions tests were performed at 115 VAC and 230 VAC at full load (12 V, 1 A). Measurements were taken with an Artificial Hand connected and a floating DC output load resistor. A DC output cable was included.

Composite EN55022B / CISPR22B conducted limits are shown. In all cases there was excellent (>10 dB) margin.

13.1 115 VAC, Full Load

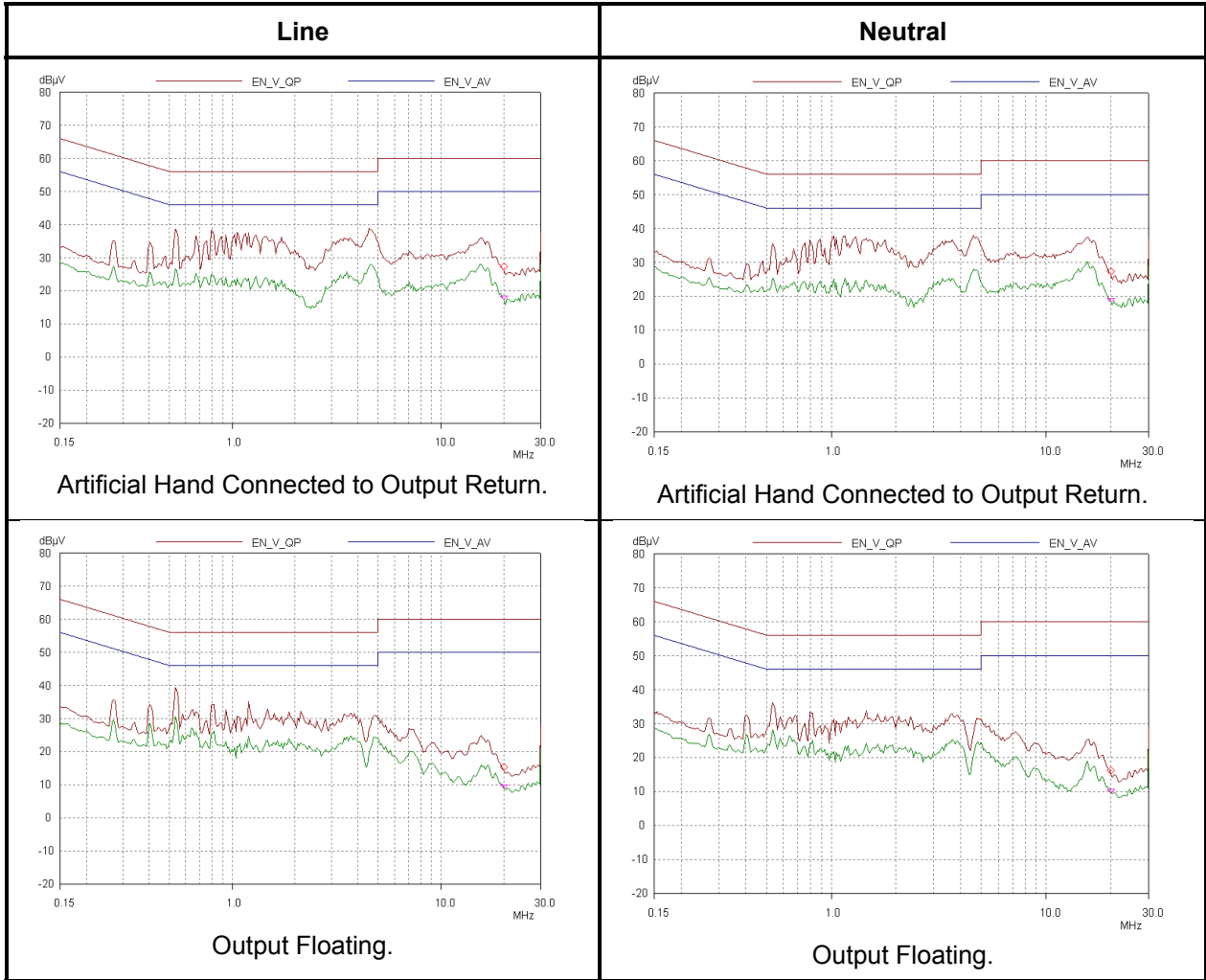

Figure 27 – Conducted EMI at 115 VAC.



13.2 230 VAC, Full Load

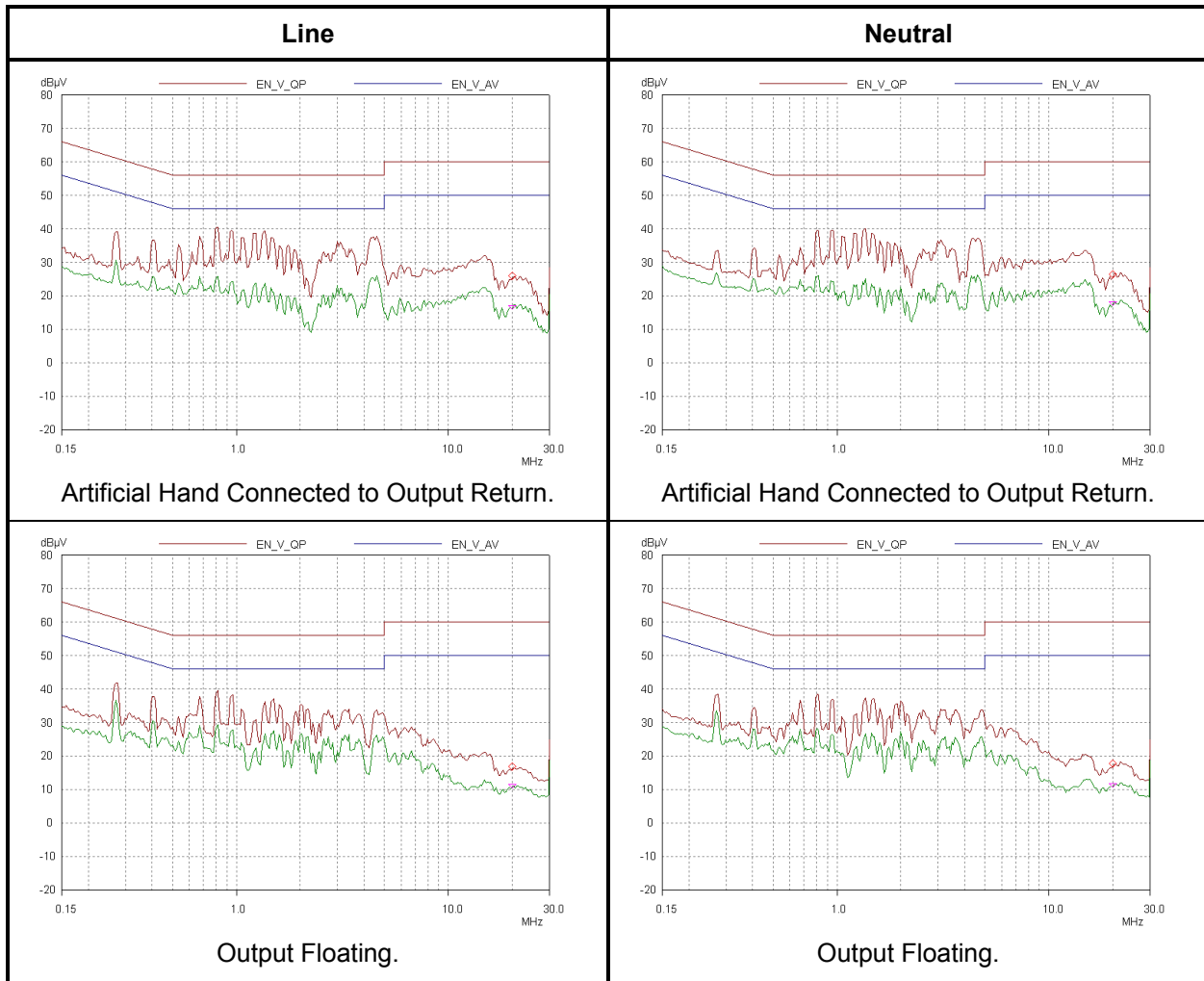

Figure 28 – Conducted EMI at 230 VAC.



14 Audible Noise

An open-frame (no enclosure) unit was tested with an Audio Precision Analyzer, using a microphone positioned one inch from the core of transformer T1. The test was done with the unit in an acoustically isolated and dampened chamber. The load was adjusted until a maximum reading was obtained.

35 dBrA is considered the acceptable limit for frequencies below 18 kHz. An enclosure will typically further reduce measurable acoustic noise levels by an additional 10 dBrA.

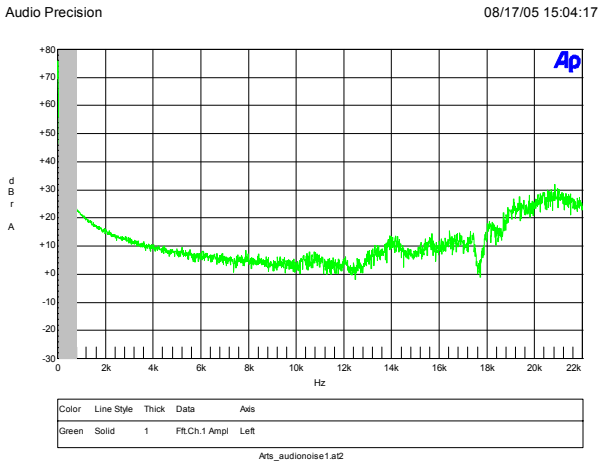

Figure 29 – Audible Noise $V_{IN} = 120$ VAC;
 $I_{OUT} = 350$ mA.

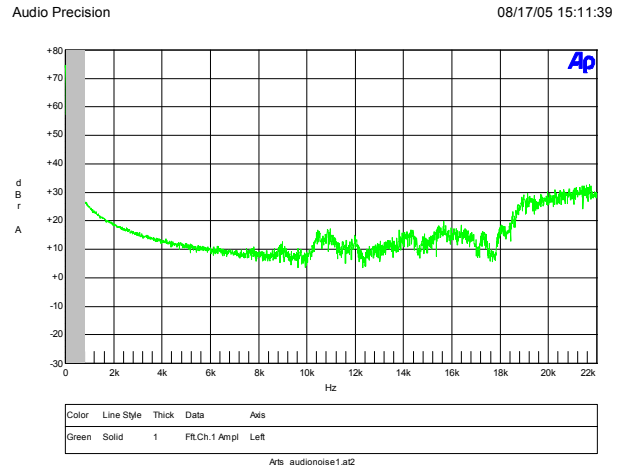

Figure 30 – Audible Noise $V_{IN} = 120$ VAC;
 $I_{OUT} = 1$ A.

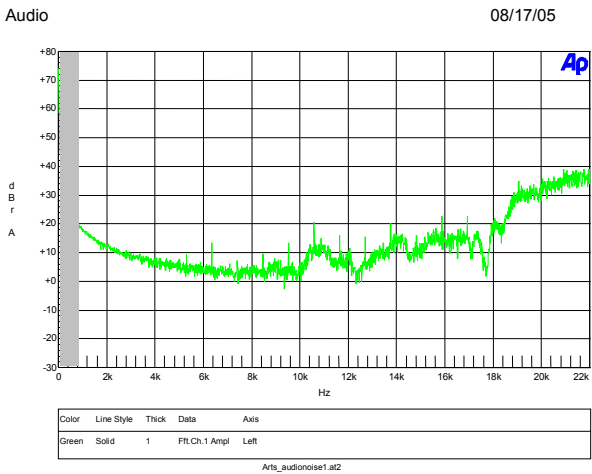

Figure 31 – Audible Noise $V_{IN} = 230$ VAC;
 $I_{OUT} = 1$ A.



Figure 32 – Audible Noise $V_{IN} = 230$ VAC;
 $I_{OUT} = 1.2$ A.

Note: Shaded area obscured due to ambient noise.



15 Extended and Reduced Current Limit (I_{LIMIT}) Operation

Capacitors (C8 and C9 on the BOM in Section 6) can be added to the board to try out the $I_{LIMIT+1}$ and $I_{LIMIT-1}$ operation of TNY278PG. When C7 (0.1 μ F) is replaced with a 10 μ F capacitor (C9), the TNY278PG will operate in the $I_{LIMIT+1}$ mode, which increases the maximum primary current limit from the standard maximum limit of 0.55 A to 0.65 A (equal to that of a TNY279PG). This allows a TNY278PG to deliver from 15% to 25% more output power (depending on the output voltage and current).

CAUTION: Because RD-91 was designed for standard I_{LIMIT} operation, It should not be loaded with more than 1.25 A at an elevated temperature for very long (a few minutes) when verifying the performance of TNY278PG in the $I_{LIMIT+1}$ mode, since the other power components (transformer, input bulk capacitors, output diode, output capacitors and primary clamp network) are not sized for sustained operation at more than 12 W.

When C7 is replaced with a 1 μ F capacitor (C8), the TNY278PG will operate in the $I_{LIMIT-1}$ mode, which reduces the maximum current limit from the standard maximum limit of 0.55 A to 0.45 A (equal to that of a TNY277PG). Although this reduces the maximum output power that the supply can deliver, it typically will increase the efficiency, especially at lower output power levels. To take the fullest advantage of the increase in efficiency that can be obtained from $I_{LIMIT-1}$ operation, the power transformer would need to be redesigned slightly.

16 TNY277PG and TNY279PG Operation in RD-91

A TNY277PG device used in the $I_{LIMIT+1}$ mode (a 10 μ F installed in place of C7) will work in the RD-91 reference board, and deliver output power equal to that of a TNY278PG device. This flexibility allows a design engineer the option of using a lower cost part in applications with less demanding thermal requirements.

A TNY279PG device used in the $I_{LIMIT-1}$ mode (a 1 μ F installed in place of C7) will deliver the same output power as a TNY278PG in the standard I_{LIMIT} configuration. This can improve efficiency and lower the temperature rise of the device, which can give greater thermal margin to a design that must operate in high ambient temperature environments.



17 OVP Operation Verification

While the RD-91 is in normal operation, monitor the output with a storage oscilloscope. To cause an overvoltage condition to occur, short-circuit the optocoupler LED (as shown below) to open the feedback control loop. The oscilloscope will capture the output voltage rising until the increasing voltage across VR2 causes it to conduct, and the TNY278PG device latches off. To reset the OVP latch, the AC input power must be removed long enough to allow the input bulk capacitors to fully discharge.

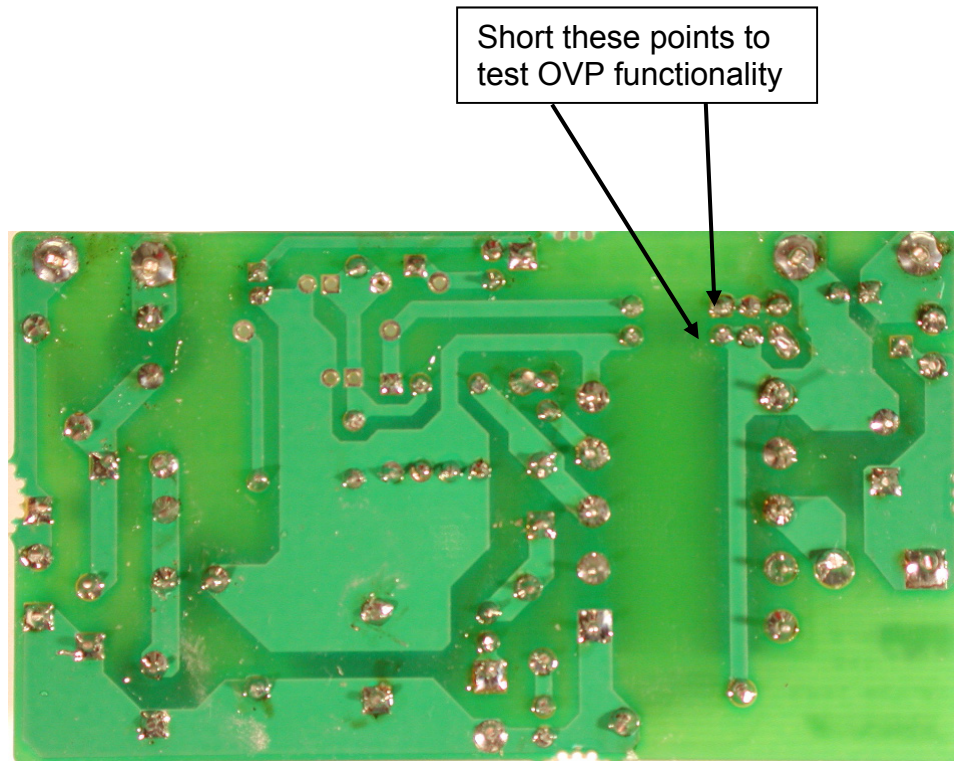

Figure 33 – Point on PCB to Apply Short-Circuit to Trigger OV Shutdown.

18 Revision History

Date	Author	Revision	Description an Changes	Approved
25-Jan-06	JAJ	1.0	Formatted for Final Release	
07-Feb-06	JAJ	1.1	Formatted and corrected measurement scales / div.	
18-Jul-07	SGK	1.2	Updated for RoHS compliance, changed to RD-91.	
21-Nov-11	KM	1.3	Update style and graphs, fixed BOM, updated PCB.	Apps & Mktg
11-Feb-13	KM	1.4	Updated Figures 11 and 12 Captions.	



For the latest updates, visit our website: www.powerint.com

Power Integrations reserves the right to make changes to its products at any time to improve reliability or manufacturability. Power Integrations does not assume any liability arising from the use of any device or circuit described herein. POWER INTEGRATIONS MAKES NO WARRANTY HEREIN AND SPECIFICALLY DISCLAIMS ALL WARRANTIES INCLUDING, WITHOUT LIMITATION, THE IMPLIED WARRANTIES OF MERCHANTABILITY, FITNESS FOR A PARTICULAR PURPOSE, AND NON-INFRINGEMENT OF THIRD PARTY RIGHTS.

PATENT INFORMATION

The products and applications illustrated herein (including transformer construction and circuits' external to the products) may be covered by one or more U.S. and foreign patents, or potentially by pending U.S. and foreign patent applications assigned to Power Integrations. A complete list of Power Integrations' patents may be found at www.powerint.com. Power Integrations grants its customers a license under certain patent rights as set forth at <http://www.powerint.com/ip.htm>.

The PI Logo, TOPSwitch, TinySwitch, LinkSwitch, LYTSwitch, DPA-Switch, PeakSwitch, CAPZero, SENZero, LinkZero, HiperPFS, HiperTFS, HiperLCS, Qspeed, EcoSmart, Clampless, E-Shield, Filterfuse, StackFET, PI Expert and PI FACTS are trademarks of Power Integrations, Inc. Other trademarks are property of their respective companies. ©Copyright 2013 Power Integrations, Inc.

Power Integrations Worldwide Sales Support Locations

WORLD HEADQUARTERS

5245 Hellyer Avenue
San Jose, CA 95138, USA.
Main: +1-408-414-9200
Customer Service:
Phone: +1-408-414-9665
Fax: +1-408-414-9765
e-mail: usasales@powerint.com

GERMANY

Lindwurmstrasse 114
80337, Munich
Germany
Phone: +49-895-527-39110
Fax: +49-895-527-39200
e-mail: eurosales@powerint.com

JAPAN

Kosei Dai-3 Building
2-12-11, Shin-Yokohama,
Kohoku-ku, Yokohama-shi,
Kanagawa 222-0033
Japan
Phone: +81-45-471-1021
Fax: +81-45-471-3717
e-mail: japansales@powerint.com

TAIWAN

5F, No. 318, Nei Hu Rd.,
Sec. 1
Nei Hu District
Taipei 11493, Taiwan R.O.C.
Phone: +886-2-2659-4570
Fax: +886-2-2659-4550
e-mail: taiwansales@powerint.com

CHINA (SHANGHAI)

Rm 1601/1610, Tower 1,
Kerry Everbright City
No. 218 Tianmu Road West,
Shanghai, P.R.C. 200070
Phone: +86-21-6354-6323
Fax: +86-21-6354-6325
e-mail: chinasales@powerint.com

INDIA

#1, 14th Main Road
Vasanthanagar
Bangalore-560052
India
Phone: +91-80-4113-8020
Fax: +91-80-4113-8023
e-mail: indiasales@powerint.com

KOREA

RM 602, 6FL
Korea City Air Terminal B/D,
159-6
Samsung-Dong, Kangnam-Gu,
Seoul, 135-728 Korea
Phone: +82-2-2016-6610
Fax: +82-2-2016-6630
e-mail: koreasales@powerint.com

EUROPE HQ

1st Floor, St. James's House
East Street, Farnham
Surrey GU9 7TJ
United Kingdom
Phone: +44 (0) 1252-730-141
Fax: +44 (0) 1252-727-689
e-mail: eurosales@powerint.com

CHINA (SHENZHEN)

3rd Floor, Block A,
Zhongtuo International Business
Center, No. 1061, Xiang Mei Rd,
FuTian District, ShenZhen,
China, 518040
Phone: +86-755-8379-3243
Fax: +86-755-8379-5828
e-mail: chinasales@powerint.com

ITALY

Via Milanese 20, 3rd. Fl.
20099 Sesto San Giovanni
(MI) Italy
Phone: +39-024-550-8701
Fax: +39-028-928-6009
e-mail: eurosales@powerint.com

SINGAPORE

51 Newton Road,
#19-01/05 Goldhill Plaza
Singapore, 308900
Phone: +65-6358-2160
Fax: +65-6358-2015
e-mail: singaporesales@powerint.com

APPLICATIONS HOTLINE

World Wide +1-408-414-9660

APPLICATIONS FAX

World Wide +1-408-414-9760

