

**1.0MHz, 2.0A, Synchronous Step Down DC-DC Converter****AP3431**

## General Description

The AP3431 is a high efficiency step-down DC-DC voltage converter. The chip operation is optimized by peak-current mode architecture with built-in synchronous power MOS switchers. The oscillator and timing capacitors are all built-in providing an internal switching frequency of 1MHz that allows the use of small surface mount inductors and capacitors for portable product implementations.

Integrated Soft Start (SS), Under Voltage Lock Out (UVLO), Thermal Shutdown Detection (TSD) and short circuit protection are designed to provide reliable product applications.

The device is available in adjustable output voltage versions ranging from 0.8V to  $0.9 \times V_{IN}$  when input voltage range is from 2.7V to 5.5V, and is able to deliver up to 2.0A.

The AP3431 is available in SOIC-8 package.

## Features

- High Efficiency Buck Power Converter
- Output Current: 2A
- Low  $R_{DS(ON)}$  Internal Switches :  $120m\Omega (V_{IN}=5V)$
- Adjustable Output Voltage from 0.8V to  $0.9 \times V_{IN}$
- Wide Operating Voltage Range: 2.7V to 5.5V
- Built-in Power Switches for Synchronous Rectification with High Efficiency
- Feedback Voltage: 800mV
- Switching Frequency: 1.0MHz
- Thermal Shutdown Protection
- Internal Soft Start

## Applications

- LCD TV
- Set Top Box
- Post DC-DC Voltage Regulation
- PDA and Notebook Computer



Figure 1. Package Type of AP3431

## Pin Configuration

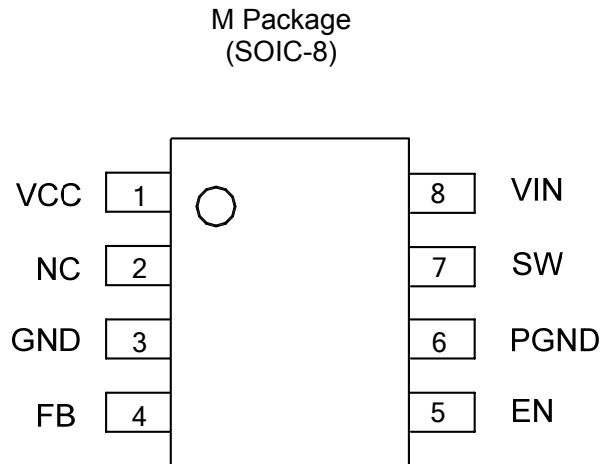

Figure 2. Pin Configuration of AP3431 (Top View)

## Pin Description

Pin Number	Pin Name	Function
1	VCC	Supply input for the analog circuit
2	NC	No connection
3	GND	Ground pin
4	FB	Feedback pin. Receives the feedback voltage from a resistive divider connected across the output
5	EN	Chip enable pin. Active high, internal pull-high with 200kΩ resistor
6	PGND	Power switch ground pin
7	SW	Switch output pin
8	VIN	Power supply input for the MOSFET switch

**1.0MHz, 2.0A, Synchronous Step Down DC-DC Converter**

**AP3431**

**Functional Block Diagram**

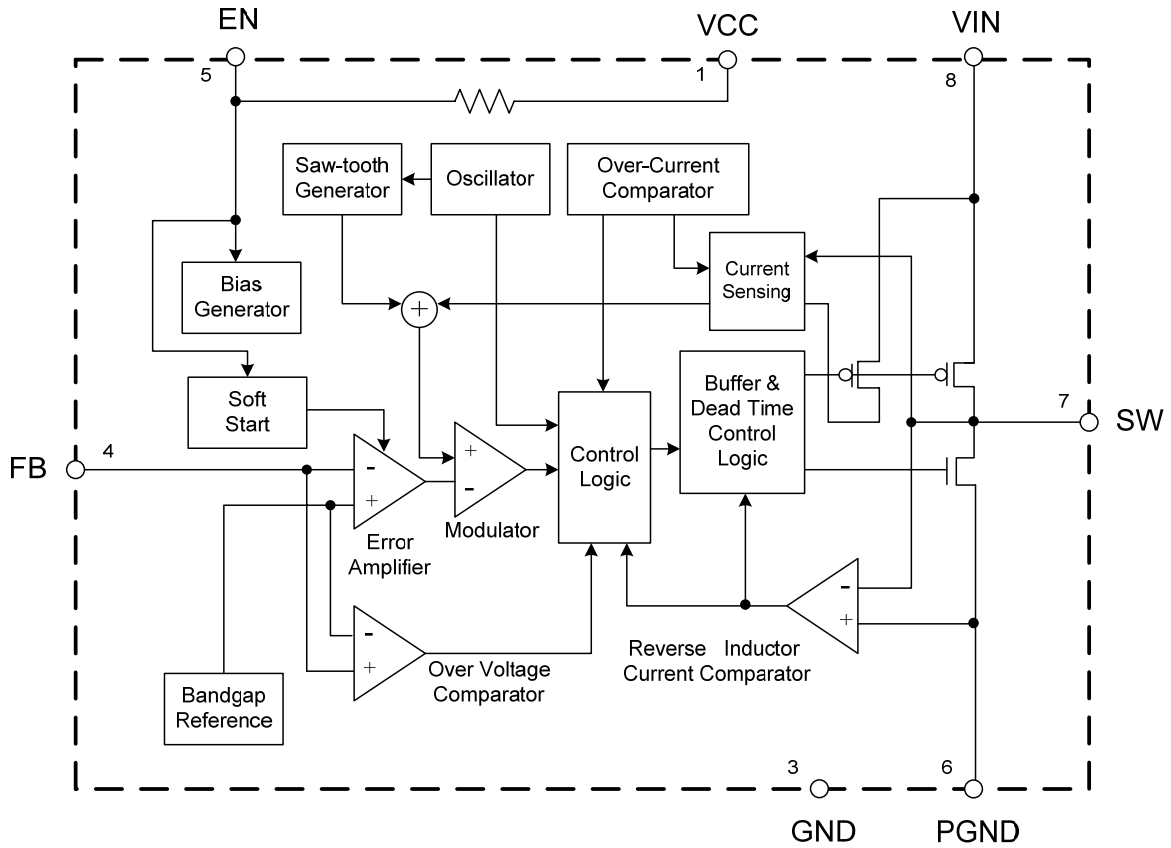
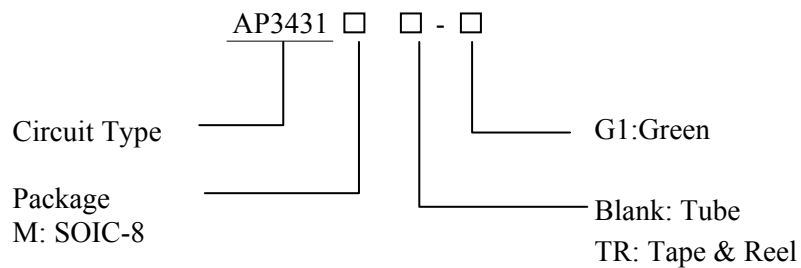

Figure 3. Functional Block Diagram of AP3431

**Ordering Information**



Package	Temperature Range	Part Number	Marking ID	Packing Type
SOIC-8	-40 to 80°C	AP3431M-G1	3431M-G1	Tube
		AP3431MTR-G1	3431M-G1	Tape & Reel

BCD Semiconductor's Pb-free products, as designated with "G1" in the part number, are RoHS compliant and green.

**1.0MHz, 2.0A, Synchronous Step Down DC-DC Converter****AP3431****Absolute Maximum Ratings (Note 1)**

Parameter	Symbol	Value	Unit
Supply Input for the Analog Circuit	$V_{CC}$	0 to 6.0	V
Power Supply Input for the MOSFET Switch	$V_{IN}$	0 to 6.0	V
SW Pin Switch Voltage	$V_{SW}$	-0.3 to $V_{IN}+0.3$	V
Enable Voltage	$V_{EN}$	-0.3 to $V_{IN}+0.3$	V
SW Pin Switch Current	$I_{SW}$	2.9	A
Power Dissipation (on PCB, $T_A=25^{\circ}C$ )	$P_D$	1.45	W
Thermal Resistance (Junction to Ambient, Simulation)	$\theta_{JA}$	68.63	$^{\circ}C/W$
Junction Temperature	$T_J$	160	$^{\circ}C$
Operating Temperature	$T_{OP}$	-40 to 85	$^{\circ}C$
Storage temperature	$T_{STG}$	-55 to 150	$^{\circ}C$
ESD (Human Body Model)	$V_{HBM}$	2000	V
ESD (Machine Model)	$V_{MM}$	200	V

Note 1: Stresses greater than those listed under “Absolute Maximum Ratings” may cause permanent damage to the device. These are stress ratings only, and functional operation of the device at these or any other conditions beyond those indicated under “Recommended Operating Conditions” is not implied. Exposure to “Absolute Maximum Ratings” for extended periods may affect device reliability.

**Recommended Operating Conditions**

Parameter	Symbol	Min	Max	Unit
Supply Input Voltage	$V_{IN}$	2.7	5.5	V
Junction Temperature Range	$T_J$	-40	125	$^{\circ}C$
Ambient Temperature Range	$T_A$	-40	80	$^{\circ}C$

**1.0MHz, 2.0A, Synchronous Step Down DC-DC Converter****AP3431****Electrical Characteristics**

$V_{IN}=V_{CC}=V_{EN}=5V$ ,  $V_{OUT}=1.2V$ ,  $V_{FB}=0.8V$ ,  $L=2.2\mu H$ ,  $C_{IN}=10\mu F$ ,  $C_{OUT}=22\mu F$ ,  $T_A=25^\circ C$ , unless otherwise specified.

Parameter	Symbol	Conditions	Min	Typ	Max	Unit
Input Voltage Range	$V_{IN}$		2.7		5.5	V
Shutdown Current	$I_{OFF}$	$V_{EN}=0V$		4		$\mu A$
Active Current	$I_{ON}$	$V_{FB} = 0.95V$		460		$\mu A$
Regulated Feedback Voltage	$V_{FB}$	For Adjustable Output Voltage	0.784	0.8	0.816	V
Regulated Output Voltage Accuracy	$\Delta V_{OUT}/V_{OUT}$	$V_{IN}=2.7V$ to $5.5V$ , $I_{OUT}=0$ to $2.0A$	-3		3	%
Peak Inductor Current	$I_{PK}$		2.9			A
Oscillator Frequency	$f_{OSC}$	$V_{IN} = 2.7V$ to $5.5V$		1.0		MHz
PMOSFET $R_{ON}$	$R_{ON(P)}$	$V_{IN} = 5V$		120		$m\Omega$
NMOSFET $R_{ON}$	$R_{ON(N)}$	$V_{IN} = 5V$		120		$m\Omega$
EN High-level Input Voltage	$V_{EN\_H}$		1.5			V
EN Low-level Input Voltage	$V_{EN\_L}$				0.4	V
EN Input Current	$I_{EN}$			2		$\mu A$
Soft-start Time	$t_{SS}$			450		$\mu s$
Maximum Duty Cycle	$D_{MAX}$		90			%
Under Voltage Lock Out Threshold		Rising		2.4		V
		Falling		2.3		V
		Hysteresis		0.1		V
Thermal Shutdown	$T_{SD}$	Hysteresis= $30^\circ C$		160		$^\circ C$

Typical Performance Characteristics

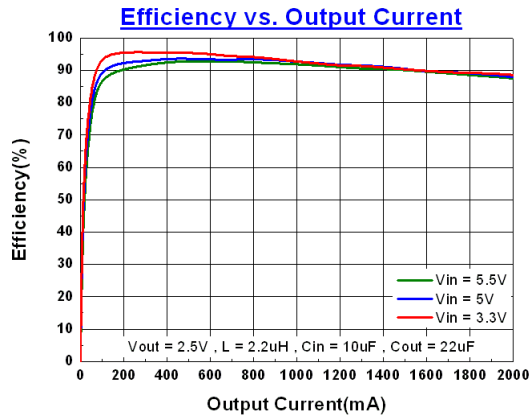

Figure 4. Efficiency vs. Output Current

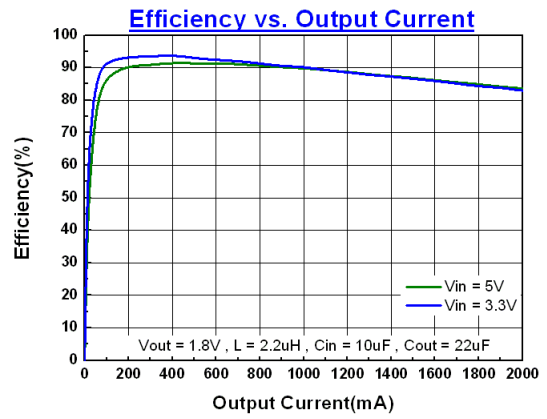

Figure 5. Efficiency vs. Output Current

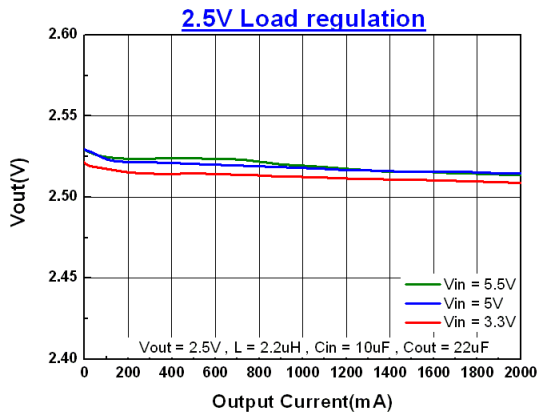

Figure 6. 2.5V Load Regulation

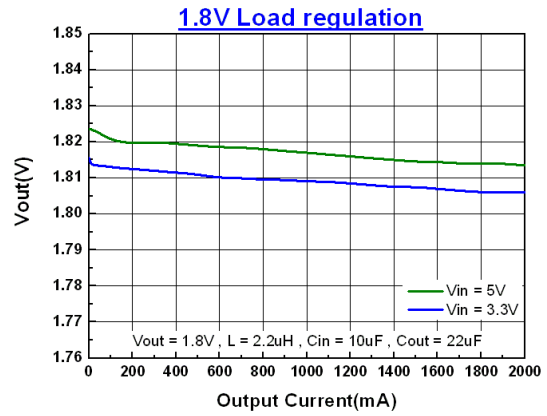

Figure 7. 1.8V Load Regulation

Typical Performance Characteristics (Continued)

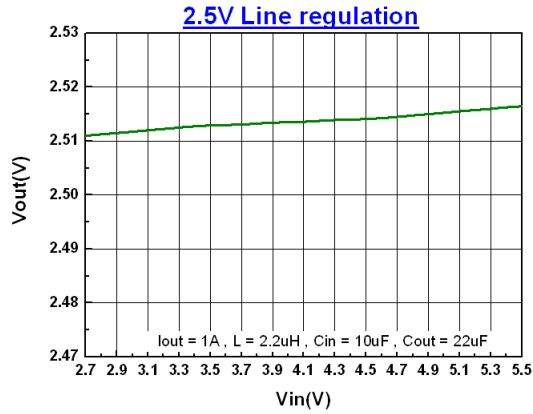

Figure 8. 2.5V Line Regulation

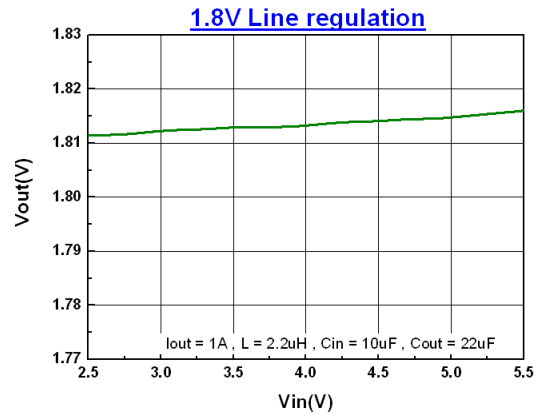

Figure 9. 1.8V Line Regulation

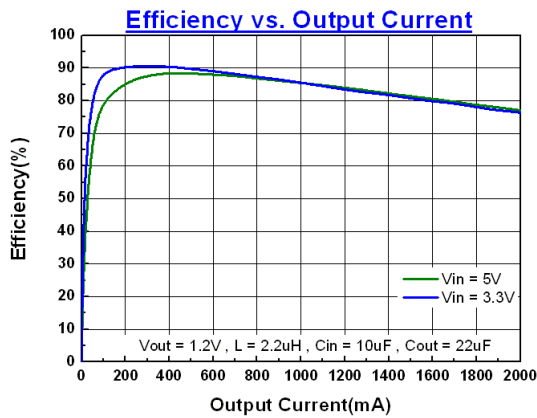

Figure 10. Efficiency vs. Output Current

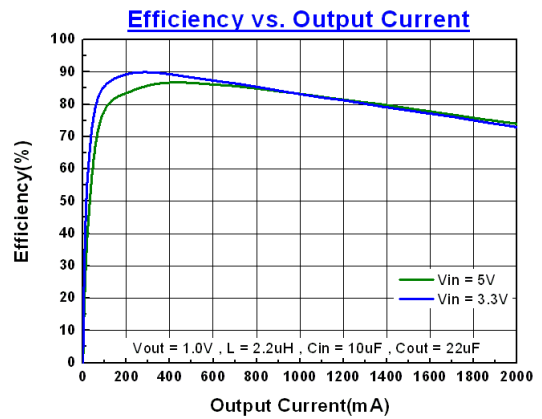

Figure 11. Efficiency vs. Output Current

Typical Performance Characteristics (Continued)

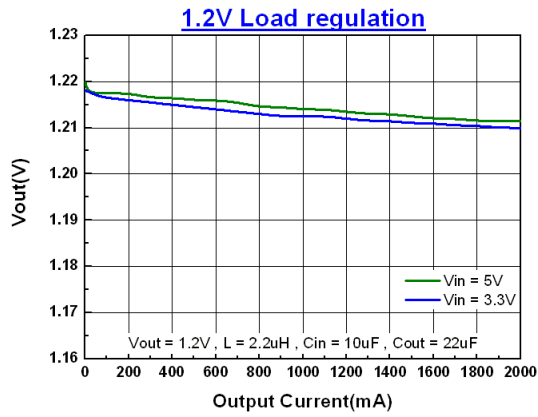

Figure 12. 1.2V Load Regulation

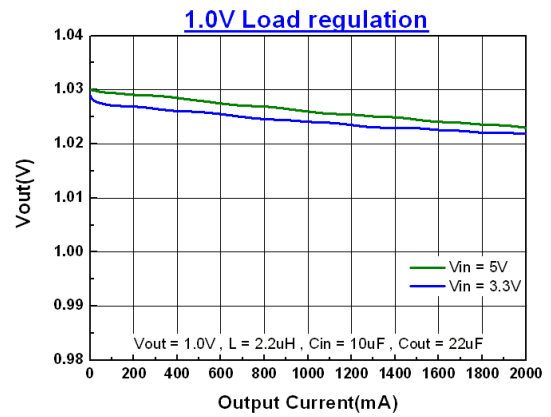

Figure 13. 1.0V Load Regulation

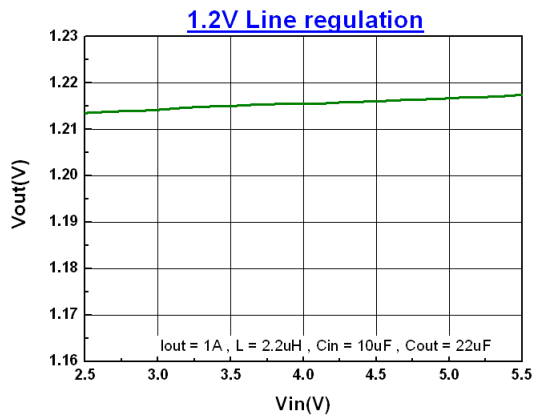

Figure 14. 1.2V Line Regulation

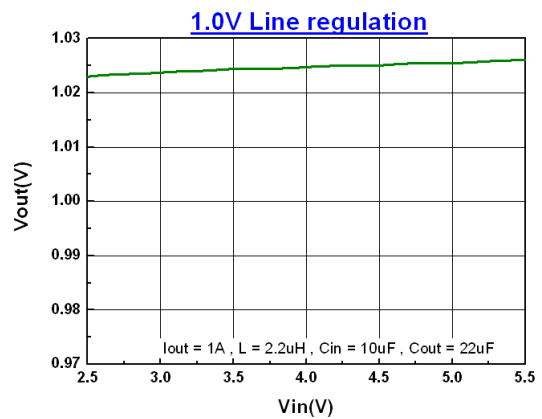

Figure 15. 1.0V Line Regulation



Typical Performance Characteristics (Continued)

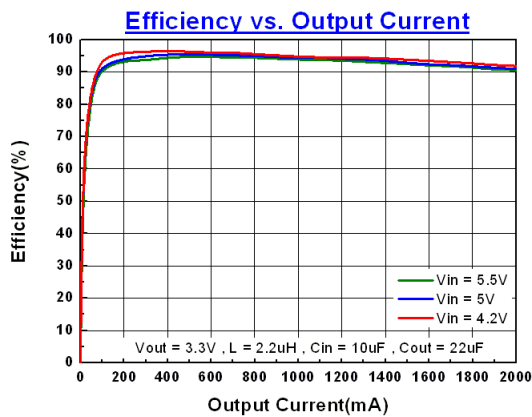

Figure 16. Efficiency vs. Output Current

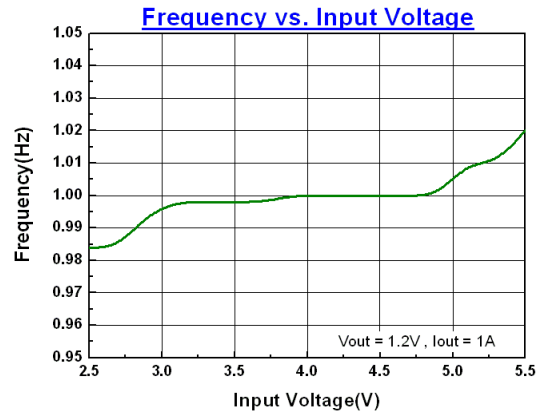

Figure 17. Frequency vs. Input Voltage

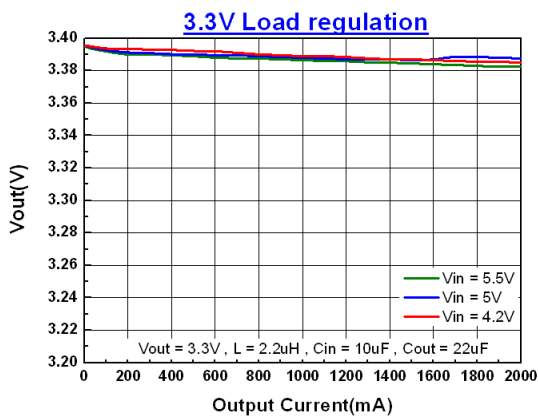

Figure 18. 3.3V Load Regulation

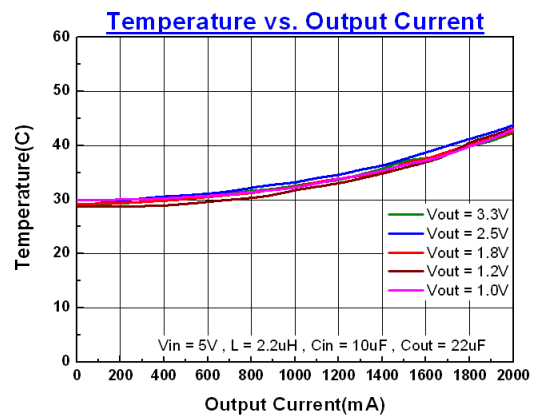

Figure 19. Temperature vs. Output Current

Typical Performance Characteristics (Continued)

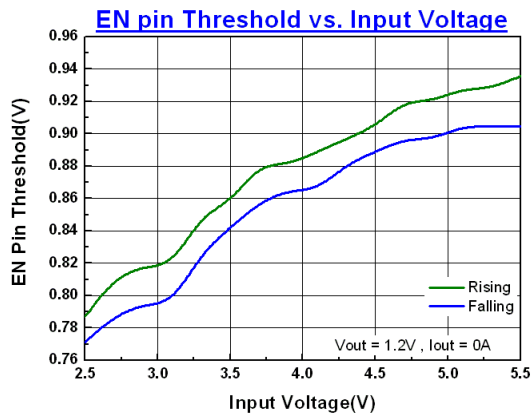

Figure 20. EN Pin Threshold vs. Input Voltage

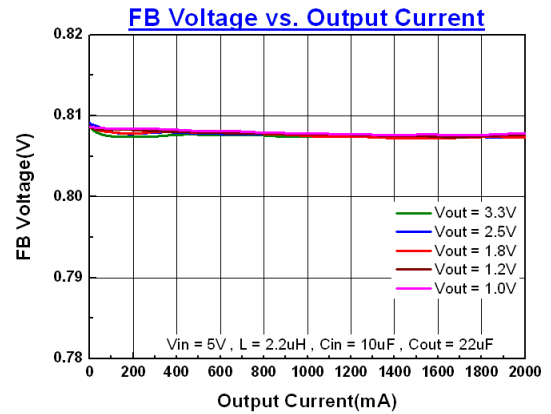

Figure 21. FB Voltage vs. Output Current

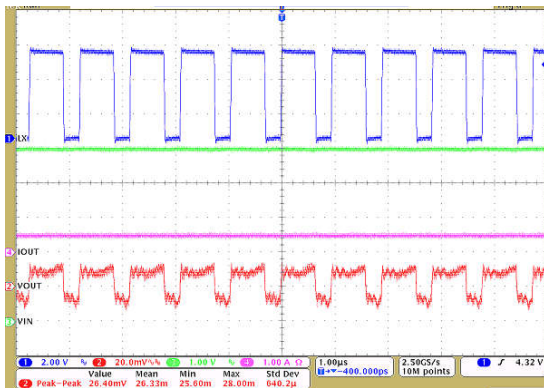

Figure 22.  $V_{OUT}$  Ripple  
( $V_{IN} = 5V$ ,  $V_{OUT} = 3.3V$ ,  $I_{OUT} = 500mA$ )

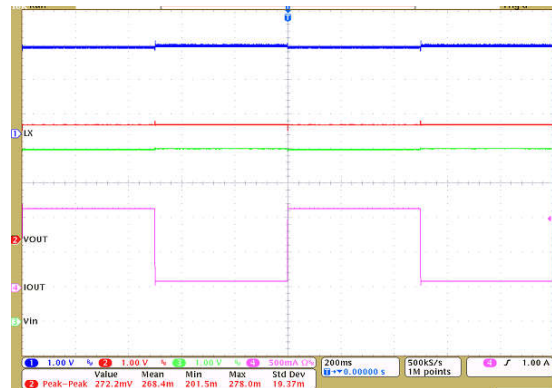

Figure 23. Dynamic Mode  
(Load=200mA to 1200mA,  $V_{IN} = 5V$ ,  $V_{OUT} = 3.3V$ )

Typical Performance Characteristics (Continued)

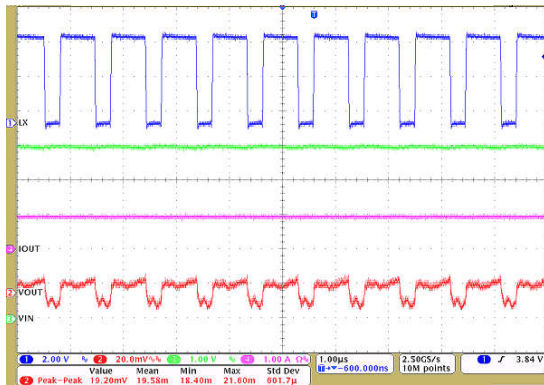

Figure 24. V<sub>OUT</sub> Ripple  
(V<sub>IN</sub>=5V, V<sub>OUT</sub>=3.3V, I<sub>OUT</sub>=1A)

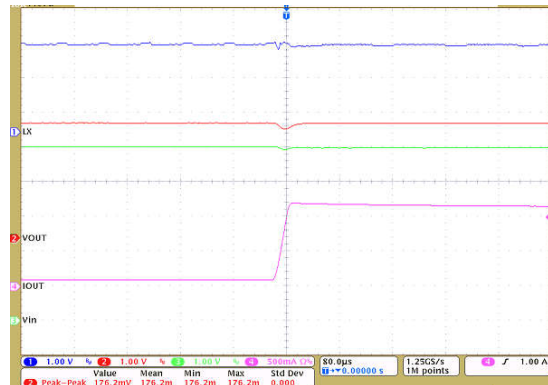

Figure 25. Dynamic Mode (Rising)

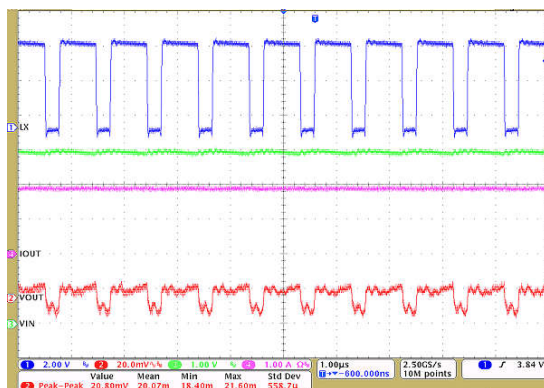

Figure 26. V<sub>OUT</sub> Ripple  
(V<sub>IN</sub>=5V, V<sub>OUT</sub>=3.3V, I<sub>OUT</sub>=2A)

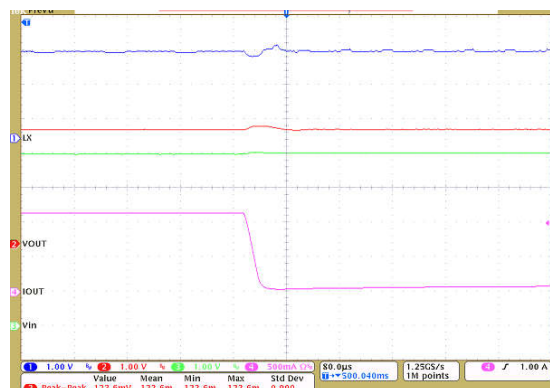

Figure 27. Dynamic Mode (Falling)

Typical Performance Characteristics (Continued)

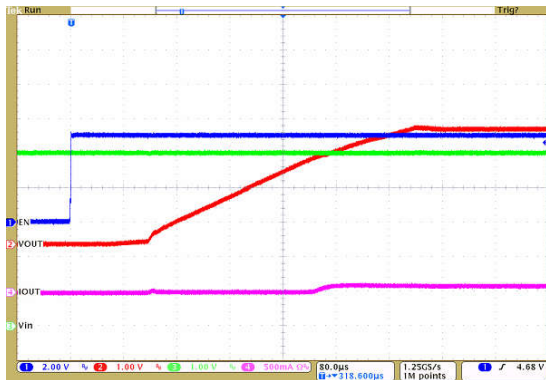

Figure 28. EN Pin, Low to High  
( $V_{IN}=5V$ ,  $V_{OUT}=3.3V$ ,  $I_{OUT}=100mA$ )

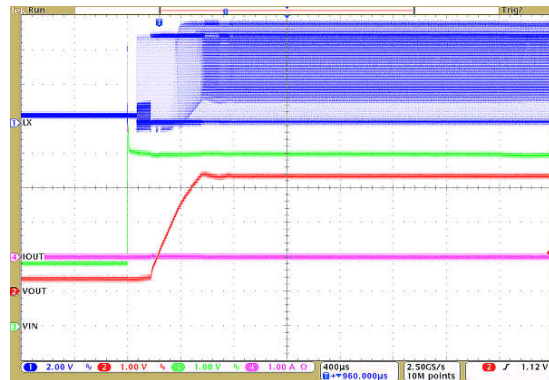

Figure 29. Soft Start  
( $V_{IN}=5V$ ,  $V_{OUT}=3.3V$ ,  $I_{OUT}=0A$ )

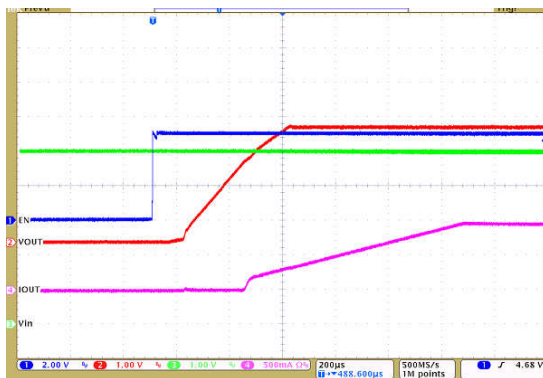

Figure 30. EN Pin, Low to High  
( $V_{IN}=5V$ ,  $V_{OUT}=3.3V$ ,  $I_{OUT}=1A$ )

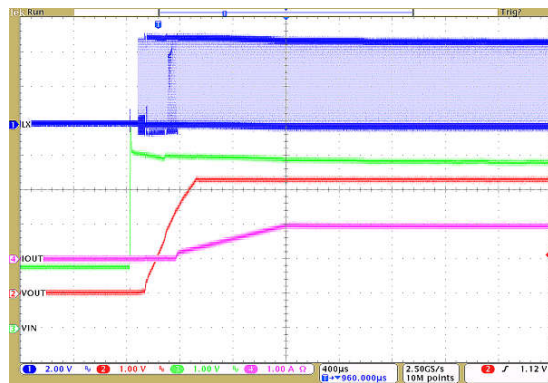

Figure 31. Soft Start  
( $V_{IN}=5V$ ,  $V_{OUT}=3.3V$ ,  $I_{OUT}=1A$ )

Typical Performance Characteristics (Continued)

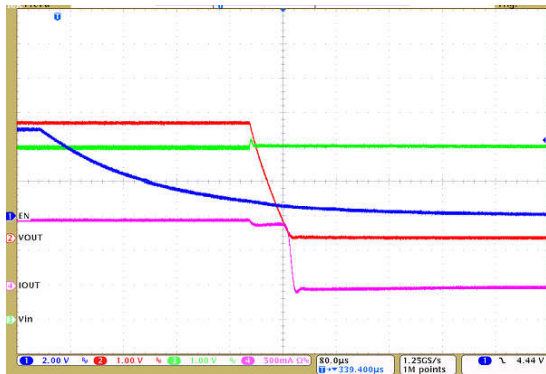

Figure 32. EN Pin, High to Low  
 ( $V_{IN}=5V$ ,  $V_{OUT}=3.3V$ ,  $I_{OUT}=1A$ )

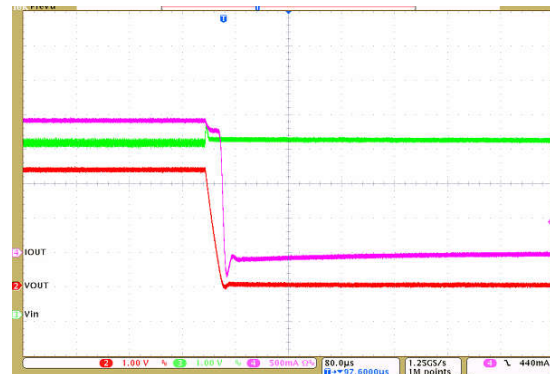

Figure 33. OTP

**1.0MHz, 2.0A, Synchronous Step Down DC-DC Converter**
**AP3431**

## Application Information

The basic AP3431 application circuit is shown in Figure 35, external components selection is determined by the load current and is critical with the selection of inductor and capacitor values.

### 1. Inductor Selection

For most applications, the value of inductor is chosen based on the required ripple current with the range of 1μH to 6.8μH.

$$\Delta I_L = \frac{1}{f \times L} V_{OUT} \left(1 - \frac{V_{OUT}}{V_{IN}}\right)$$

The largest ripple current occurs at the highest input voltage. Having a small ripple current reduces the ESR loss in the output capacitor and improves the efficiency. The highest efficiency is realized at low operating frequency with small ripple current. However, larger value inductors will be required. A reasonable starting point for ripple current setting is  $\Delta I_L = 40\% I_{MAX}$ . For a maximum ripple current stays below a specified value, the inductor should be chosen according to the following equation:

$$L = \left[ \frac{V_{OUT}}{f \times \Delta I_L (MAX)} \right] \left[ 1 - \frac{V_{OUT}}{V_{IN} (MAX)} \right]$$

The DC current rating of the inductor should be at least equal to the maximum output current plus half the highest ripple current to prevent inductor core saturation. For better efficiency, a lower DC-resistance inductor should be selected.

### 2. Capacitor Selection

The input capacitance,  $C_{IN}$ , is needed to filter the trapezoidal current at the source of the top MOSFET. To prevent large ripple voltage, a low ESR input capacitor sized for the maximum RMS current must be used. The maximum RMS capacitor current is given by:

$$I_{RMS} = I_{OMAX} \times \frac{[V_{OUT} (V_{IN} - V_{OUT})]^{\frac{1}{2}}}{V_{IN}}$$

It indicates a maximum value at  $V_{IN} = 2V_{OUT}$ , where  $I_{RMS} = I_{OUT}/2$ . This simple worst-case condition is commonly used for design because even significant

deviations do not much relieve. The selection of  $C_{OUT}$  is determined by the Effective Series Resistance (ESR) that is required to minimize output voltage ripple and load step transients, as well as the amount of bulk capacitor that is necessary to ensure that the control loop is stable. Loop stability can be also checked by viewing the load step transient response as described in the following section. The output ripple,  $\Delta V_{OUT}$ , is determined by:

$$\Delta V_{OUT} \leq \Delta I_L \left[ ESR + \frac{1}{8 \times f \times C_{OUT}} \right]$$

The output ripple is the highest at the maximum input voltage since  $\Delta I_L$  increases with input voltage.

### 3. Load Transient

A switching regulator typically takes several cycles to respond to the load current step. When a load step occurs,  $V_{OUT}$  immediately shifts by an amount equal to  $\Delta I_{LOAD} \times ESR$ , where ESR is the effective series resistance of output capacitor.  $\Delta I_{LOAD}$  also begins to charge or discharge  $C_{OUT}$  generating a feedback error signal used by the regulator to return  $V_{OUT}$  to its steady-state value. During the recovery time,  $V_{OUT}$  can be monitored for overshoot or ringing that would indicate a stability problem.

### 4. Output Voltage Setting

The output voltage of AP3431 can be adjusted by a resistive divider according to the following formula:

$$V_{OUT} = V_{REF} \times \left(1 + \frac{R_1}{R_2}\right) = 0.8V \times \left(1 + \frac{R_1}{R_2}\right)$$

The resistive divider senses the fraction of the output voltage as shown in Figure 34.

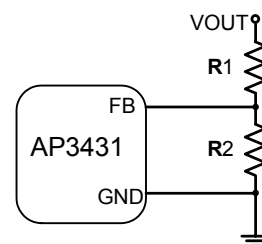

Figure 34. Setting the Output Voltage

## Application Information (Continued)

### 5. Short Circuit Protection

When the AP3431 output node is shorted to GND, as  $V_{FB}$  drop under 0.4V, the chip will enter soft-start mode to protect itself, when short circuit is removed, and  $V_{FB}$  rise over 0.4V, the AP3431 recover back to normal operation again. If the AP3431 reach OCP threshold while short circuit, the AP3431 will enter soft-start cycle until the current under OCP threshold.

### 6. Efficiency Considerations

The efficiency of switching regulator is equal to the output power divided by the input power times 100%. It is usually useful to analyze the individual losses to determine what is limiting efficiency and which change could produce the largest improvement. Efficiency can be expressed as:

$$\text{Efficiency} = 100\% - L_1 - L_2 - \dots$$

Where  $L_1$ ,  $L_2$ , etc. are the individual losses as a percentage of input power.

Although all dissipative elements in the regulator produce losses, two major sources usually account for most of the power losses:  $V_{IN}$  quiescent current and  $I^2R$  losses. The  $V_{IN}$  quiescent current loss dominates the efficiency loss at very light load currents and the  $I^2R$  loss dominates the efficiency loss at medium to heavy load currents.

**6.1** The  $V_{IN}$  quiescent current loss comprises two parts: the DC bias current as given in the electrical characteristics and the internal MOSFET switch gate charge currents. The gate charge current results from switching the gate capacitance of the internal power MOSFET switches. Each cycle the gate is switched from high to low, then to high again, and the packet of charge,  $dQ$  moves from  $V_{IN}$  to ground. The resulting  $dQ/dt$  is the current out of  $V_{IN}$  that is typically larger than the internal DC bias current. In continuous mode,

$$I_{GATE} = f \times (Q_P + Q_N)$$

Where  $Q_P$  and  $Q_N$  are the gate charge of power PMOSFET and NMOSFET switches. Both the DC bias current and gate charge losses are proportional to

the  $V_{IN}$  and this effect will be more serious at higher input voltages.

**6.2**  $I^2R$  losses are calculated from internal switch resistance,  $R_{SW}$  and external inductor resistance  $R_L$ . In continuous mode, the average output current flowing through the inductor is chopped between power PMOSFET switch and NMOSFET switch. Then, the series resistance looking into the SW pin is a function of both PMOSFET and NMOSFET  $R_{DS(ON)}$  resistance and the duty cycle ( $D$ ) are as follows:

$R_{DS(ON)}$  resistance and the duty cycle ( $D$ ):

$$R_{SW} = R_{DS(ON)P} \times D + R_{DS(ON)N} \times (1 - D)$$

Therefore, to obtain the  $I^2R$  losses, simply add  $R_{SW}$  to  $R_L$  and multiply the result by the square of the average output current.

Other losses including  $C_{IN}$  and  $C_{OUT}$  ESR dissipative losses and inductor core losses generally account for less than 2 % of total additional loss.

### 7. Thermal Characteristics

In most applications, the part does not dissipate much heat due to its high efficiency. However, in some conditions when the part is operating in high ambient temperature with high  $R_{DS(ON)}$  resistance and high duty cycles, such as in LDO mode, the heat dissipated may exceed the maximum junction temperature. To avoid the part from exceeding maximum junction temperature, the user should do some thermal analysis. The maximum power dissipation depends on the layout of PCB, the thermal resistance of IC package, the rate of surrounding airflow and the temperature difference between junction and ambient.

### 8. PCB Layout Considerations

When laying out the printed circuit board, the following checklist should be used to optimize the performance of AP3431.

- 1) The power traces, including the GND trace, the SW trace and the VIN trace should be kept direct, short and wide.
- 2) Put the input capacitor as close as possible to the V



---

**1.0MHz, 2.0A, Synchronous Step Down DC-DC Converter****AP3431**

---

**Application Information (Continued)**

-IN and GND pins.

3) The FB pin should be connected directly to the feedback resistor divider.

4) Keep the switching node, SW, away from the sensitive FB pin and the node should be kept small area.

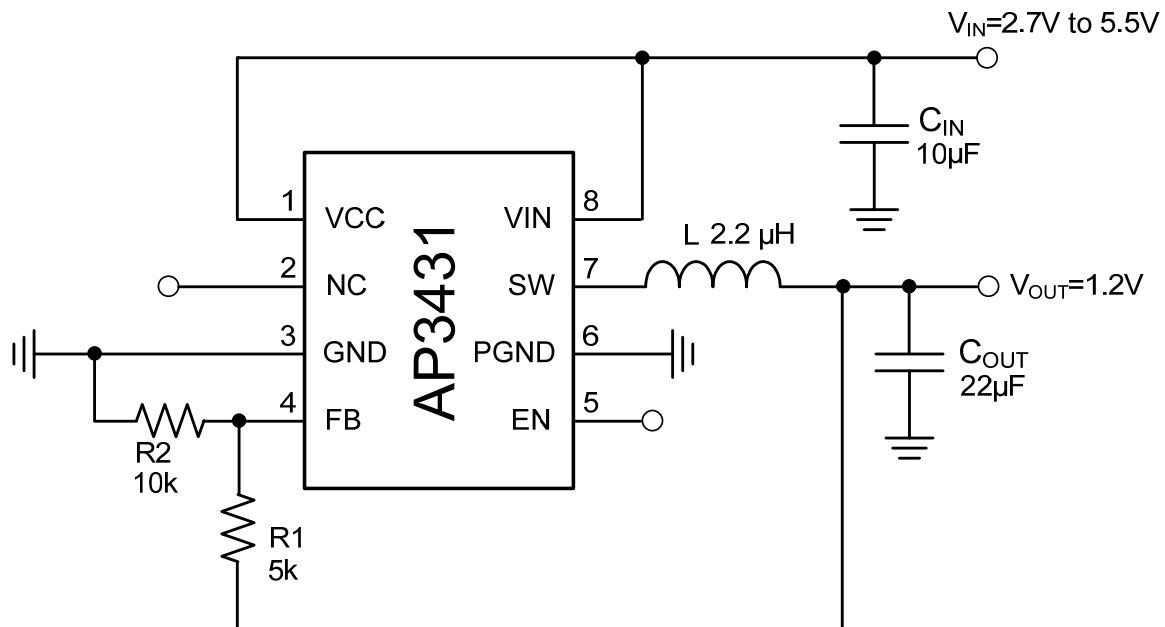

**1.0MHz, 2.0A, Synchronous Step Down DC-DC Converter**
**AP3431**
**Typical Application**

Note 2:  $V_{OUT} = V_{FB} \times \left(1 + \frac{R_1}{R_2}\right)$  .

Figure 35. Typical Application Circuit of AP3431

**Table 1. Component Guide**

V <sub>OUT</sub> (V)	R1(kΩ)	R2(kΩ)	L1(µH)
3.3	31.25	10	2.2
2.5	21.5	10	2.2
1.8	12.5	10	2.2
1.2	5	10	2.2
1.0	3	10	2.2

Mechanical Dimensions

SOIC-8

Unit: mm(inch)

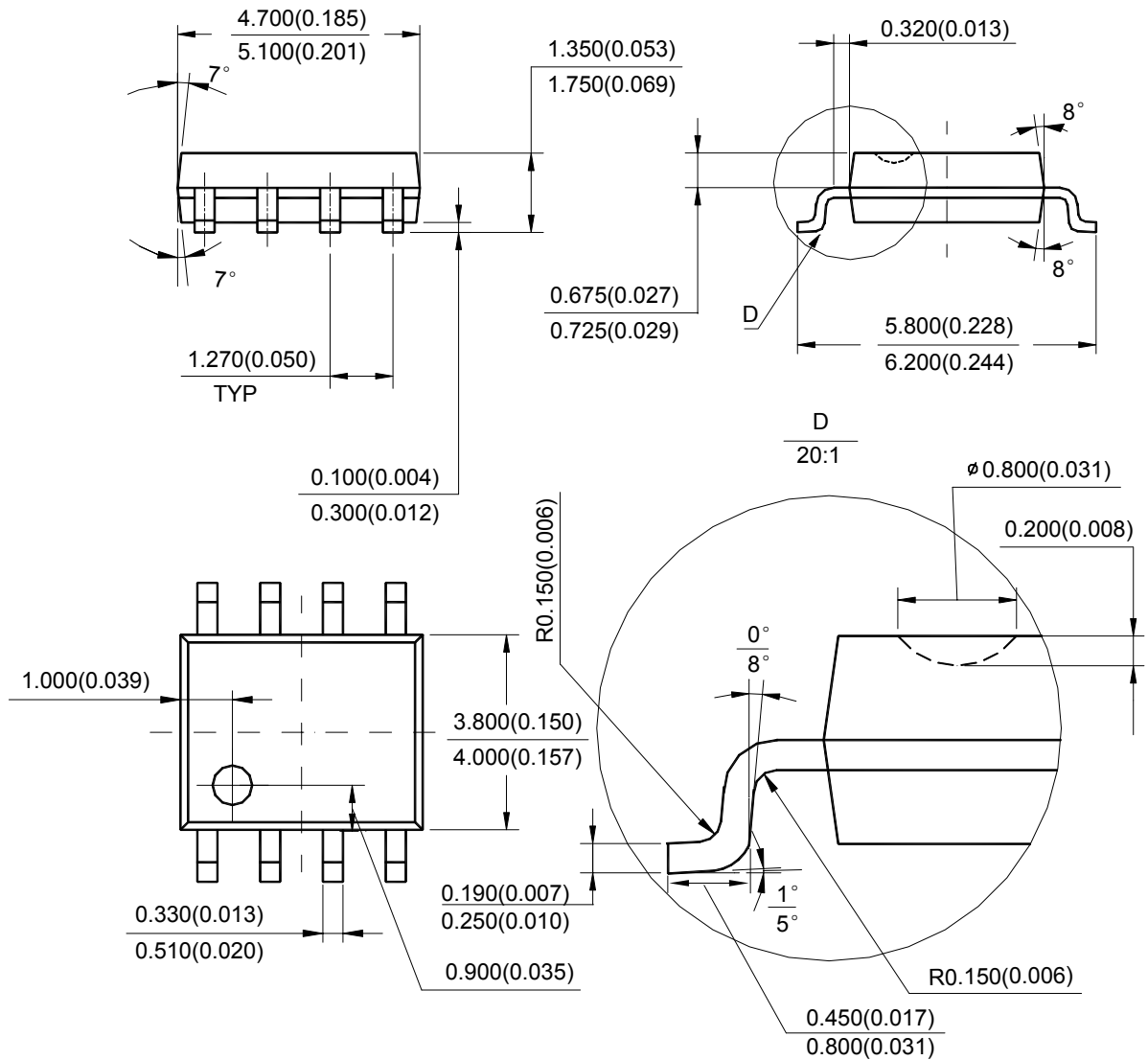

Note: Eject hole, oriented hole and mold mark is optional.



## **BCD Semiconductor Manufacturing Limited**

<http://www.bcdsemi.com>

### **IMPORTANT NOTICE**

BCD Semiconductor Manufacturing Limited reserves the right to make changes without further notice to any products or specifications herein. BCD Semiconductor Manufacturing Limited does not assume any responsibility for use of any its products for any particular purpose, nor does BCD Semiconductor Manufacturing Limited assume any liability arising out of the application or use of any its products or circuits. BCD Semiconductor Manufacturing Limited does not convey any license under its patent rights or other rights nor the rights of others.

---

#### **MAIN SITE**

##### **- Headquarters**

##### **BCD Semiconductor Manufacturing Limited**

No. 1600, Zi Xing Road, Shanghai Zizhu Science-based Industrial Park, 200241, China  
Tel: +86-21-24162266, Fax: +86-21-24162277

##### **- Wafer Fab**

##### **Shanghai SIM-BCD Semiconductor Manufacturing Co., Ltd.**

800 Yi Shan Road, Shanghai 200233, China  
Tel: +86-21-6485 1491, Fax: +86-21-5450 0008

#### **REGIONAL SALES OFFICE**

##### **Shenzhen Office**

##### **Shanghai SIM-BCD Semiconductor Manufacturing Co., Ltd., Shenzhen Office**

Unit A Room 1203, Skyworth Bldg., Gaoxin Ave. 1.S., Nanshan District, Shenzhen, China  
Tel: +86-755-8826 7951  
Fax: +86-755-8826 7865

##### **Taiwan Office**

##### **BCD Semiconductor (Taiwan) Company Limited**

4F, 298-1, Rui Guang Road, Nei-Hu District, Taipei, Taiwan  
Tel: +886-2-2656 2808  
Fax: +886-2-2656 2806

##### **USA Office**

##### **BCD Semiconductor Corp.**

30920 Huntwood Ave. Hayward, CA 94544, USA  
Tel : +1-510-324-2988  
Fax: +1-510-324-2788