

DELPHI SERIES



FEATURES

- ♦ High efficiency : 95% @ 12V/18A
- ♦ Size:
 - 57.9*36.8*10.5mm(2.28"*1.45"*0.41") (without heat spreader)
 - 57.9*36.8*12.2mm(2.28"*1.45"*0.48") (with heat spreader)
- ♦ Standard footprint
- ♦ Industry standard pin out
- ♦ Fixed frequency operation
- ♦ Input UVLO, Output OCP, OVP, OTP
- ♦ Hiccup output over current protection (OCP)
- ♦ Hiccup output over voltage protection (OVP)
- ♦ Auto recovery OTP and input UVLO
- ♦ 1500V isolation and basic insulation
- ♦ No minimum load required
- ♦ ISO 9001, TL 9000, ISO 14001, QS9000, OHSAS18001 certified manufacturing facility
- ♦ UL/cUL 60950-1 (US & Canada) recognized

Delphi Series Q48SQ, Quarter Brick Family DC/DC Power Modules: 36~75V in, 12V/18A out, 216W

The Delphi series Q48SQ12018, quarter brick, 36~75V input, single output, isolated DC/DC converter is the latest offering from a world leader in power system and technology and manufacturing — Delta Electronics, Inc. This product provides up to 216 watts of power in an industry standard footprint and pin out. With creative design technology and optimization of component placement, these converters possess outstanding electrical and thermal performances, as well as extremely high reliability under highly stressful operating conditions. The Q48SQ12018 offers more than 95% high efficiency at 18A full load. The Q48SQ12018 is fully protected from abnormal input/output voltage, current, and temperature conditions and meets all safety requirements with basic insulation.

OPTIONS

- ♦ Latched over current protection
- ♦ Positive/Negative On/Off logic
- ♦ Latched over voltage protection
- ♦ Heat spreader optional

APPLICATIONS

- ♦ Telecom / Datacom
- ♦ Wireless Networks
- ♦ Optical Network Equipment
- ♦ Server and Data Storage
- ♦ Industrial / Testing Equipment

TECHNICAL SPECIFICATIONS

(T_A=25°C, airflow rate=300 LFM, V_{in}=48Vdc, nominal V_{out} unless otherwise noted;

PARAMETER	NOTES and CONDITIONS	Q48SQ12018 (Standard)			
		Min.	Typ.	Max.	Units
ABSOLUTE MAXIMUM RATINGS					
Input Voltage					
Continuous				80	Vdc
Transient	100ms			100	Vdc
Operating Ambient Temperature		-40		85	°C
Storage Temperature		-55		125	°C
Input/Output Isolation Voltage				1500	Vdc
INPUT CHARACTERISTICS					
Operating Input Voltage		36	48	75	Vdc
Input Under-Voltage Lockout					
Turn-On Voltage Threshold		33	34	35	Vdc
Turn-Off Voltage Threshold		31	32	33	Vdc
Lockout Hysteresis Voltage			2		Vdc
Maximum Input Current				9	A
No-Load Input Current	V _{in} =48V, I _o =0A		100		mA
Off Converter Input Current	V _{in} =48V, I _o =0A		9	13	mA
Inrush Current (I ² t)				1	A ² s
Input Reflected-Ripple Current	P-P thru 12μH inductor, 5Hz to 20MHz		20		mA
Input Voltage Ripple Rejection	120 Hz		-30		dB
OUTPUT CHARACTERISTICS					
Output Voltage Set Point	V _{in} =48V, I _o =0, T _c =25°C	11.88	12.00	12.12	Vdc
Output Voltage Regulation					
Over Load	V _{in} =48V, I _o =I _{o,min} to I _{o,max}		±10	±30	mV
Over Line	V _{in} =36V to 75V, I _o =I _{o,min}		±10	±30	mV
Over Temperature	V _{in} =48V, T _c =-40°C to 85°C		±60		mV
Total Output Voltage Range	over sample load, line and temperature	11.64		12.36	Vdc
Output Voltage Ripple and Noise	5Hz to 20MHz bandwidth				
Peak-to-Peak	Full Load, 1μF ceramic, 10μF tantalum		100	150	mV
RMS	Full Load, 1μF ceramic, 10μF tantalum		25	50	mV
Operating Output Current Range		0		18	A
Output DC Current-Limit Inception	Output Voltage 10% Low	21	23	25	A
DYNAMIC CHARACTERISTICS					
Output Voltage Current Transient	48V, 100μF Al Ecap, 10μF Tan & 1μF Ceramic load cap, 0.1A/μs				
Positive Step Change in Output Current	50% I _{o,max} to 75% I _{o,max}		200		mV
Negative Step Change in Output Current	75% I _{o,max} to 50% I _{o,max}		200		mV
Settling Time (within 1% V _{out} nominal)			300		us
Turn-On Transient					
Start-Up Time, From On/Off Control			100		ms
Start-Up Time, From Input			100		ms
Maximum Output Capacitance	Low ESR CAP (OSCON), 100% load;	0		5500	μF
EFFICIENCY					
100% Load	V _{in} =48V		94.7		%
60% Load	V _{in} =48V		94.9		%
ISOLATION CHARACTERISTICS					
Input to Output				1500	Vdc
Isolation Resistance		10			MΩ
Isolation Capacitance			6800		pF
FEATURE CHARACTERISTICS					
Switching Frequency			130		kHz
ON/OFF Control, Negative Remote On/Off logic					
Logic Low (Module On)	V _{on/off} at I _{on/off} =1.0mA	0		0.8	V
Logic High (Module Off)	V _{on/off} at I _{on/off} =0.0 μA	2		50	V
ON/OFF Control, Positive Remote On/Off logic					
Logic Low (Module Off)	V _{on/off} at I _{on/off} =1.0mA	0		0.8	V
Logic High (Module On)	V _{on/off} at I _{on/off} =0.0 μA	2		50	V
ON/OFF Current (for both remote on/off logic)	I _{on/off} at V _{on/off} =0.0V			1	mA
Leakage Current (for both remote on/off logic)	Logic High, V _{on/off} =15V			50	uA
Output Over-Voltage Protection	Over full temp range; % of nominal V _{out}	115	125	140	%
Output voltage trim range	P _{out} ≤Max rated power	-20		10	%
GENERAL SPECIFICATIONS					
MTBF(with heat spreader)	I _o =80% of I _{o,max} ; T _c =25°C; Airflow=300LFM		2		M hours
Weight(without heat spreader)			50.0		grams
Weight(with heat spreader)			65.5		grams
Over-Temperature Shutdown (without heat spreader)	Refer to Figure 21 for Hot spot location (48V _{in} , 80% I _o , 200LFM, Airflow from Vin+ to Vin-)		130		°C
Over-Temperature Shutdown (with heat spreader)	Refer to Figure 23 for Hot spot location (48V _{in} , 80% I _o , 200LFM, Airflow from Vin+ to Vin-)		123		°C
Over-Temperature Shutdown (NTC Resistor)	Refer to Figure 21 NTC resistor location		125		°C

Note: Please attach thermocouple on NTC resistor to test OTP function, the hot spot's temperature is just for reference.



ELECTRICAL CHARACTERISTICS CURVES

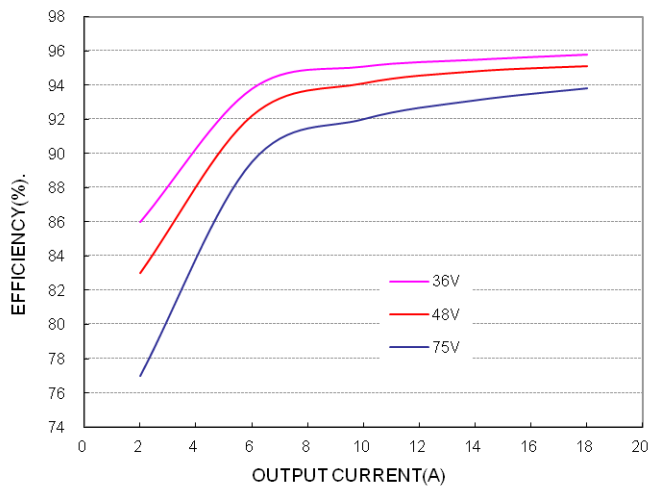

Figure 1: Efficiency vs. load current for minimum, nominal, and maximum input voltage at 25°C.

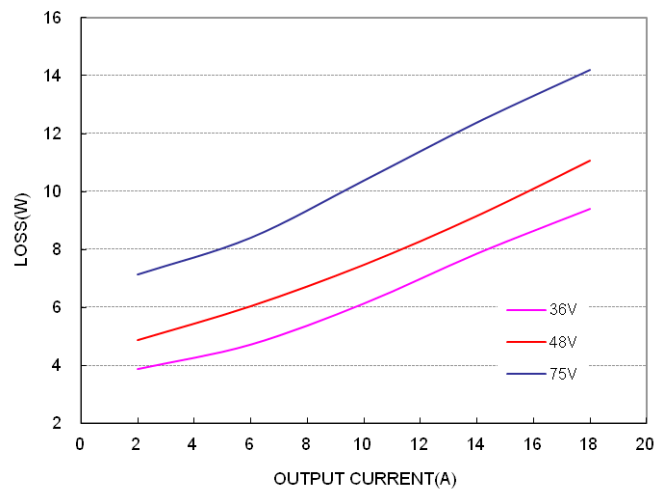

Figure 2: Power dissipation vs. load current for minimum, nominal, and maximum input voltage at 25°C.

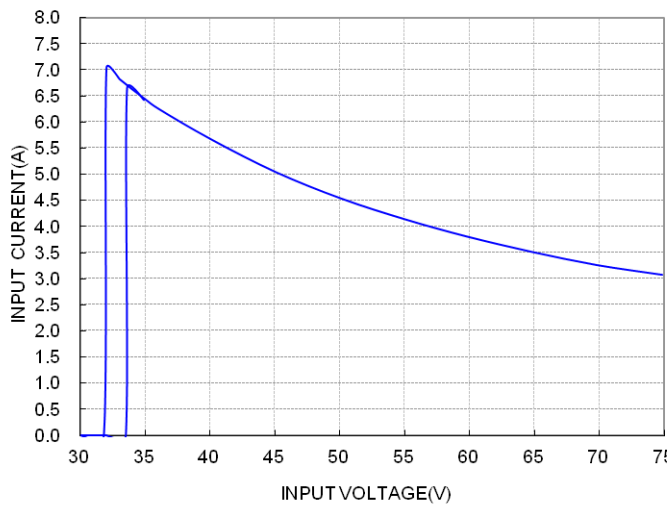

Figure 3: Typical full load input characteristics at room temperature.



ELECTRICAL CHARACTERISTICS CURVES

For Negative Remote On/Off Logic

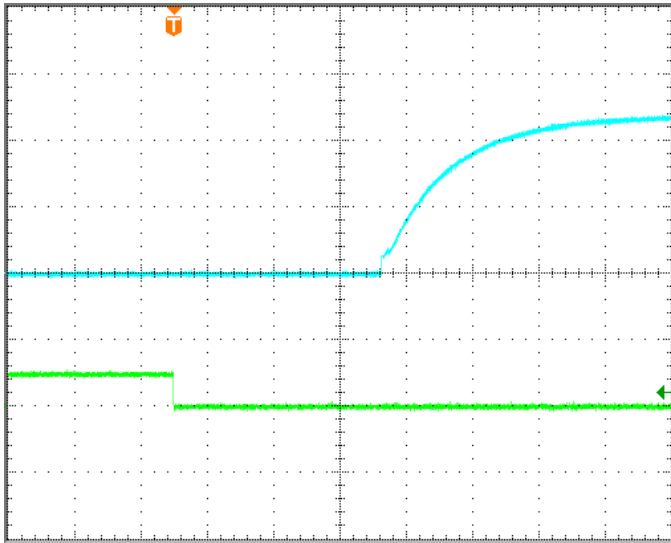

Figure 4: Turn-on transient at zero load current) (20ms/div). Top Trace: Vout; 5V/div; Bottom Trace: ON/OFF input: 5V/div.

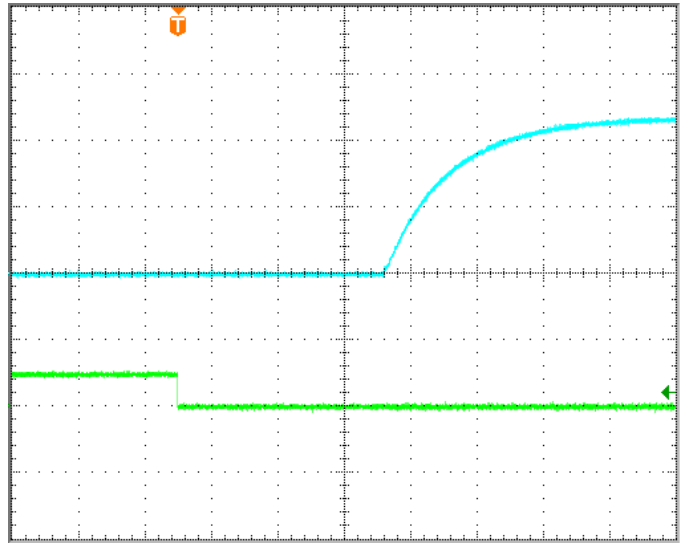

Figure 5: Turn-on transient at full rated load current (20 ms/div). Top Trace: Vout: 5V/div; Bottom Trace: ON/OFF input: 5V/div.

For Input Voltage Start up

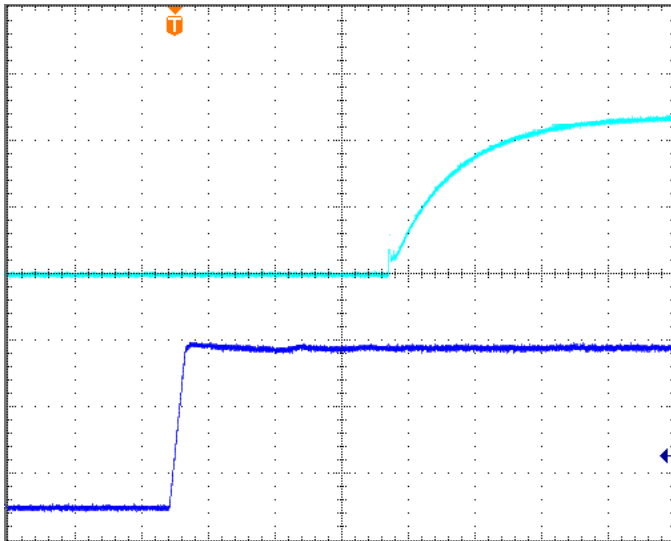

Figure 6: Turn-on transient at zero load current (20 ms/div). Top Trace: Vout; 5V/div; Bottom Trace: input voltage: 20V/div.

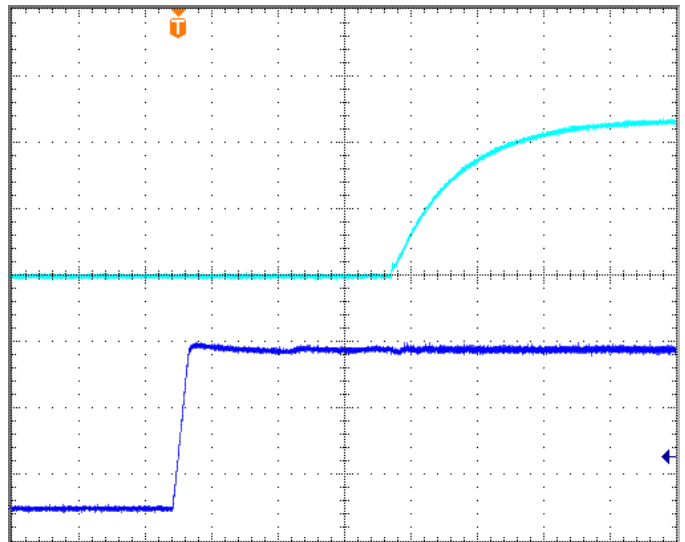

Figure 7: Turn-on transient at full rated load current (20 ms/div). Top Trace: Vout; 5V/div; Bottom Trace: input voltage: 20V/div.

ELECTRICAL CHARACTERISTICS CURVES

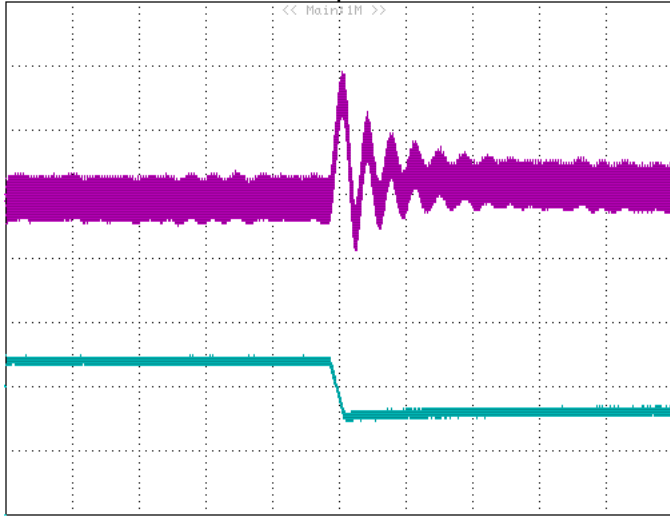

Figure 8: Output voltage response to step-change in load current (75%-50% of I_o , max; $di/dt = 0.1A/\mu s$). Load cap: 100uF Al-Electrolytic capacitor, 10uF tantalum capacitor and 1uF ceramic capacitor. Top Trace: V_{out} ; 200mV/div; Bottom Trace: output current: 5A/div, Time: 200us/div

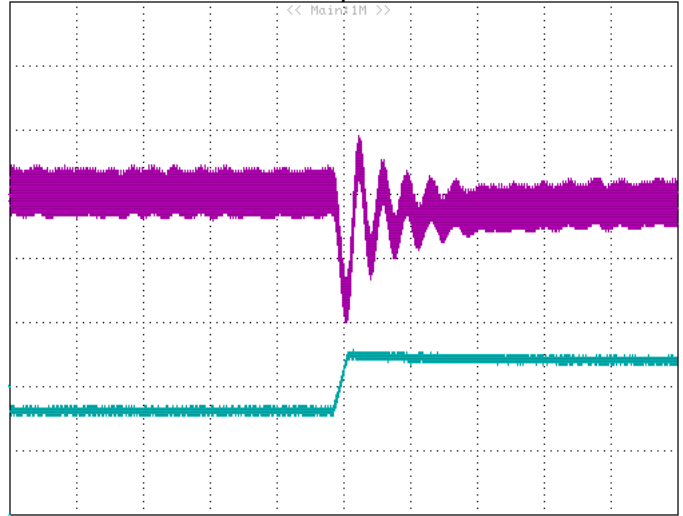

Figure 9: Output voltage response to step-change in load current (50%-75% of I_o , max; $di/dt = 0.1A/\mu s$). Load cap: 100uF Al-Electrolytic capacitor, 10uF tantalum capacitor and 1uF ceramic capacitor. Top Trace: V_{out} ; 200mV/div; Bottom Trace: output current: 5A/div, Time: 200us/div

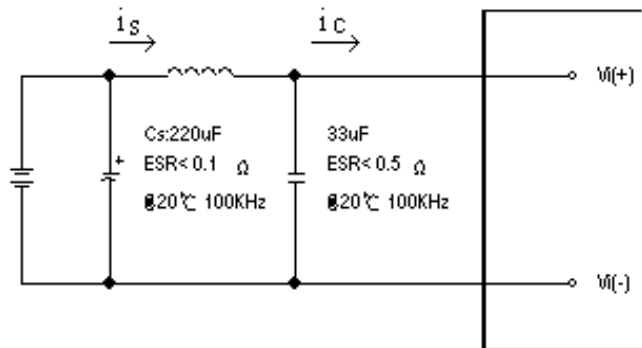

Figure 10: Test set-up diagram showing measurement points for Input Terminal Ripple Current and Input Reflected Ripple Current.

Note: Measured input reflected-ripple current with a simulated source Inductance (L_{TEST}) of 12 μH . Capacitor C_s offset possible battery impedance. Measure current as shown above.

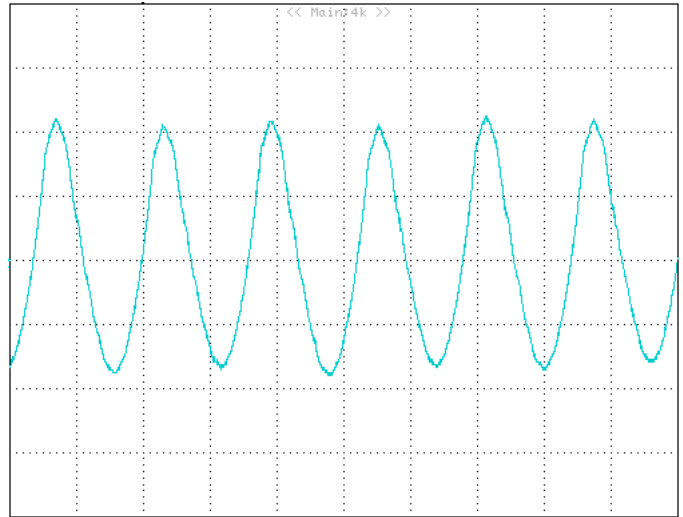

Figure 11: Input Terminal Ripple Current, i_c , at full rated output current and nominal input voltage with 12uH source impedance and 33uF electrolytic capacitor (200 mA/div, 2us/div).



ELECTRICAL CHARACTERISTICS CURVES

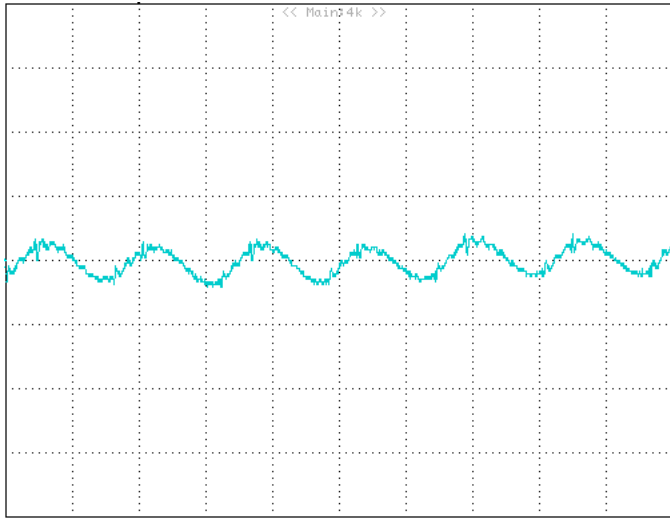

Figure 12: Input reflected ripple current, i_s , through a $12\mu\text{H}$ source inductor at nominal input voltage and rated load current (20 mA/div , $2\mu\text{s/div}$).

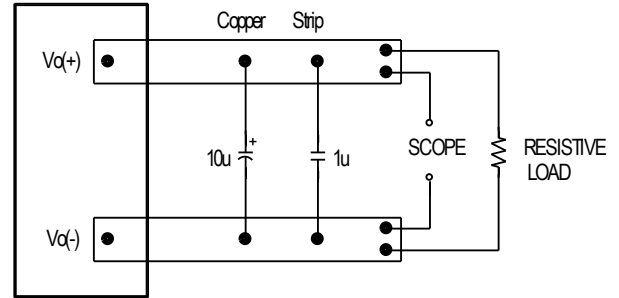

Figure 13: Output voltage noise and ripple measurement test setup.

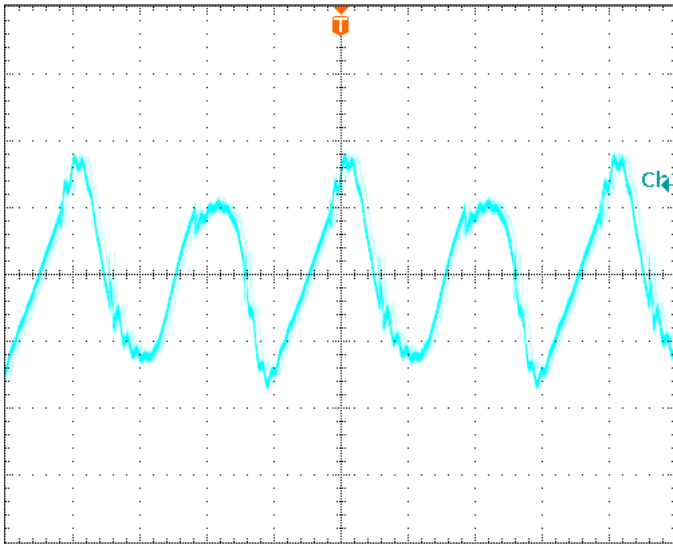

Figure 14: Output voltage ripple at nominal input voltage and rated load current ($I_o=18\text{A}$) (30 mV/div , $2\mu\text{s/div}$)
Load capacitance: $1\mu\text{F}$ ceramic capacitor and $10\mu\text{F}$ tantalum capacitor. Bandwidth: 20 MHz .

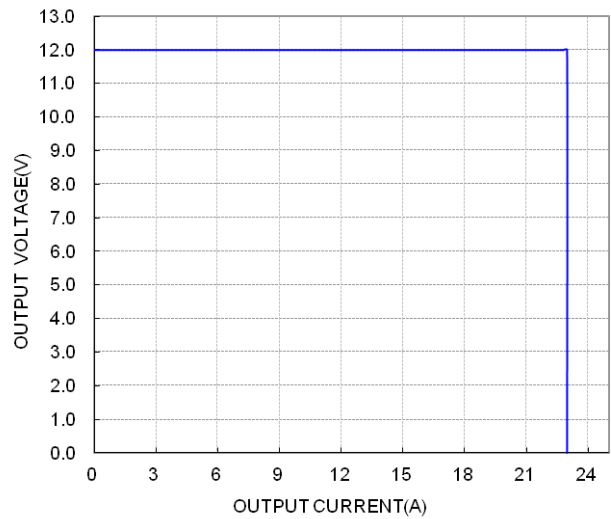

Figure 15: Output voltage vs. load current at nominal input voltage showing typical current limit curves and converter shutdown points.

DESIGN CONSIDERATIONS

Input Source Impedance

The impedance of the input source connecting to the DC/DC power modules will interact with the modules and affect the stability. A low ac-impedance input source is recommended. If the source inductance is more than a few μH , we advise adding a $10\mu\text{F}$ to $100\mu\text{F}$ electrolytic capacitor (ESR $< 0.7 \Omega$ at 100 kHz) mounted close to the input of the module to improve the stability.

Layout and EMC Considerations

Delta's DC/DC power modules are designed to operate in a wide variety of systems and applications. For design assistance with EMC compliance and related PWB layout issues, please contact Delta's technical support team. An external input filter module is available for easier EMC compliance design. Below is the reference design for an input filter tested with Q48SQ12018 series to meet class B in CISPR 22.

Schematic and Components List:

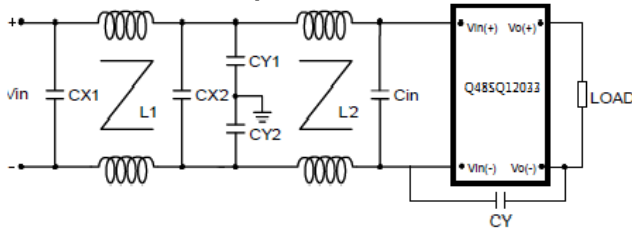

Cin is 100uF low ESR Aluminum cap;
 CY is 1nF ceramic cap;
 CX1 is 1uF*3 ceramic cap;
 CX2 is 1uF*2 ceramic cap;
 CY1,CY2 are 100nF*2 ceramic cap;
 L1,L2 are common-mode inductor,L1=L2=0.47mH.
Test Result: Vin=48V,Io=18A,

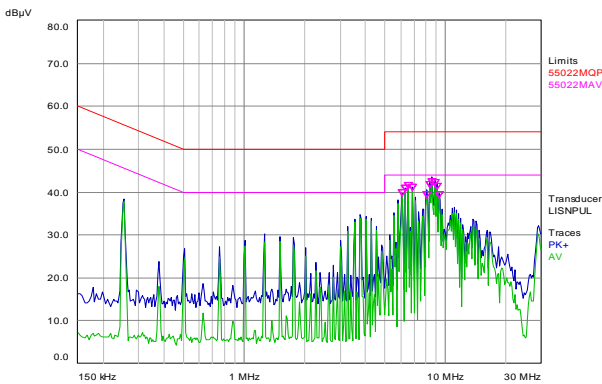

Blue Line is quasi peak mode; Green line is average mode.

Safety Considerations

The power module must be installed in compliance with the spacing and separation requirements of the end-user's safety agency standard, i.e., UL60950-1,

CAN/CSA-C22.2, No. 60950-1 and EN60950-1+A11 and IEC60950-1, if the system in which the power module is to be used must meet safety agency requirements.

Basic insulation based on 75 Vdc input is provided between the input and output of the module for the purpose of applying insulation requirements when the input to this DC-to-DC converter is identified as TNV-2 or SELV. An additional evaluation is needed if the source is other than TNV-2 or SELV.

When the input source is SELV circuit, the power module meets SELV (safety extra-low voltage) requirements. If the input source is a hazardous voltage which is greater than 60 Vdc and less than or equal to 75 Vdc, for the module's output to meet SELV requirements, all of the following must be met:

- The input source must be insulated from the ac mains by reinforced or double insulation.
- The input terminals of the module are not operator accessible.
- If the metal baseplate is grounded, the output must be also grounded.
- A SELV reliability test is conducted on the system where the module is used, in combination with the module, to ensure that under a single fault, hazardous voltage does not appear at the module's output.

When installed into a Class II equipment (without grounding), spacing consideration should be given to the end-use installation, as the spacing between the module and mounting surface have not been evaluated.

The power module has extra-low voltage (ELV) outputs when all inputs are ELV.

This power module is not internally fused. To achieve optimum safety and system protection, an input line fuse is highly recommended. The safety agencies require a normal-blow fuse with 10A maximum rating to be installed in the ungrounded lead. A lower rated fuse can be used based on the maximum inrush transient energy and maximum input current.

Soldering and Cleaning Considerations

Post solder cleaning is usually the final board assembly process before the board or system undergoes electrical testing. Inadequate cleaning and drying may lower the reliability of a power module and severely affect the finished circuit board assembly test. Adequate cleaning and drying is especially important for un-encapsulated and/or open frame type power modules. For assistance on appropriate soldering and cleaning procedures, please contact Delta's technical support team.

FEATURES DESCRIPTIONS

Over-Current Protection

The modules include an internal output over-current protection circuit, which will endure current limiting for an unlimited duration during output overload. If the output current exceeds the OCP set point, the modules will shut down (hiccup mode). The hiccup time will last 500ms.

The modules will try to restart after shutdown. If the overload condition still exists, the module will shut down again. This restart trial will continue until the overload condition is corrected.

Over-Voltage Protection

The modules include an internal output over-voltage protection circuit, which monitors the voltage on the output terminals. If this voltage exceeds the over-voltage threshold, the modules will shut down, (hiccup mode). The hiccup time will last 500ms.

The modules will try to restart after shutdown. If the overvoltage condition still exists, the module will shut down again. This restart trial will continue until the overvoltage condition is corrected.

Over-Temperature Protection

The over-temperature protection consists of circuitry that provides protection from thermal damage. If the temperature exceeds the over-temperature threshold the module will shut down. The module will restart after the temperature is within specification.

Remote On/Off

The remote on/off feature on the module can be either negative or positive logic. Negative logic turns the module on during a logic low and off during a logic high. Positive logic turns the modules on during a logic high and off during a logic low.

Remote on/off can be controlled by an external switch between the on/off terminal and the Vi (-) terminal. The switch can be an open collector or open drain.

For negative logic if the remote on/off feature is not used, please short the on/off pin to Vi (-). For positive logic if the remote on/off feature is not used, please leave the on/off pin to floating.

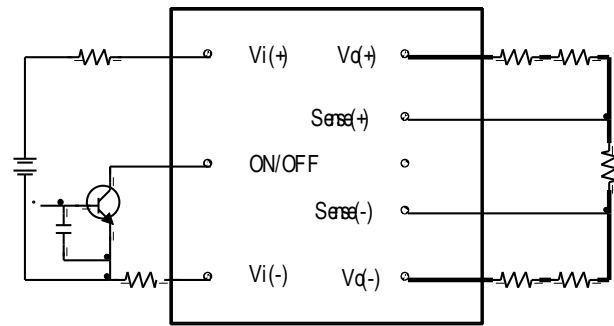

Figure 16: Remote on/off implementation

Remote Sense

Remote sense compensates for voltage drops on the output by sensing the actual output voltage at the point of load. The voltage between the remote sense pins and the output terminals must not exceed the output voltage sense range given here:

$$[Vo(+) - Vo(-)] - [SENSE(+) - SENSE(-)] \leq 10\% \times V_{out}$$

This limit includes any increase in voltage due to remote sense compensation and output voltage set point adjustment (trim).

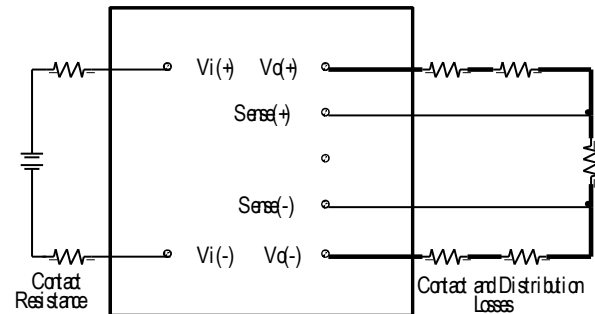

Figure 17: Effective circuit configuration for remote sense operation

If the remote sense feature is not used to regulate the output at the point of load, please connect SENSE(+) to Vo(+) and SENSE(-) to Vo(-) at the module.

The output voltage can be increased by both the remote sense and the trim; however, the maximum increase is the larger of either the remote sense or the trim, not the sum of both.

When using remote sense and trim, the output voltage of the module is usually increased. And it will increase the output power of the module with the same output current.

Care should be taken to ensure that the maximum output power does not exceed the maximum rated power.

Output Voltage Adjustment (TRIM)

To increase or decrease the output voltage set point, the modules may be connected with an external resistor between the TRIM pin and either the SENSE(+) or SENSE(-). The TRIM pin should be left open if this feature is not used.

Trim down:

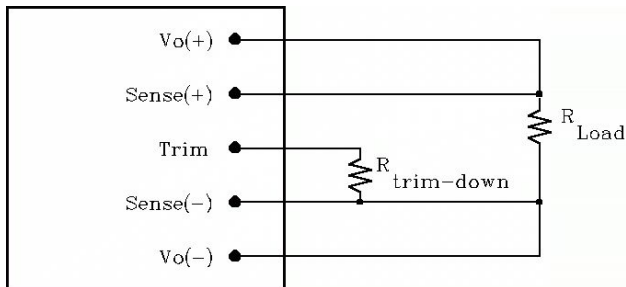

Figure 18: Circuit configuration for trim-down (decrease output voltage)

If the external resistor is connected between the TRIM and SENSE (-) pins, the output voltage set point decreases (Fig. 18). The external resistor value required to obtain a percentage of output voltage change $\Delta\%$ is defined as:

$$R_{trim-down} = \frac{511}{\Delta} - 10.2(K\Omega)$$

Trim up:

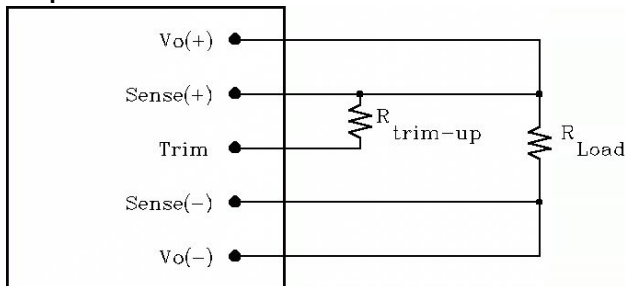

Figure 19: Circuit configuration for trim-up (increase output voltage)

If the external resistor is connected between the TRIM and SENSE (+) the output voltage set point increases (Fig. 19). The external resistor value required to obtain a percentage output voltage change $\Delta\%$ is defined as:

$$R_{trim-up} = \frac{5.11V_o(100 + \Delta)}{1.225\Delta} - \frac{511}{\Delta} - 10.2(K\Omega)$$

THERMAL CONSIDERATIONS

Thermal management is an important part of the system design. To ensure proper, reliable operation, sufficient cooling of the power module is needed over the entire temperature range of the module. Convection cooling is usually the dominant mode of heat transfer.

Hence, the choice of equipment to characterize the thermal performance of the power module is a wind tunnel.

Thermal Testing Setup

Delta's DC/DC power modules are characterized in heated vertical wind tunnels that simulate the thermal environments encountered in most electronics equipment. This type of equipment commonly uses vertically mounted circuit cards in cabinet racks in which the power modules are mounted.

The following figure shows the wind tunnel characterization setup. The power module is mounted on a test PWB and is vertically positioned within the wind tunnel. The space between the neighboring PWB and the top of the power module is constantly kept at 6.35mm (0.25").

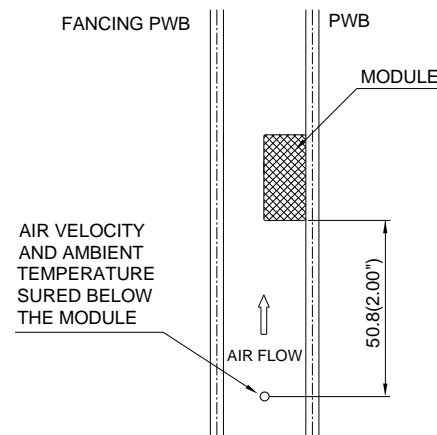

Note: Wind Tunnel Test Setup Figure Dimensions are in millimeters and (Inches)

Figure 20: Wind tunnel test setup

Thermal Derating

Heat can be removed by increasing airflow over the module. To enhance system reliability, the power module should always be operated below the maximum operating temperature. If the temperature exceeds the maximum module temperature, reliability of the unit may be affected.

THERMAL CURVES (WITHOUT HEAT SPREADER)

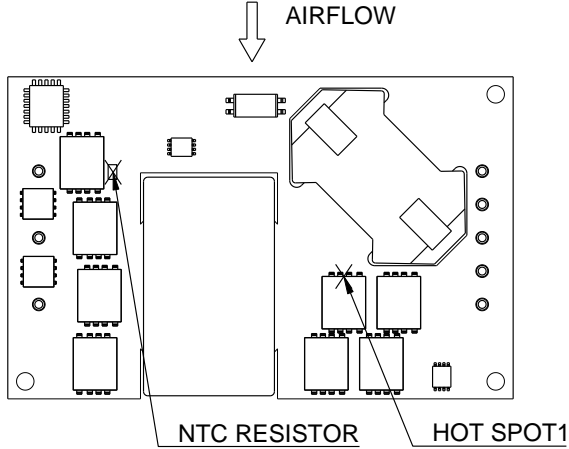

Figure 21: * Hot spot1 and NTC resistor temperature measured point. The allowed maximum hot spot1 temperature is defined at 115°C.

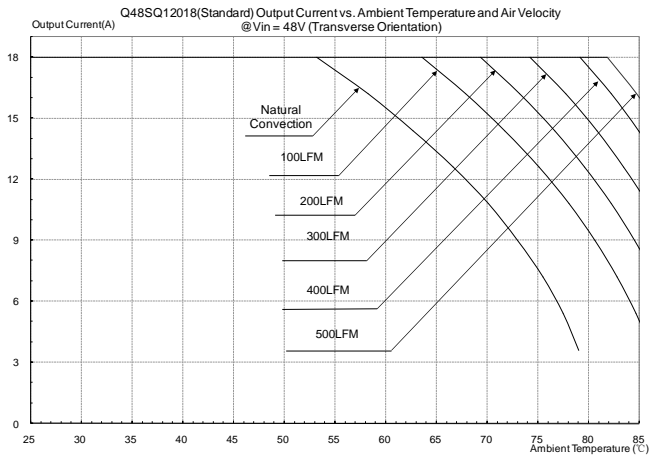

Figure 22: Output current vs. ambient temperature and air velocity @Vin=48V(Transverse Orientation, airflow from Vin+ to Vin-, without heat spreader)

THERMAL CURVES (WITH HEAT SPREADER)

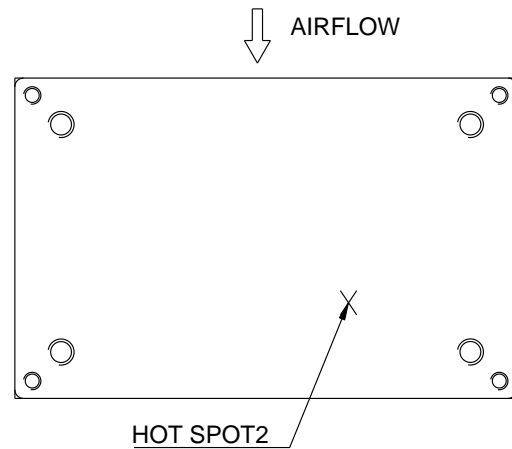

Figure 23: * Hot spot2 temperature measured point. The allowed maximum hot spot2 temperature is defined at 108°C.

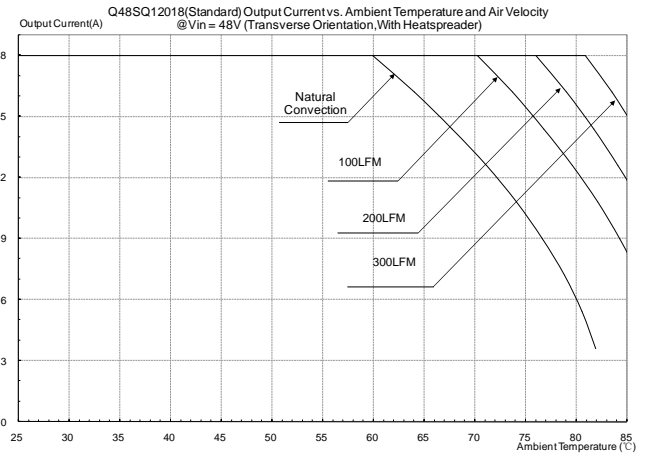
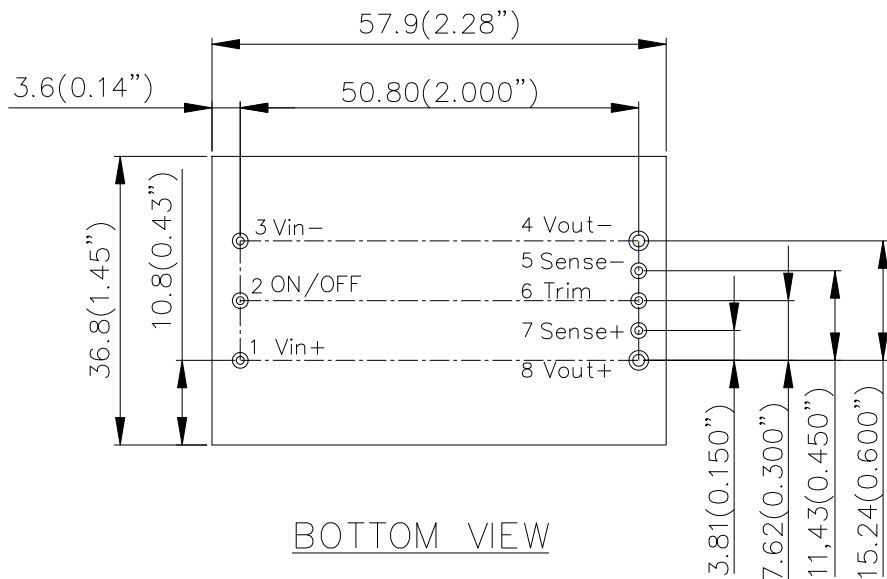
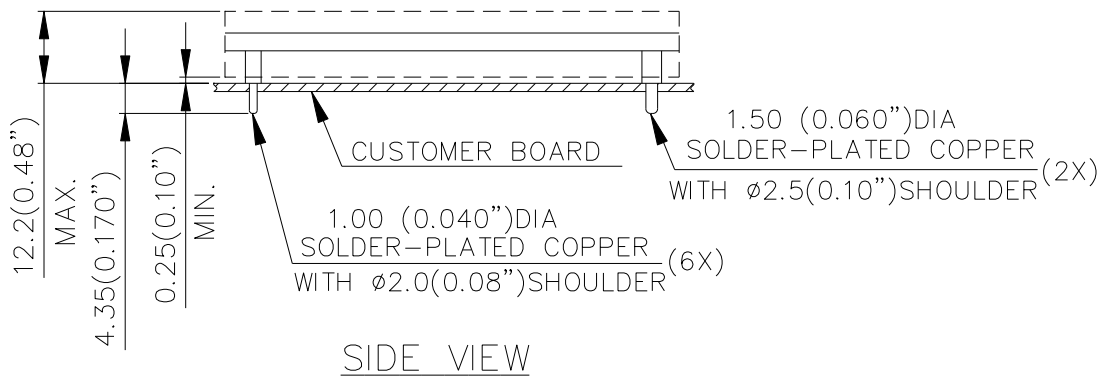
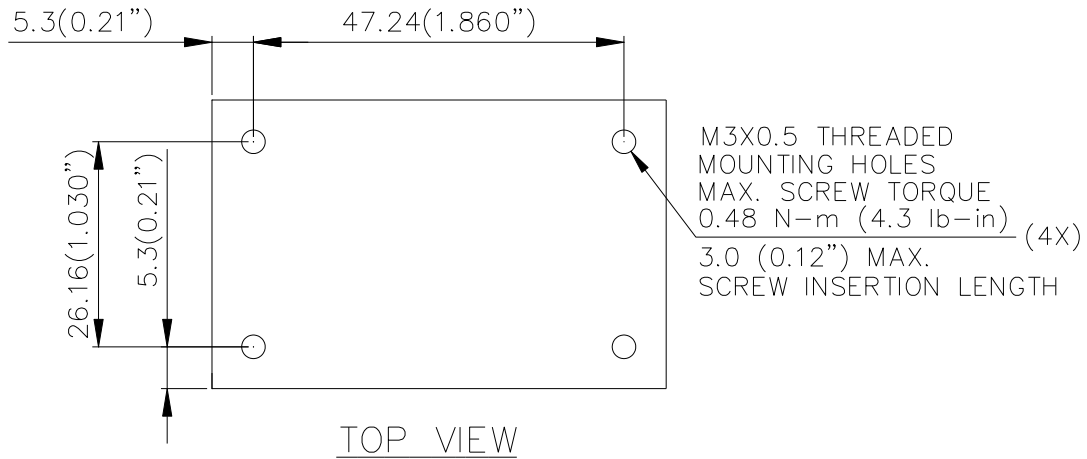

Figure 24: Output current vs. ambient temperature and air velocity @Vin=48V(Transverse Orientation, airflow from Vin+ to Vin-, with heat spreader)

MECHANICAL DRAWING (WITH HEAT SPREADER)

* For modules with through-hole pins and the optional heatspreader, they are intended for wave soldering assembly onto system boards; please do not subject such modules through reflow temperature profile.



NOTES:
DIMENSIONS ARE IN MILLIMETERS AND (INCHES)
TOLERANCES: X.Xmm \pm 0.5mm(X.XX in. \pm 0.02 in.)
X.XXmm \pm 0.25mm(X.XXX in. \pm 0.010 in.)

MECHANICAL DRAWING (WITHOUT HEAT SPREADER)

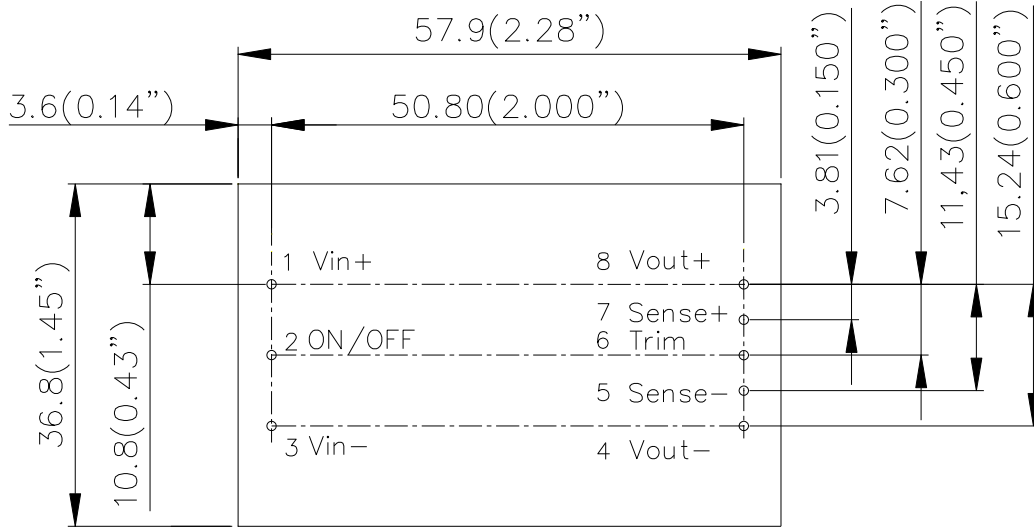

TOP VIEW

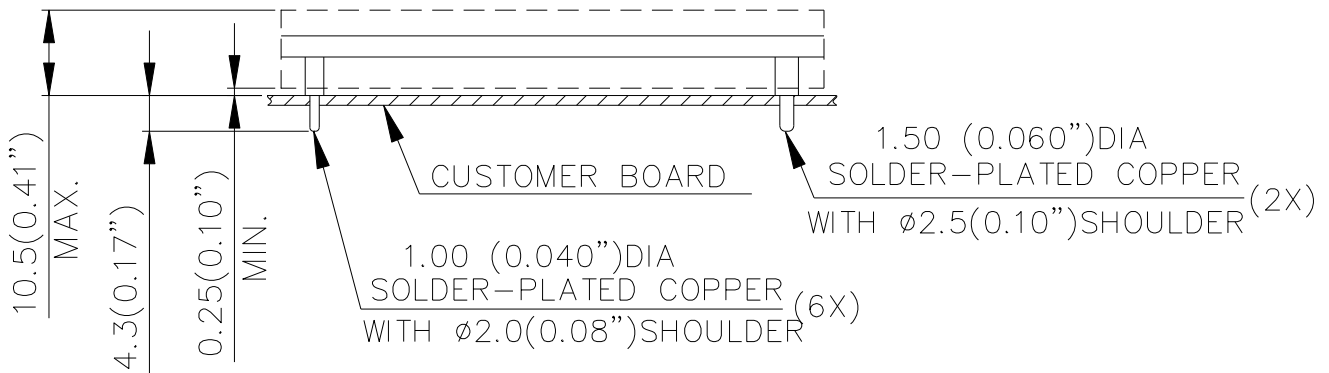

SIDE VIEW

NOTES:

DIMENSIONS ARE IN MILLIMETERS AND (INCHES)

TOLERANCES: X.Xmm±0.5mm(X.XX in.±0.02 in.)

X.XXmm±0.25mm(X.XXX in.±0.010 in.)

Pin No.	Name	Function
1	+Vin	Positive input voltage
2	ON/OFF	Remote ON/OFF
3	-Vin	Negative input voltage
4	-Vout	Negative output voltage
5	-Sense	Negative remote sense
6	Trim	Output voltage trim
7	+Sense	Positive remote sense
8	+Vout	Positive output voltage

Pin Specification:

Pins 1-3,5~7 1.00mm (0.040") diameter
Pins 4,8 1.50mm (0.060") diameter

All pins are copper alloy with matte Tin plated(Pb free) and Nickel under plating.

RECOMMENDED LAYOUT

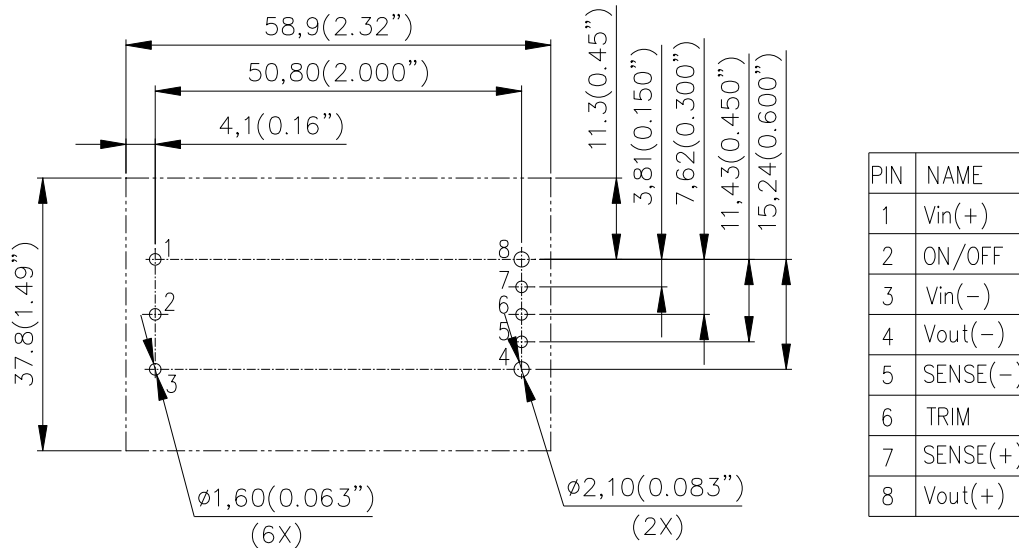

PART NUMBERING SYSTEM

Q	48	S	Q	120	18	N	R	F	H
Form Factor	Input Voltage	Number of Outputs	Product Series	Output Voltage	Output Current	ON/OFF Logic	Pin Length		
Q - Quarter Brick	48-36V~75V	S - Single	Q- QB high power series	120 - 12V	18 - 18A	N - Negative P - Positive	K - 0.110" N - 0.146" R - 0.170"	F - RoHS 6/6 (Lead Free) Space - RoHS5/6	A - with trim/ sense pin no heat spreader B - no trim/sense pin no heat spreader H - with trim/sense pin with heat spreader N - no trim/sense pin with heat spreader

*** For modules with through-hole pins and the optional heatspreader, they are intended for wave soldering assembly onto system boards; please do not subject such modules through reflow temperature profile.**

CONTACT: www.deltaww.com/dcdc

USA:

Telephone:
East Coast: 978-656-3993
West Coast: 510-668-5100
Fax: (978) 656 3964
Email: DCDC@delta-corp.com

Europe:

Phone: +31-20-655-0967
Fax: +31-20-655-0999
Email: DCDC@delta-es.com

Asia & the rest of world:

Telephone: +886 3 4526107
ext 6220~6224
Fax: +886 3 4513485
Email: DCDC@delta.com.tw

WARRANTY

Delta offers a two (2) year limited warranty. Complete warranty information is listed on our web site or is available upon request from Delta.

Information furnished by Delta is believed to be accurate and reliable. However, no responsibility is assumed by Delta for its use, nor for any infringements of patents or other rights of third parties, which may result from its use. No license is granted by implication or otherwise under any patent or patent rights of Delta. Delta reserves the right to revise these specifications at any time, without notice.