

MAC08BT1, MAC08MT1

Preferred Device

Sensitive Gate Triacs

Silicon Bidirectional Thyristors

Designed for use in solid state relays, MPU interface, TTL logic and other light industrial or consumer applications. Supplied in surface mount package for use in automated manufacturing.

Features

- Sensitive Gate Trigger Current in Four Trigger Modes
- Blocking Voltage to 600 Volts
- Glass Passivated Surface for Reliability and Uniformity
- Surface Mount Package
- Pb-Free Packages are Available

MAXIMUM RATINGS ($T_J = 25^\circ\text{C}$ unless otherwise noted)

Rating	Symbol	Value	Unit
Peak Repetitive Off-State Voltage (Note 1) (Sine Wave, 50 to 60 Hz, Gate Open, $T_J = 25$ to 110°C) MAC08BT1 MAC08MT1	V_{DRM} , V_{RRM}	200 600	V
On-State Current RMS ($T_C = 80^\circ\text{C}$) (Full Sine Wave 50 to 60 Hz)	$I_{T(RMS)}$	0.8	A
Peak Non-repetitive Surge Current (One Full Cycle Sine Wave, 60 Hz, $T_C = 25^\circ\text{C}$)	I_{TSM}	8.0	A
Circuit Fusing Considerations (Pulse Width = 8.3 ms)	I^2t	0.4	A^2s
Peak Gate Power ($T_C = 80^\circ\text{C}$, Pulse Width $\leq 1.0 \mu\text{s}$)	P_{GM}	5.0	W
Average Gate Power ($T_C = 80^\circ\text{C}$, $t = 8.3$ ms)	$P_{G(AV)}$	0.1	W
Operating Junction Temperature Range	T_J	-40 to +110	$^\circ\text{C}$
Storage Temperature Range	T_{stg}	-40 to +150	$^\circ\text{C}$

Maximum ratings are those values beyond which device damage can occur. Maximum ratings applied to the device are individual stress limit values (not normal operating conditions) and are not valid simultaneously. If these limits are exceeded, device functional operation is not implied, damage may occur and reliability may be affected.

1. V_{DRM} and V_{RRM} for all types can be applied on a continuous basis. Blocking voltages shall not be tested with a constant current source such that the voltage ratings of the devices are exceeded.

THERMAL CHARACTERISTICS

Characteristic	Symbol	Max	Unit
Thermal Resistance, Junction-to-Ambient PCB Mounted per Figure 1	$R_{\theta JA}$	156	$^\circ\text{C/W}$
Thermal Resistance, Junction-to-Tab Measured on MT2 Tab Adjacent to Epoxy	$R_{\theta JT}$	25	$^\circ\text{C/W}$
Maximum Device Temperature for Soldering Purposes for 10 Secs Maximum	T_L	260	$^\circ\text{C}$



Expertise Applied | Answers Delivered

Littelfuse.com

TRIAC
0.8 AMPERE RMS
200 thru 600 VOLTS

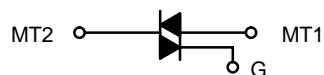

MARKING DIAGRAM

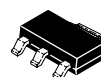

SOT-223
CASE 318E
STYLE 11

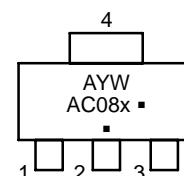

A = Assembly Location
Y = Year
W = Work Week
AC08X = Device Code
x = B or M
▪ = Pb-Free Package
(Note: Microdot may be in either location)

PIN ASSIGNMENT

1	Main Terminal 1
2	Main Terminal 2
3	Gate
4	Main Terminal 2

ORDERING INFORMATION

Device	Package	Shipping
MAC08BT1	SOT-223	1000 Tape & Reel
MAC08BT1G	SOT-223 (Pb-Free)	1000 Tape & Reel
MAC08MT1	SOT-223	1000 Tape & Reel
MAC08MT1G	SOT-223 (Pb-Free)	1000 Tape & Reel

Preferred devices are recommended choices for future use and best overall value.

MAC08BT1, MAC08MT1

ELECTRICAL CHARACTERISTICS ($T_C = 25^\circ\text{C}$ unless otherwise noted; Electricals apply in both directions.)

Characteristic	Symbol	Min	Typ	Max	Unit
----------------	--------	-----	-----	-----	------

OFF CHARACTERISTICS

Peak Repetitive Blocking Current ($V_D = \text{Rated } V_{DRM}, V_{RRM}; \text{ Gate Open}$)	I_{DRM}, I_{RRM}	-	-	10 200	μA μA
					$T_J = 25^\circ\text{C}$ $T_J = 110^\circ\text{C}$

ON CHARACTERISTICS

Peak On-State Voltage (Note 2) ($I_T = \pm 1.1 \text{ A Peak}$)	V_{TM}	-	-	1.9	V
Gate Trigger Current (Continuous dc) All Quadrants ($V_D = 12 \text{ Vdc}, R_L = 100 \Omega$)	I_{GT}	-	-	10	mA
Holding Current (Continuous dc) ($V_D = 12 \text{ Vdc}, \text{ Gate Open}, \text{ Initiating Current} = \pm 20 \text{ mA}$)	I_H	-	-	5.0	mA
Gate Trigger Voltage (Continuous dc) All Quadrants ($V_D = 12 \text{ Vdc}, R_L = 100 \Omega$)	V_{GT}	-	-	2.0	V

DYNAMIC CHARACTERISTICS

Critical Rate of Rise of Commutation Voltage ($f = 250 \text{ Hz}, I_{TM} = 1.0 \text{ A}, \text{ Commutating } di/dt = 1.5 \text{ A/mS}$ On-State Current Duration = 2.0 mS, $V_{DRM} = 200 \text{ V}$, Gate Unenergized, $T_C = 110^\circ\text{C}$, Gate Source Resistance = 150 Ω , See Figure 10)	$(dv/dt)_c$	1.5	-	-	V/ μs
Critical Rate-of-Rise of Off State Voltage ($V_{pk} = \text{Rated } V_{DRM}, T_C = 110^\circ\text{C}, \text{ Gate Open}, \text{ Exponential Method}$)	dv/dt	10	-	-	V/ μs

2. Pulse Test: Pulse Width $\leq 300 \mu\text{sec}$, Duty Cycle $\leq 2\%$.

Voltage Current Characteristic of Triacs (Bidirectional Device)

Symbol	Parameter
V_{DRM}	Peak Repetitive Forward Off State Voltage
I_{DRM}	Peak Forward Blocking Current
V_{RRM}	Peak Repetitive Reverse Off State Voltage
I_{RRM}	Peak Reverse Blocking Current
V_{TM}	Maximum On State Voltage
I_H	Holding Current

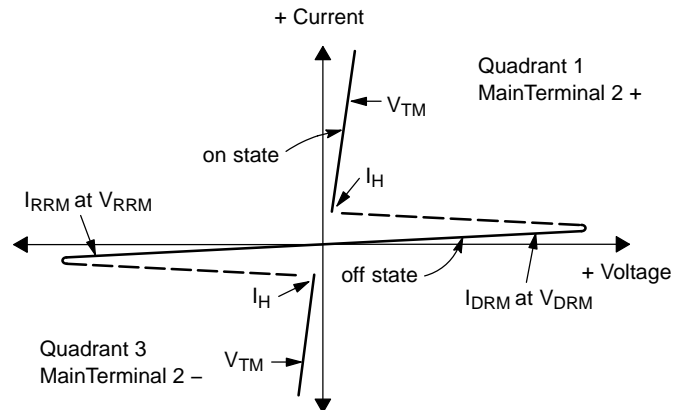

MAC08BT1, MAC08MT1

Quadrant Definitions for a Triac

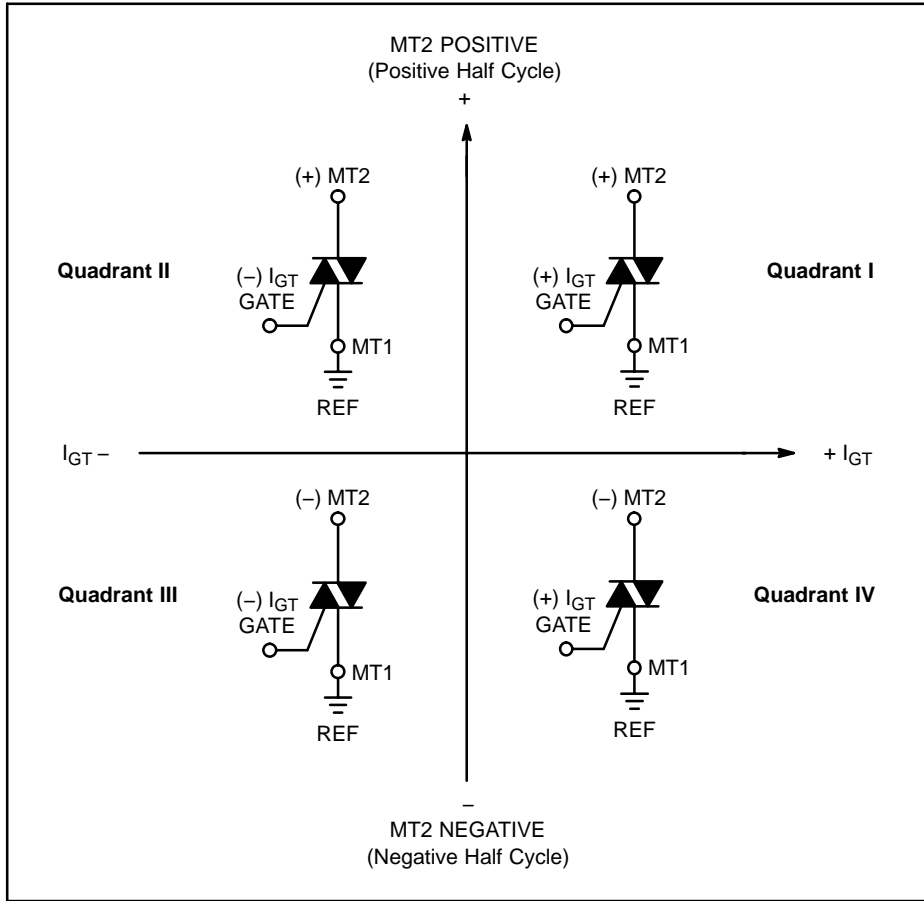

All polarities are referenced to MT1.
With in-phase signals (using standard AC lines) quadrants I and III are used.

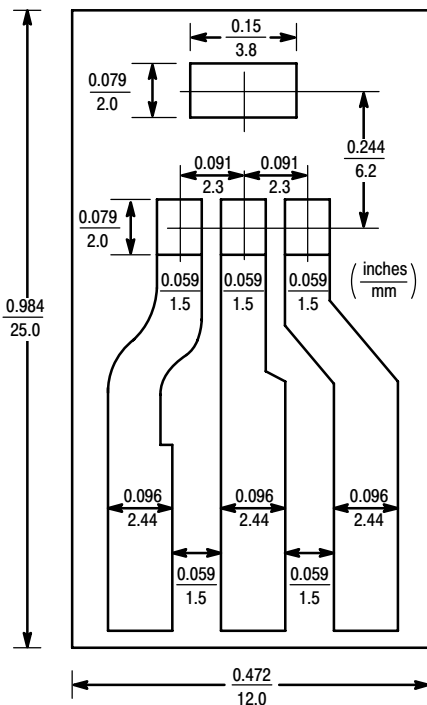

BOARD MOUNTED VERTICALLY IN CINCH 8840 EDGE CONNECTOR.
BOARD THICKNESS = 65 MIL., FOIL THICKNESS = 2.5 MIL.
MATERIAL: G10 FIBERGLASS BASE EPOXY

Figure 1. PCB for Thermal Impedance and Power Testing of SOT-223

MAC08BT1, MAC08MT1

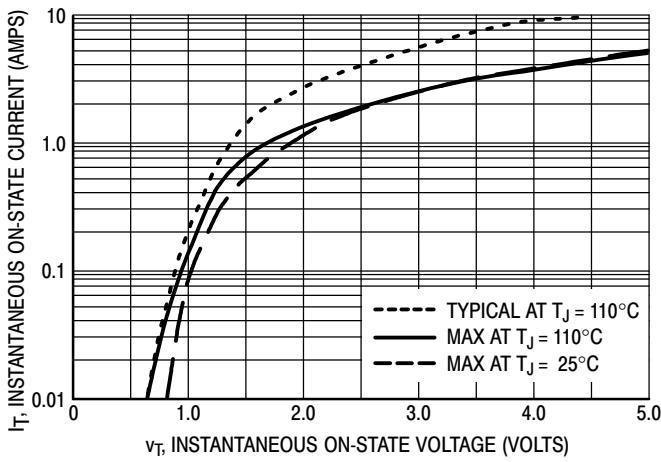

Figure 2. On-State Characteristics

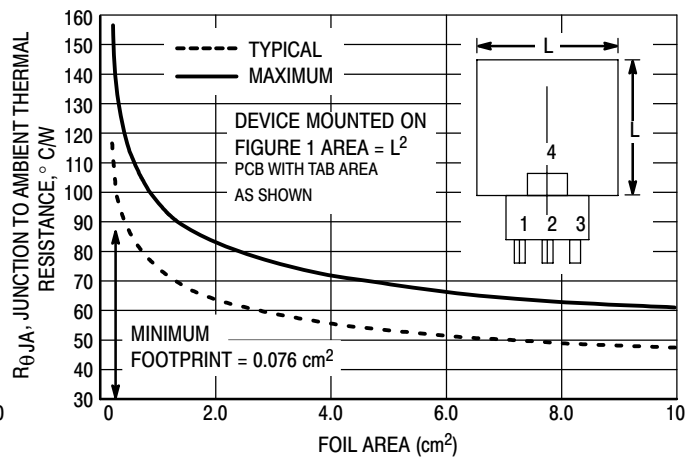

Figure 3. Junction to Ambient Thermal Resistance versus Copper Tab Area

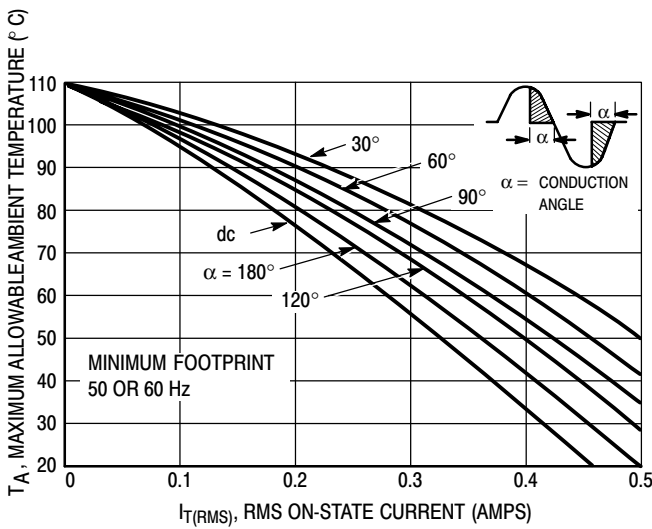

Figure 4. Current Derating, Minimum Pad Size Reference: Ambient Temperature

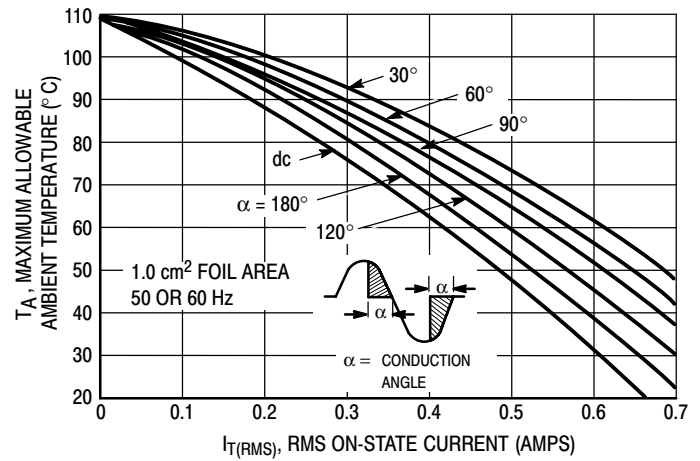

Figure 5. Current Derating, 1.0 cm Square Pad Reference: Ambient Temperature

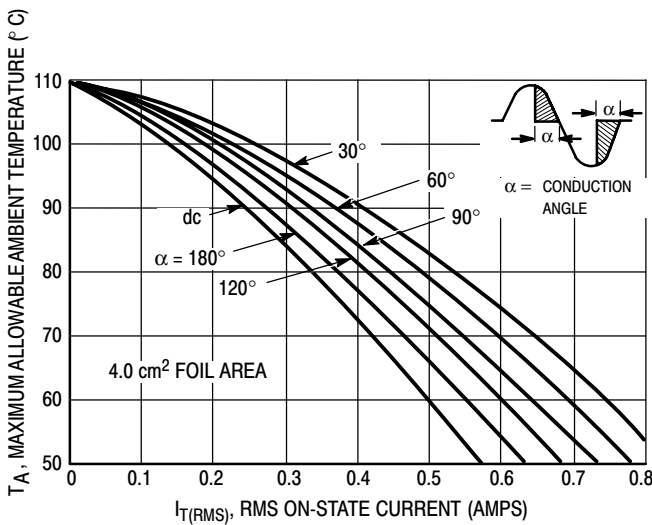

Figure 6. Current Derating, 2.0 cm Square Pad Reference: Ambient Temperature

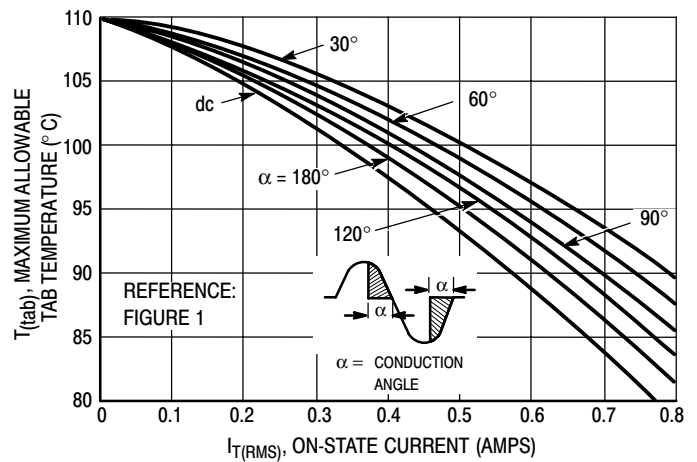

Figure 7. Current Derating Reference: MT2 Tab

MAC08BT1, MAC08MT1

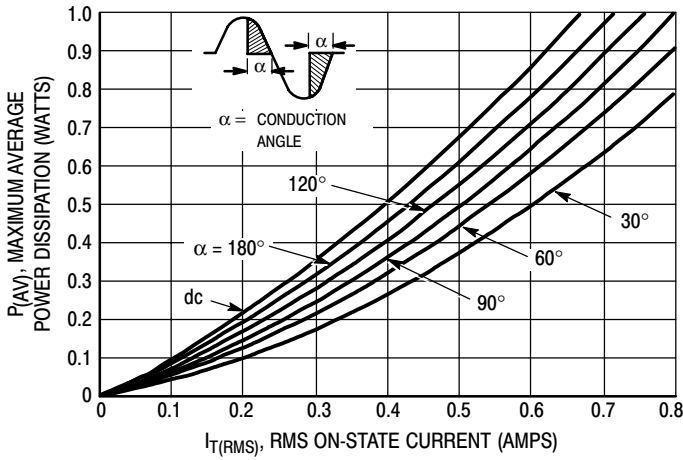

Figure 8. Power Dissipation

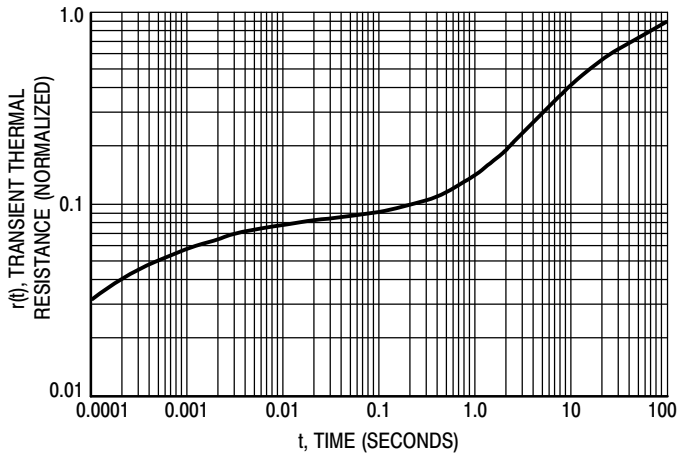
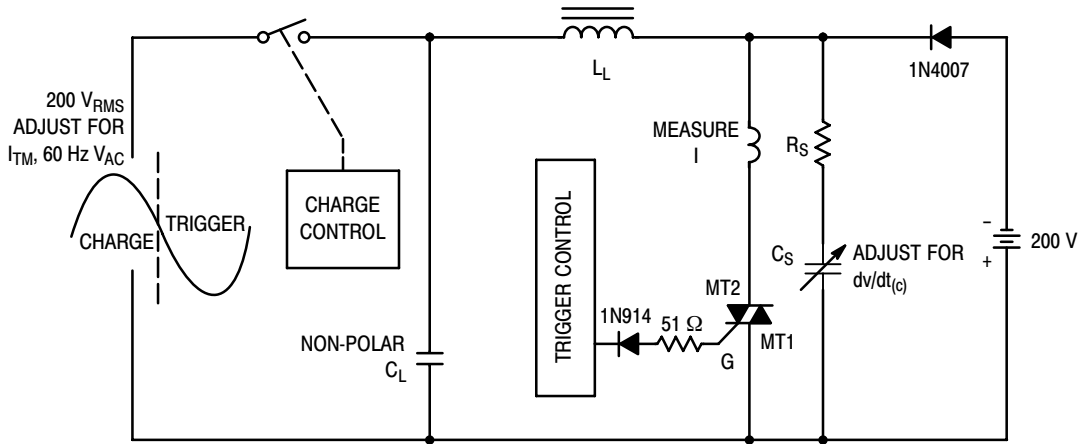

Figure 9. Thermal Response, Device Mounted on Figure 1 Printed Circuit Board



Note: Component values are for verification of rated $(dv/dt)_c$. See AN1048 for additional information.

Figure 10. Simplified Test Circuit to Measure the Critical Rate of Rise of Commutating Voltage $(dv/dt)_c$

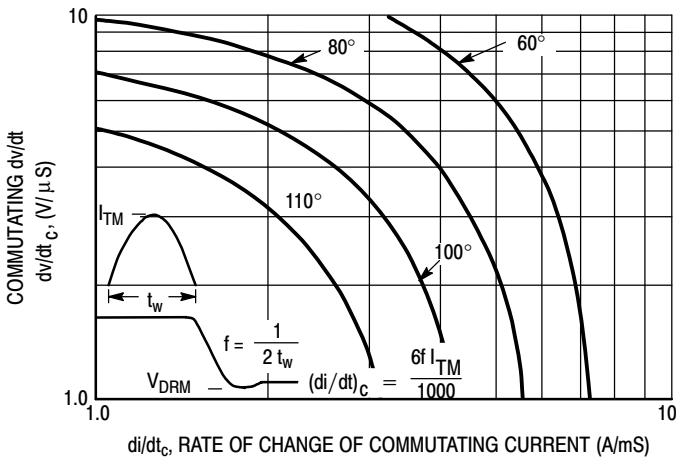

Figure 11. Typical Commutating dv/dt versus Current Crossing Rate and Junction Temperature

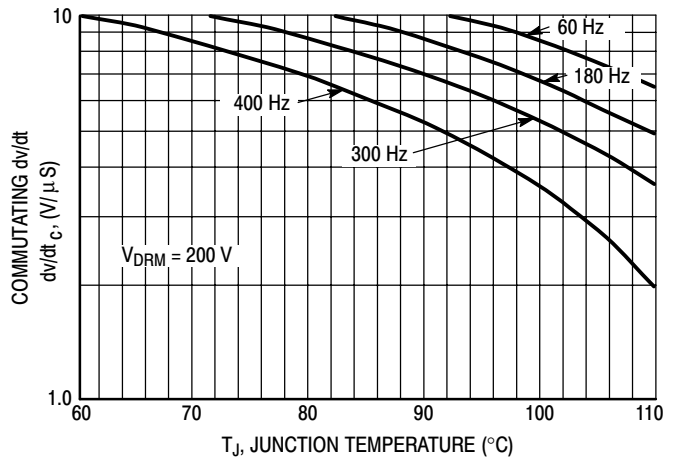

Figure 12. Typical Commutating dv/dt versus Junction Temperature at 0.8 Amps RMS

MAC08BT1, MAC08MT1

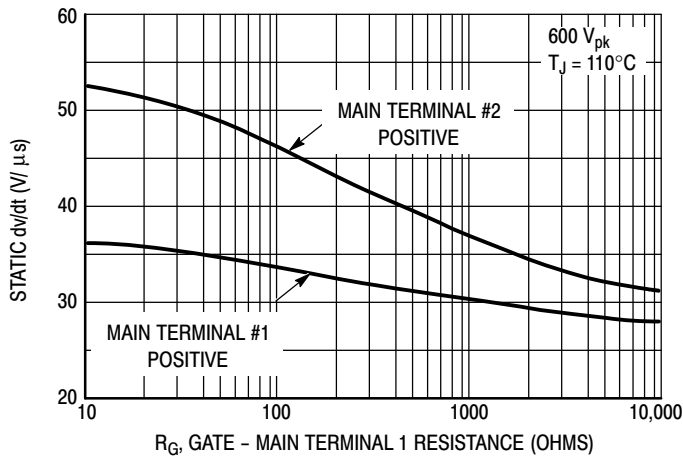

Figure 13. Exponential Static dv/dt versus Gate - Main Terminal 1 Resistance

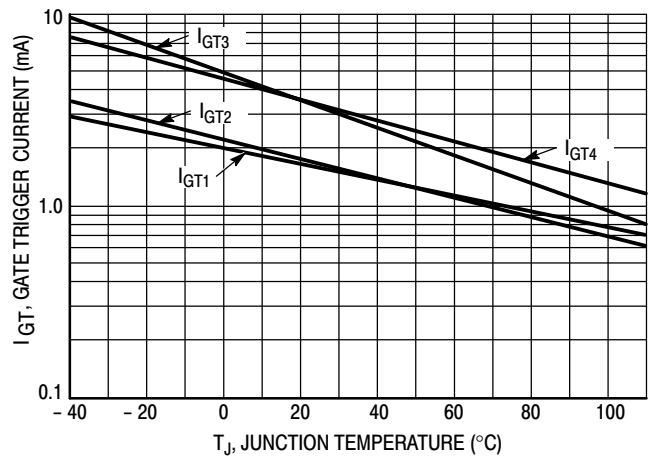

Figure 14. Typical Gate Trigger Current Variation

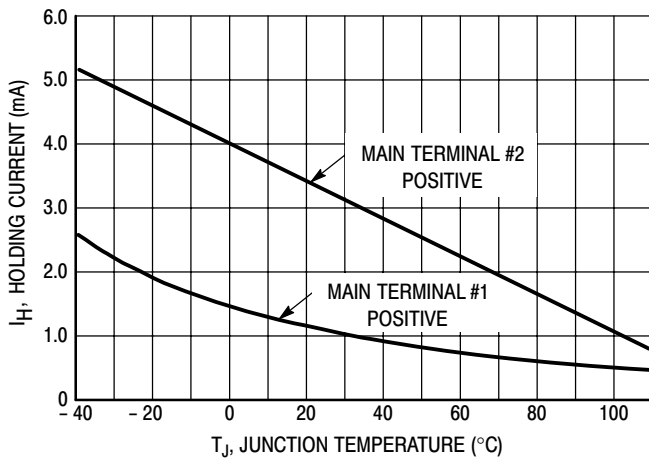

Figure 15. Typical Holding Current Variation

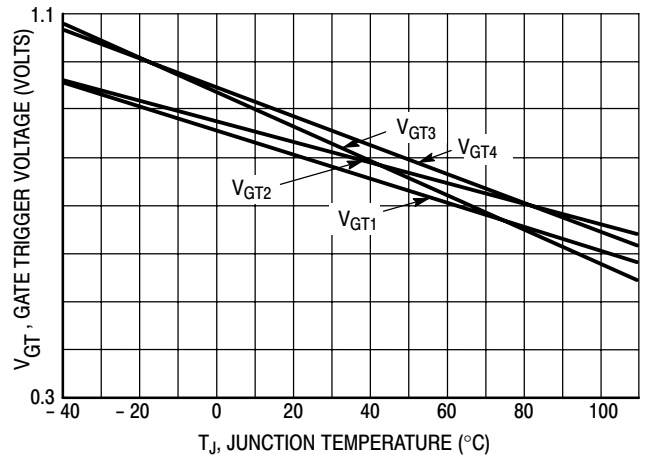
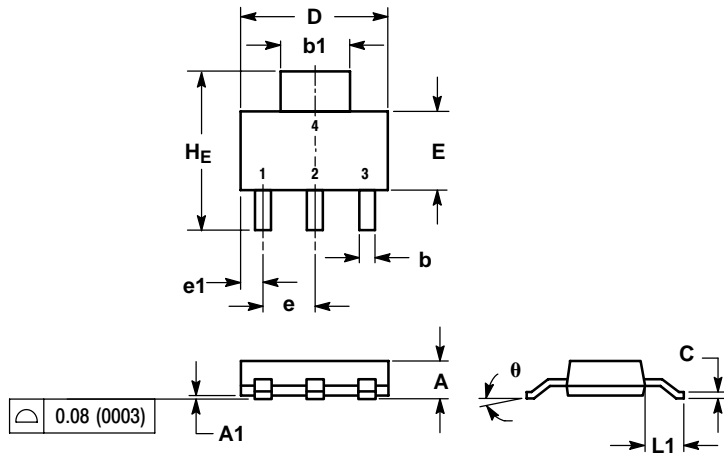

Figure 16. Gate Trigger Voltage Variation

MAC08BT1, MAC08MT1

PACKAGE DIMENSIONS

SOT-223 (TO-261)
CASE 318E-04
ISSUE L



- NOTES:
1. DIMENSIONING AND TOLERANCING PER ANSI Y14.5M, 1982.
2. CONTROLLING DIMENSION: INCH.

DIM	MILLIMETERS			INCHES		
	MIN	NOM	MAX	MIN	NOM	MAX
A	1.50	1.63	1.75	0.060	0.064	0.068
A1	0.02	0.06	0.10	0.001	0.002	0.004
b	0.60	0.75	0.89	0.024	0.030	0.035
b1	2.90	3.06	3.20	0.115	0.121	0.126
c	0.24	0.29	0.35	0.009	0.012	0.014
D	6.30	6.50	6.70	0.249	0.256	0.263
E	3.30	3.50	3.70	0.130	0.138	0.145
e	2.20	2.30	2.40	0.087	0.091	0.094
e1	0.85	0.94	1.05	0.033	0.037	0.041
L1	1.50	1.75	2.00	0.060	0.069	0.078
HE	6.70	7.00	7.30	0.264	0.276	0.287
θ	0°	-	10°	0°	-	10°

- STYLE 11:
PIN 1. MT 1
2. MT 2
3. GATE
4. MT 2

SOLDERING FOOTPRINT

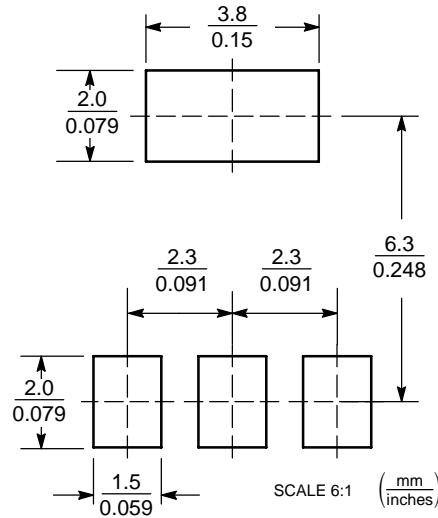

Littelfuse products are not designed for, and shall not be used for, any purpose (including, without limitation, automotive, military, aerospace, medical, life-saving, life-sustaining or nuclear facility applications, devices intended for surgical implant into the body, or any other application in which the failure or lack of desired operation of the product may result in personal injury, death, or property damage) other than those expressly set forth in applicable Littelfuse product documentation. Warranties granted by Littelfuse shall be deemed void for products used for any purpose not expressly set forth in applicable Littelfuse documentation. Littelfuse shall not be liable for any claims or damages arising out of products used in applications not expressly intended by Littelfuse as set forth in applicable Littelfuse documentation. The sale and use of Littelfuse products is subject to Littelfuse Terms and Conditions of Sale, unless otherwise agreed by Littelfuse.

Littelfuse.com