

Features and Benefits

- Epitaxial Planar Die Construction
- Two Pre-Biased Transistors and Two Switching Diodes, Internally Connected in One Package
- Ideally Suited for Automated Assembly Processes
- **Lead Free By Design/RoHS Compliant (Note 1)**
- **"Green" Device (Note 2)**
- **Qualified to AEC-Q101 standards for High Reliability**

R1 = R3 = 2.2kΩ (nominal)

R2 = R4 = 47kΩ (nominal)

Mechanical Data

- Case: SOT-363
- Case Material: Molded Plastic. "Green" Molding Compound. UL Flammability Classification Rating 94V-0
- Moisture Sensitivity: Level 1 per J-STD-020
- Terminal Connections: See Diagram
- Terminals: Finish - Matte Tin annealed over Alloy 42 leadframe. Solderable per MIL-STD-202, Method 208
- Weight: 0.0062 grams (approximate)



Top View

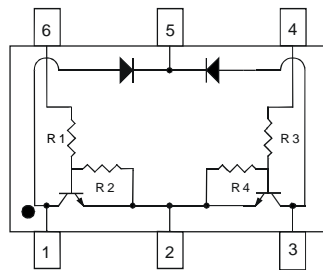

Top View

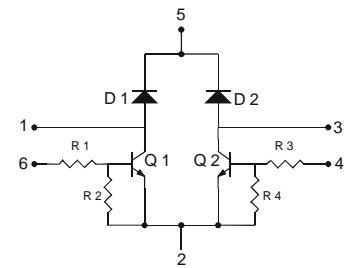

Device Circuit

Ordering Information (Note 3)

Device	Packaging	Shipping
DRDNB21D-7	SOT-363	3000/Tape & Reel

- Notes:
1. No purposefully added lead.
 2. Diodes Inc.'s "Green" Policy can be found on our website at <http://www.diodes.com>
 3. For packaging details, visit our website at <http://www.diodes.com>.

Marking Information

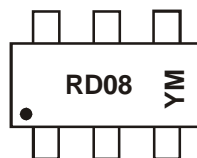

RD08 = Product Type Marking Code
 YM = Date Code Marking
 Y = Year (e.g. T = 2006)
 M = Month (e.g. 1 = January)

Date Code Key

Year	2005	2006	2007	2008	2009	2010	2011	2012	2013	2014	2015	2016
Code	S	T	U	V	W	X	Y	Z	A	B	C	D
Month	Jan	Feb	Mar	Apr	May	Jun	Jul	Aug	Sep	Oct	Nov	Dec
Code	1	2	3	4	5	6	7	8	9	O	N	D

Maximum Ratings, Total Device @T_A = 25°C unless otherwise specified

Characteristic	Symbol	Value	Unit
Power Dissipation (Note 4)	P _D	200	mW
Thermal Resistance, Junction to Ambient Air (Note 4)	R _{θJA}	625	°C/W
Operating and Storage Junction Temperature Range	T _J , T _{STG}	-55 to +150	°C

Maximum Ratings, Pre-Biased NPN Transistor @T_A = 25°C unless otherwise specified

Characteristic	Symbol	Value	Unit
Collector-Emitter Voltage	V _{CC}	50	V
Base-Emitter Voltage	V _{in}	-5 to +12	V
Output Current	I _O	100	mA
Peak Collector Current	I _{CM}	100	mA

Maximum Ratings, Switching Diode @T_A = 25°C unless otherwise specified

Characteristic	Symbol	Value	Unit
Non-Repetitive Peak Reverse Voltage	V _{RM}	100	V
Peak Repetitive Reverse Voltage	V _{RPM}	75	V
Working Peak Reverse Voltage	V _{RWM}		
DC Blocking Voltage	V _R		
RMS Reverse Voltage	V _{R(RMS)}	53	V
Forward Continuous Current (Note 4)	I _{FM}	500	mA
Average Rectified Output Current (Note 4)	I _O	250	mA
Non-Repetitive Peak Forward Surge Current @ t = 1.0µs	I _{FSM}	4.0	A
@ t = 1.0s		1.0	

Electrical Characteristics, Pre-Biased NPN Transistor @T_A = 25°C unless otherwise specified

Characteristic	Symbol	Min	Typ	Max	Unit	Test Condition
Input Voltage	V _{I(off)}	0.5	—	—	V	V _{CC} = 5V, I _O = 100µA
	V _{I(on)}	—	—	1.1	V	V _O = 0.3V, I _O = 5mA
Output Voltage	V _{O(on)}	—	—	0.3	V	I _O /I _I = 50mA/0.25mA
Input Current	I _I	—	—	3.6	mA	V _I = 5V
Output Current	I _{O(off)}	—	—	0.5	µA	V _{CC} = 50V, V _I = 0V
DC Current Gain	G _I	80	—	—	—	V _O = 5V, I _O = 10mA
Input Resistor Tolerance	ΔR1	-30	—	+30	%	-
Resistance Ratio Tolerance	ΔR2/R1	-20	—	+20	%	-
Gain-Bandwidth Product*	f _T	—	250	—	MHz	V _{CE} = 10V, I _E = 5mA, f = 100MHz

* Transistor - For Reference Only

Electrical Characteristics, Switching Diode @T_A = 25°C unless otherwise specified

Characteristic	Symbol	Min	Max	Unit	Test Condition
Reverse Breakdown Voltage (Note 5)	V _{(BR)R}	75	—	V	I _R = 10µA
Forward Voltage	V _F	0.62	0.72	V	I _F = 5.0mA
		—	0.855		I _F = 10mA
		—	1.0		I _F = 100mA
		—	1.25		I _F = 150mA
Reverse Current (Note 5)	I _R	—	2.5	µA	V _R = 75V
			50	µA	V _R = 75V, T _J = 150°C
			30	µA	V _R = 25V, T _J = 150°C
			25	nA	V _R = 20V
Total Capacitance	C _T	—	4.0	pF	V _R = 0, f = 1.0MHz
Reverse Recovery Time	t _{rr}	—	4.0	ns	I _F = I _R = 10mA, I _{rr} = 0.1 x I _R , R _L = 100Ω

Notes: 4. Device mounted on FR-4 PCB, 1 inch x 0.85 inch x 0.062 inch; pad layout as shown on Diodes Inc. suggested pad layout document AP02001, which can be found on our website at <http://www.diodes.com>
5. Short duration pulse test used to minimize self-heating effect.

Device Characteristics

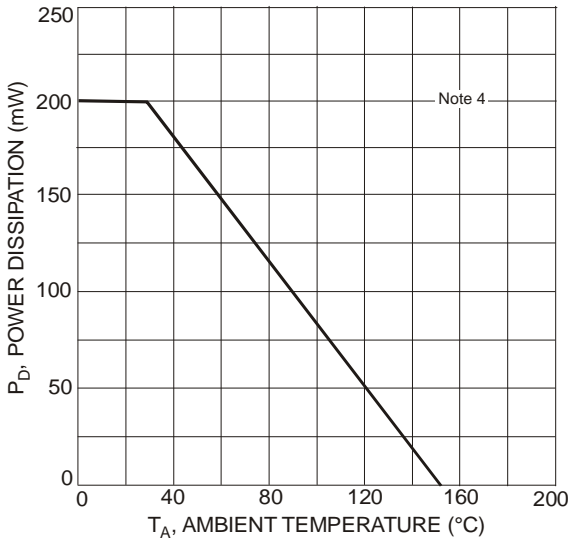

Fig. 1 Power Derating Curve (Total Device)

Pre-Biased NPN Transistor Elements

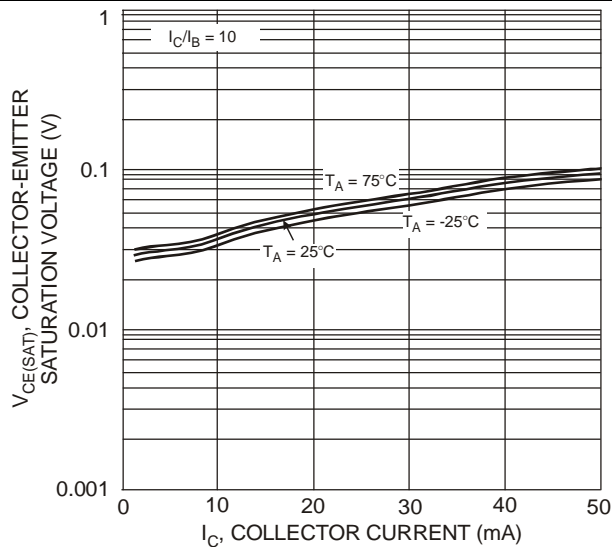

Fig. 2 Typical $V_{CE(SAT)}$ vs. I_C

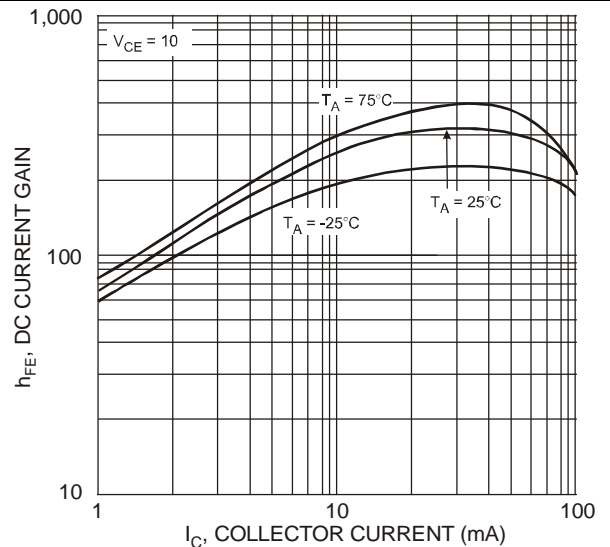

Fig. 3 Typical DC Current Gain

Pre-Biased NPN Transistor Elements - continued

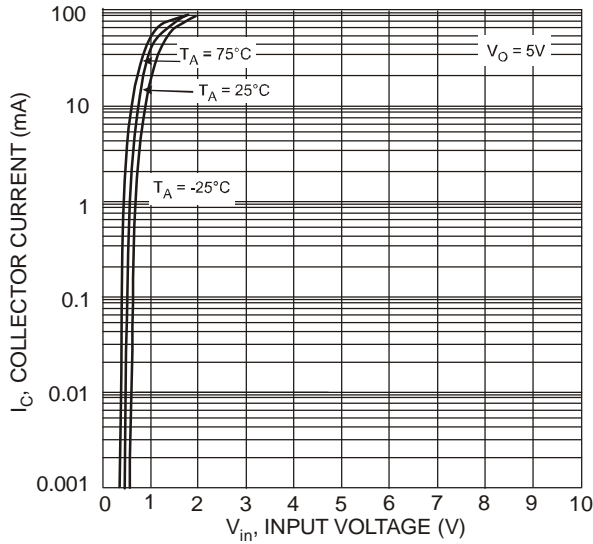

Fig. 4 Typical Collector Current vs. Input Voltage

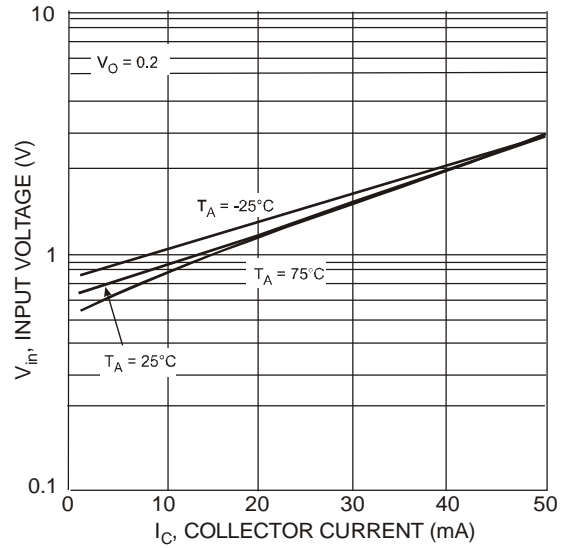

Fig. 5 Typical Input Voltage vs. Collector Current

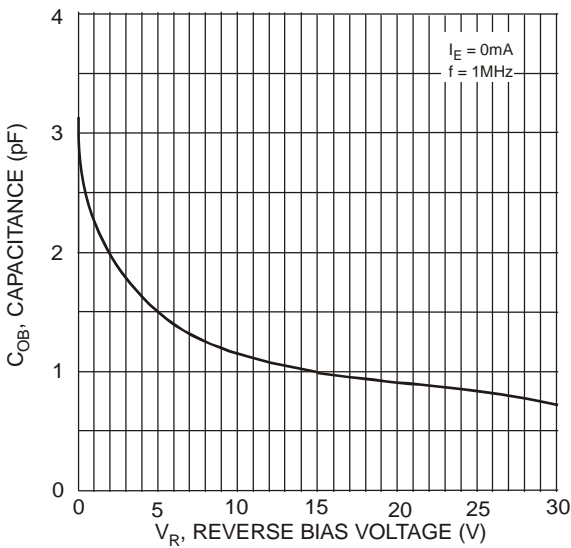

Fig. 6 Typical Output Capacitance

Switching Diode Elements

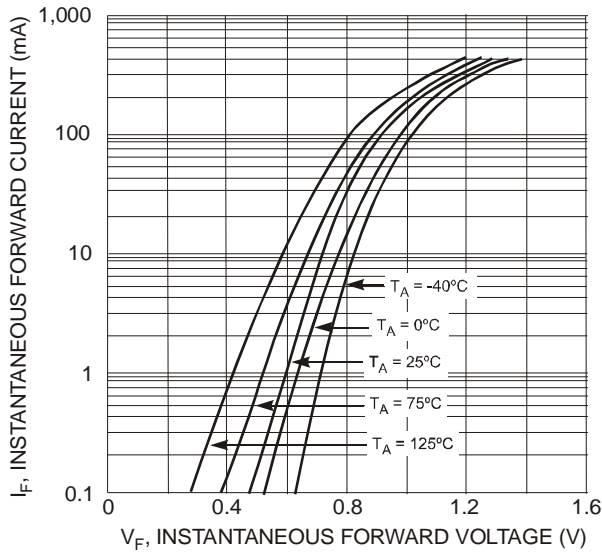

Fig. 7 Typical Forward Characteristics

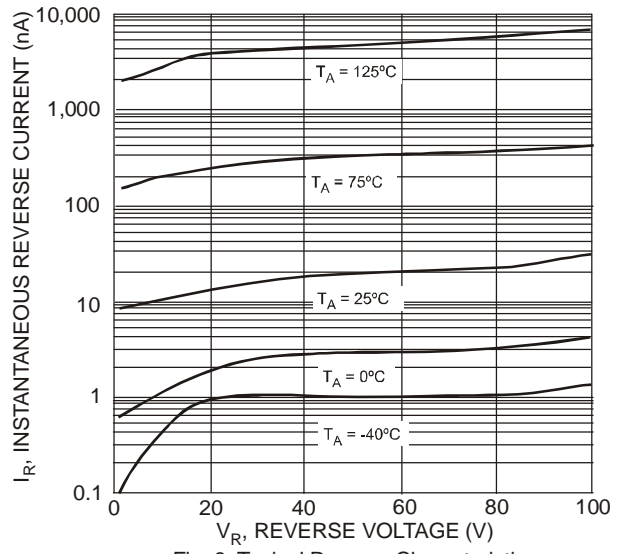

Fig. 8 Typical Reverse Characteristics

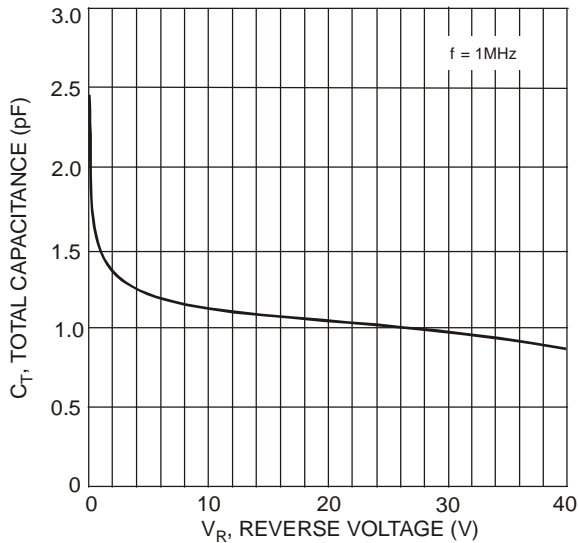
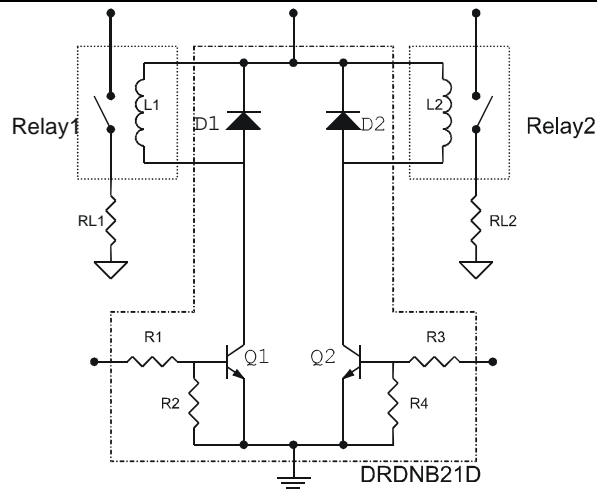

Fig. 9 Typical Capacitance vs. Reverse Voltage

Typical Application Circuit



Typical Application Circuit DRDNB21D with two independent relays.

Package Outline Dimensions

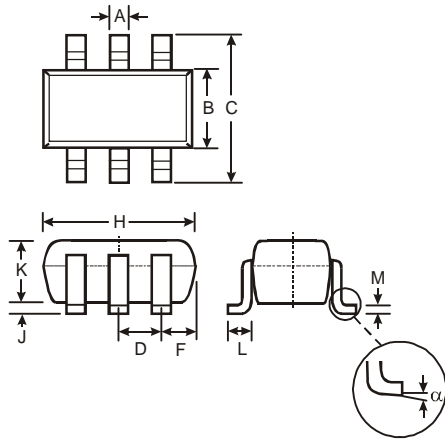

SOT-363		
Dim	Min	Max
A	0.10	0.30
B	1.15	1.35
C	2.00	2.20
D	0.65 Typ	
F	0.40	0.45
H	1.80	2.20
J	0	0.10
K	0.90	1.00
L	0.25	0.40
M	0.10	0.22
α	0°	8°
All Dimensions in mm		

Suggested Pad Layout

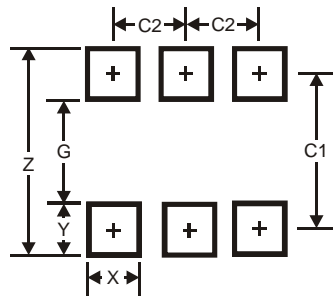

Dimensions	Value (in mm)
Z	2.5
G	1.3
X	0.42
Y	0.6
C1	1.9
C2	0.65

IMPORTANT NOTICE

DIODES INCORPORATED MAKES NO WARRANTY OF ANY KIND, EXPRESS OR IMPLIED, WITH REGARDS TO THIS DOCUMENT, INCLUDING, BUT NOT LIMITED TO, THE IMPLIED WARRANTIES OF MERCHANTABILITY AND FITNESS FOR A PARTICULAR PURPOSE (AND THEIR EQUIVALENTS UNDER THE LAWS OF ANY JURISDICTION).

Diodes Incorporated and its subsidiaries reserve the right to make modifications, enhancements, improvements, corrections or other changes without further notice to this document and any product described herein. Diodes Incorporated does not assume any liability arising out of the application or use of this document or any product described herein; neither does Diodes Incorporated convey any license under its patent or trademark rights, nor the rights of others. Any Customer or user of this document or products described herein in such applications shall assume all risks of such use and will agree to hold Diodes Incorporated and all the companies whose products are represented on Diodes Incorporated website, harmless against all damages.

Diodes Incorporated does not warrant or accept any liability whatsoever in respect of any products purchased through unauthorized sales channel. Should Customers purchase or use Diodes Incorporated products for any unintended or unauthorized application, Customers shall indemnify and hold Diodes Incorporated and its representatives harmless against all claims, damages, expenses, and attorney fees arising out of, directly or indirectly, any claim of personal injury or death associated with such unintended or unauthorized application.

Products described herein may be covered by one or more United States, international or foreign patents pending. Product names and markings noted herein may also be covered by one or more United States, international or foreign trademarks.

LIFE SUPPORT

Diodes Incorporated products are specifically not authorized for use as critical components in life support devices or systems without the express written approval of the Chief Executive Officer of Diodes Incorporated. As used herein:

A. Life support devices or systems are devices or systems which:

1. are intended to implant into the body, or
2. support or sustain life and whose failure to perform when properly used in accordance with instructions for use provided in the labeling can be reasonably expected to result in significant injury to the user.

B. A critical component is any component in a life support device or system whose failure to perform can be reasonably expected to cause the failure of the life support device or to affect its safety or effectiveness.

Customers represent that they have all necessary expertise in the safety and regulatory ramifications of their life support devices or systems, and acknowledge and agree that they are solely responsible for all legal, regulatory and safety-related requirements concerning their products and any use of Diodes Incorporated products in such safety-critical, life support devices or systems, notwithstanding any devices- or systems-related information or support that may be provided by Diodes Incorporated. Further, Customers must fully indemnify Diodes Incorporated and its representatives against any damages arising out of the use of Diodes Incorporated products in such safety-critical, life support devices or systems.

Copyright © 2011, Diodes Incorporated

www.diodes.com