

P-channel 30 V, 0.024 Ω typ., 6 A, STripFET™ VI DeepGATE™ Power MOSFET in a SO-8 package

Datasheet - preliminary data

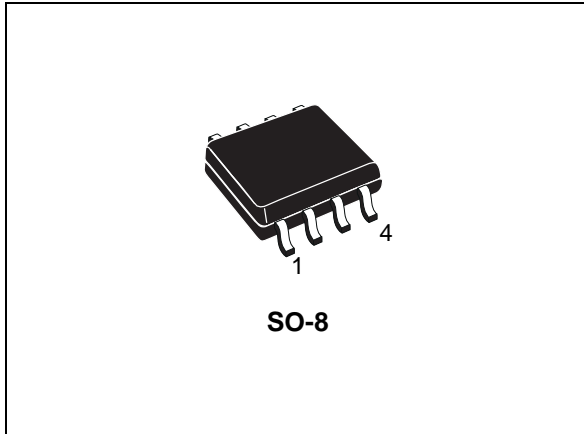
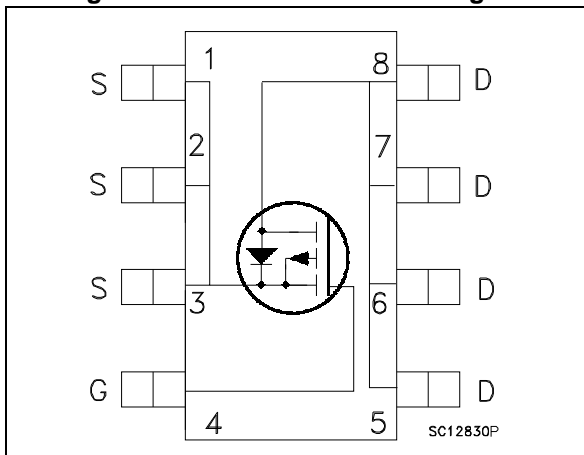

Figure 1. Internal schematic diagram



Features

Order code	V_{DS}	$R_{DS(on)}$ max	I_D
STS6P3LLH6	30 V	0.03 Ω	6 A

- $R_{DS(on)}$ * Q_g industry benchmark
- Extremely low on-resistance $R_{DS(on)}$
- High avalanche ruggedness

Applications

- Switching applications

Description

This device is an N-channel Power MOSFET developed using the 6th generation of STripFET™ DeepGATE™ technology, with a new gate structure. The resulting Power MOSFET exhibits the lowest $R_{DS(on)}$ in all packages.

Table 1. Device summary

Order code	Marking	Packages	Packaging
STS6P3LLH6	6K3L	SO-8	Tape and reel

Note: For the P-channel MOSFET actual polarity of voltages and current has to be reversed.

Contents

1	Electrical ratings	3
2	Electrical characteristics	4
2.1	Electrical characteristics (curves)	6
3	Test circuits	8
4	Package mechanical data	9
5	Packaging mechanical data	12
6	Revision history	14

1 Electrical ratings

Table 2. Absolute maximum ratings

Symbol	Parameter	Value	Unit
V_{DS}	Drain-source voltage	30	V
V_{GS}	Gate- source voltage	± 20	V
$I_D^{(1)}$	Drain current (continuous) at $T_{amb} = 25^\circ\text{C}$	6	A
$I_D^{(1)}$	Drain current (continuous) at $T_{amb} = 100^\circ\text{C}$	4	A
$I_{DM}^{(2)}$	Drain current (pulsed)	24	A
$P_{TOT}^{(1)}$	Total dissipation at $T_{amb} = 25^\circ\text{C}$	2.7	W
T_{stg}	Storage temperature	-55 to 150	$^\circ\text{C}$
T_j	Operating junction temperature	150	$^\circ\text{C}$

1. This value is rated according to $R_{thj-amb}$
2. Pulse width limited by safe operating area

Table 3. Thermal data

Symbol	Parameter	Value	Unit
$R_{thj-amb}^{(1)}$	Thermal resistance junction-amb	47	$^\circ\text{C/W}$

1. When mounted on 1 inch² FR-4 board, 2 oz. Cu., $t \leq 10$ sec

Note: For the P-channel MOSFET actual polarity of voltages and current has to be reversed.

2 Electrical characteristics

($T_{CASE} = 25\text{ °C}$ unless otherwise specified)

Table 4. On/off states

Symbol	Parameter	Test conditions	Min.	Typ.	Max.	Unit
$V_{(BR)DSS}$	Drain-source breakdown voltage	$I_D = 250\ \mu\text{A}$	30			V V
I_{DSS}	Zero gate voltage drain current ($V_{GS} = 0$)	$V_{DS} = 30\ \text{V}$			1	μA
		$V_{DS}=30\ \text{V}, T_C=125\text{ °C}$				
I_{GSS}	Gate-body leakage current ($V_{DS} = 0$)	$V_{GS} = \pm 20\ \text{V}$			± 100	nA
$V_{GS(th)}$	Gate threshold voltage	$V_{DS} = V_{GS}, I_D = 250\ \mu\text{A}$	1			V
$R_{DS(on)}$	Static drain-source on-resistance	$V_{GS} = 10\ \text{V}, I_D = 3\ \text{A}$		0.024	0.03	Ω
		$V_{GS} = 4.5\ \text{V}, I_D = 3\ \text{A}$		0.038	0.05	Ω

Table 5. Dynamic

Symbol	Parameter	Test conditions	Min.	Typ.	Max.	Unit
C_{iss}	Input capacitance	$V_{DS} = 24\ \text{V}, f = 1\ \text{MHz}, V_{GS} = 0$	-	1450	-	pF
C_{oss}	Output capacitance		-	178	-	pF
C_{rss}	Reverse transfer capacitance		-	120	-	pF
Q_g	Total gate charge	$V_{DD}=24\ \text{V}, I_D=6\ \text{A}, V_{GS}=4.5\ \text{V}$	-	12	-	nC
Q_{gs}	Gate-source charge		-	4.4	-	nC
Q_{gd}	Gate-drain charge		-	5	-	nC

Note: For the P-channel MOSFET actual polarity of voltages and current has to be reversed

Table 6. Switching times

Symbol	Parameter	Test conditions	Min.	Typ.	Max.	Unit
$t_{d(on)}$	Turn-on delay time	$V_{DD} = 24\ \text{V}, I_D = 3\ \text{A}, R_G=4.7\ \Omega, V_{GS} = 10\ \text{V}$ <i>Figure 13</i>	-	15	-	ns
t_r	Rise time		-	15	-	ns
$t_{d(off)}$	Turn-off delay time		-	24	-	ns
t_f	Fall time		-	21	-	ns

Note: For the P-channel MOSFET actual polarity of voltages and current has to be reversed

Table 7. Source drain diode

Symbol	Parameter	Test conditions	Min.	Typ.	Max.	Unit
I_{SD}	Source-drain current		-		6	A
$I_{SDM}^{(1)}$	Source-drain current (pulsed)		-		24	A
$V_{SD}^{(2)}$	Forward on voltage	$I_{SD} = 3A, V_{GS} = 0$	-		1.1	V
t_{rr}	Reverse recovery time	$I_{SD} = 3 A, di/dt = 100 A/\mu s$ $V_{DD} = 16 V, T_j = 150\text{ }^\circ\text{C}$	-	15		ns
Q_{rr}	Reverse recovery charge		-	6.5		nC
I_{RRM}	Reverse recovery current		-	0.9		A

1. Pulse width limited by safe operating area.

2. Pulsed: Pulse duration = 300 μs , duty cycle 1.5%

Note: For the P-channel MOSFET actual polarity of voltages and current has to be reversed

2.1 Electrical characteristics (curves)

Figure 2. Safe operating area

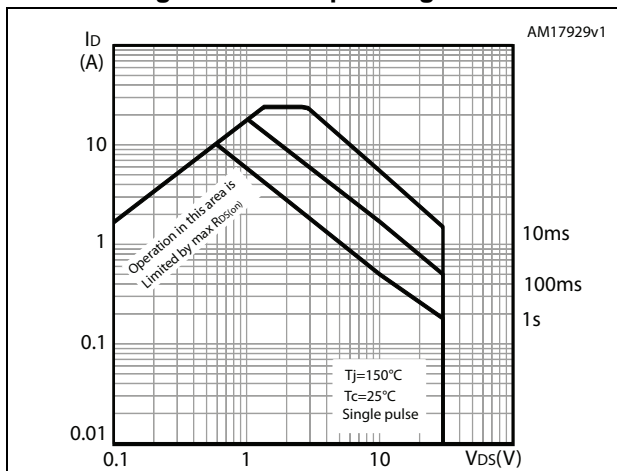

Figure 3. Thermal impedance

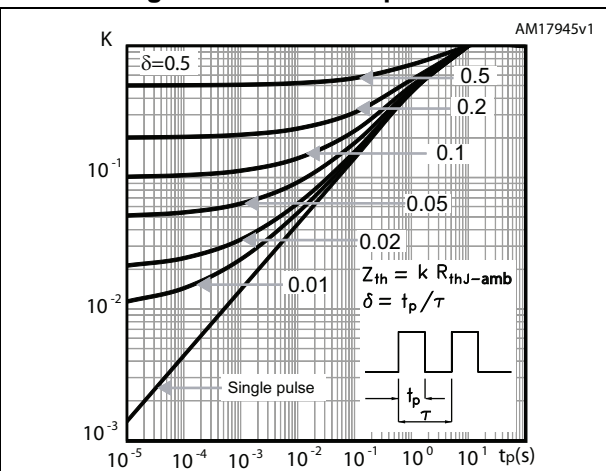

Figure 4. Output characteristics

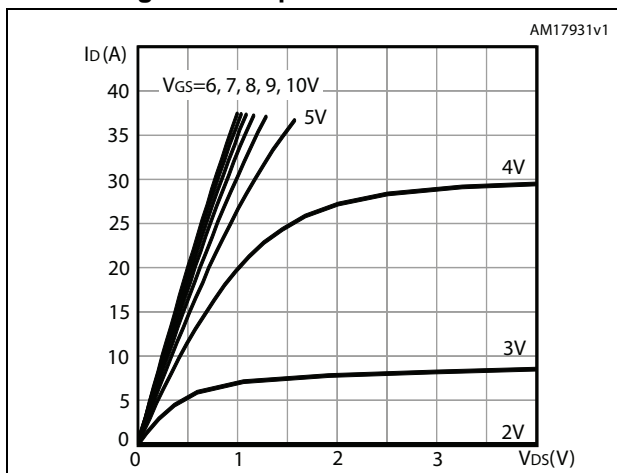

Figure 5. Transfer characteristics

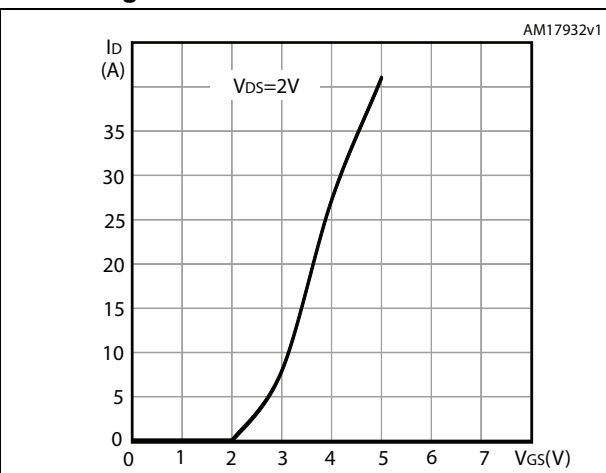

Figure 6. Gate charge vs gate-source voltage

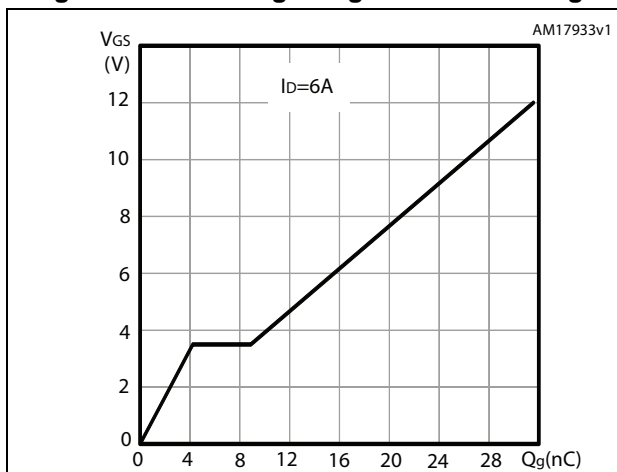

Figure 7. Static drain-source on-resistance

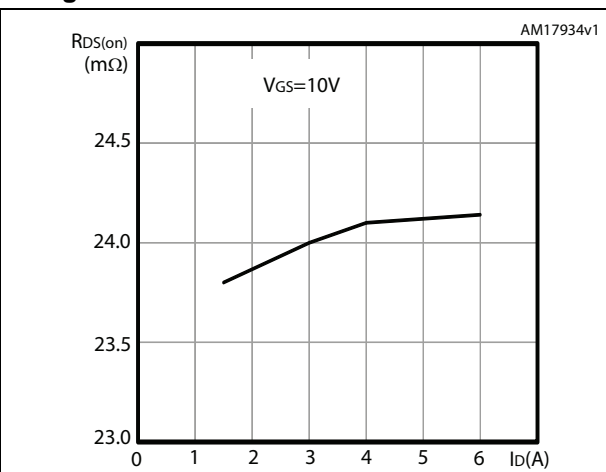

Figure 8. Capacitance variations

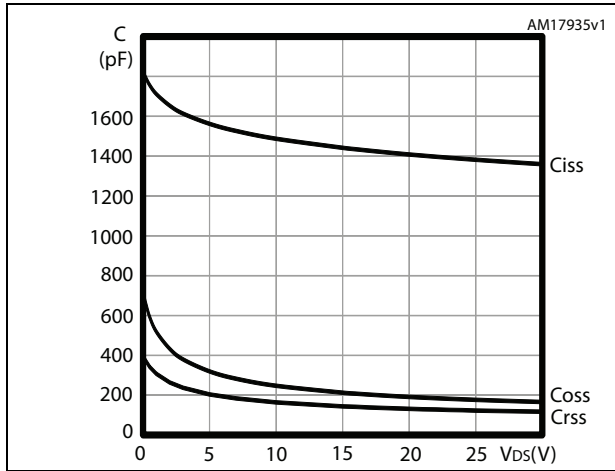

Figure 9. Normalized gate threshold voltage vs temperature

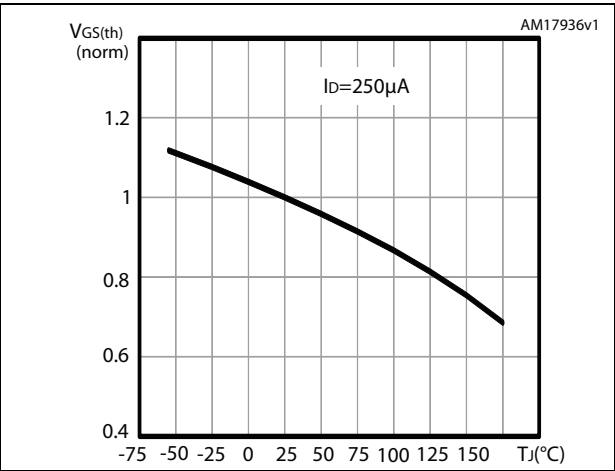

Figure 10. Normalized on-resistance vs temperature

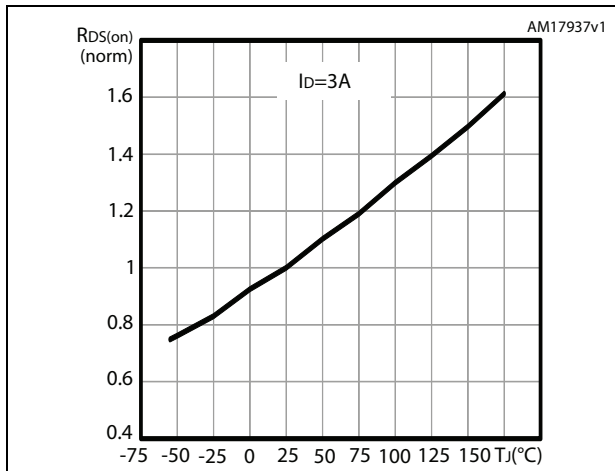

Figure 11. Normalized VDS vs temperature

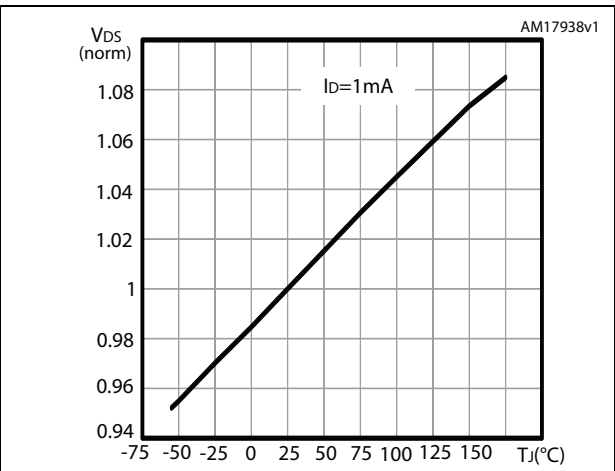
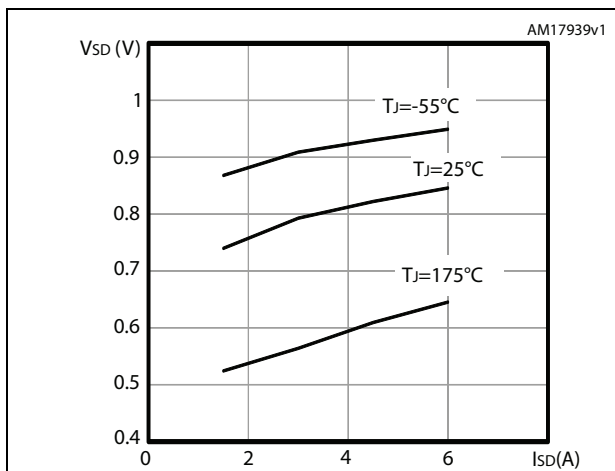

Figure 12. Source-drain diode forward characteristics



3 Test circuits

Figure 13. Switching times test circuit for resistive load

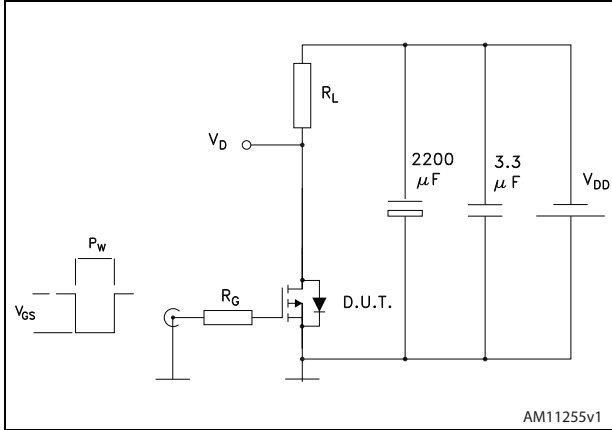

Figure 14. Gate charge test circuit

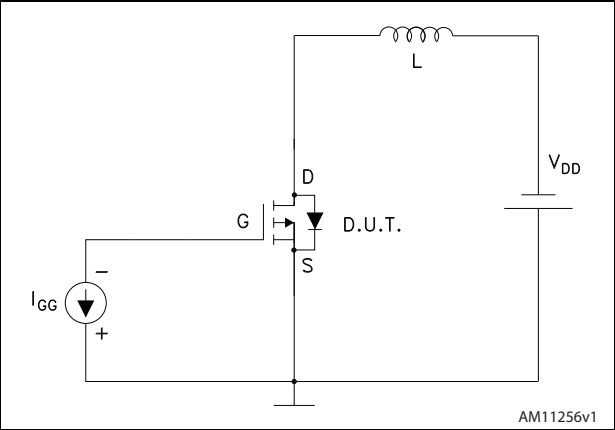
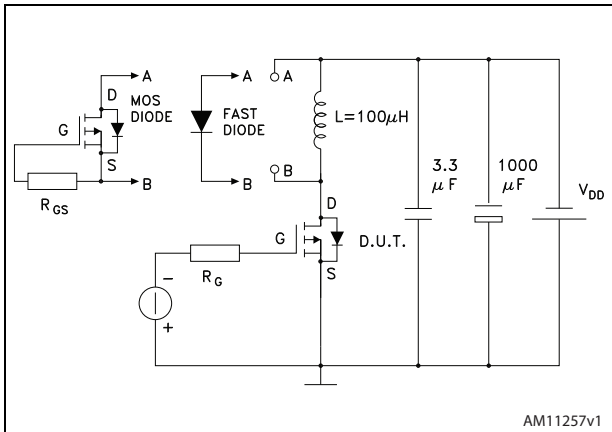

Figure 15. Test circuit for diode recovery behavior



4 Package mechanical data

In order to meet environmental requirements, ST offers these devices in different grades of ECOPACK[®] packages, depending on their level of environmental compliance. ECOPACK[®] specifications, grade definitions and product status are available at: www.st.com. ECOPACK[®] is an ST trademark.

Table 8. SO-8 mechanical data

Dim.	mm		
	Min.	Typ.	Max.
A			1.75
A1	0.10		0.25
A2	1.25		
b	0.31		0.51
b1	0.28		0.48
c	0.10		0.25
c1	0.10		0.23
D	4.80	4.90	5.00
E	5.80	6.00	6.20
E1	3.80	3.90	4.00
e		1.27	
h	0.25		0.50
L	0.40		1.27
L1		1.04	
L2		0.25	
k	0°		8°
ccc			0.10

Figure 16. SO-8 drawing

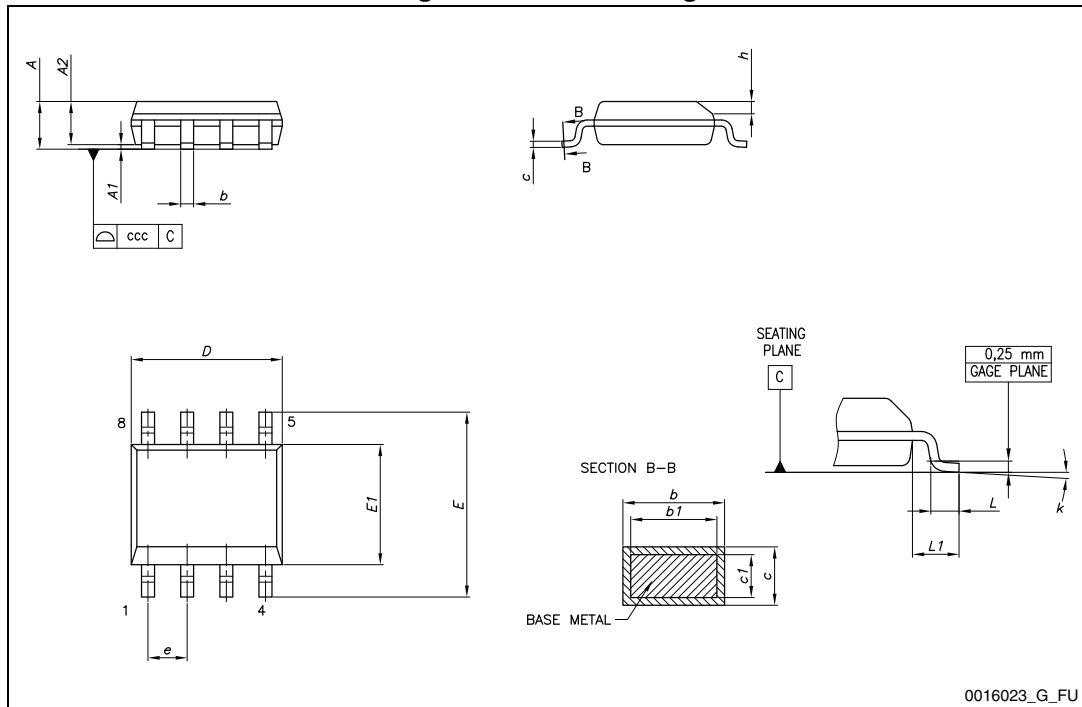

0016023_G_FU

Figure 17. SO-8 recommended footprint^(a)

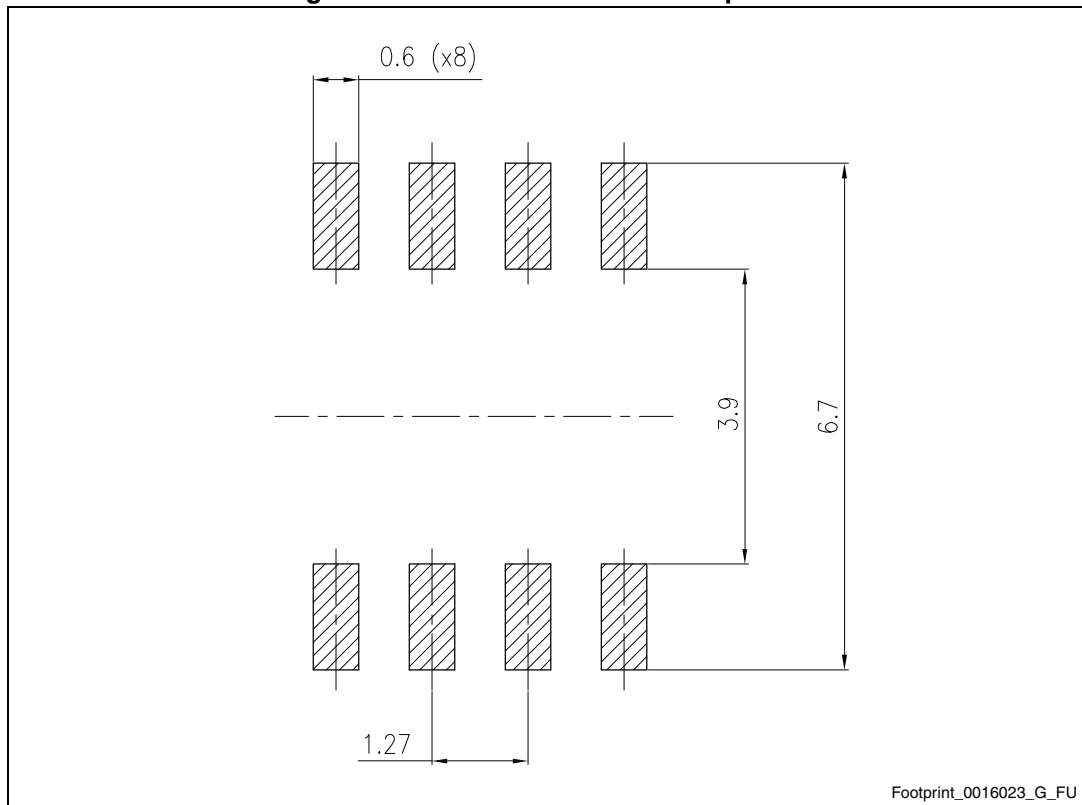

Footprint_0016023_G_FU

a. All dimensions are in millimeters.

5 Packaging mechanical data

Table 9. SO-8 tape and reel mechanical data

Dim.	mm		
	Min.	Typ.	Max.
A			330
C	12.8		13.2
D	20.2		
N	60		
T			22.4
Ao	8.1		8.5
Bo	5.5		5.9
Ko	2.1		2.3
Po	3.9		4.1
P	7.9		8.1

Figure 18. SO-8 tape and reel dimensions

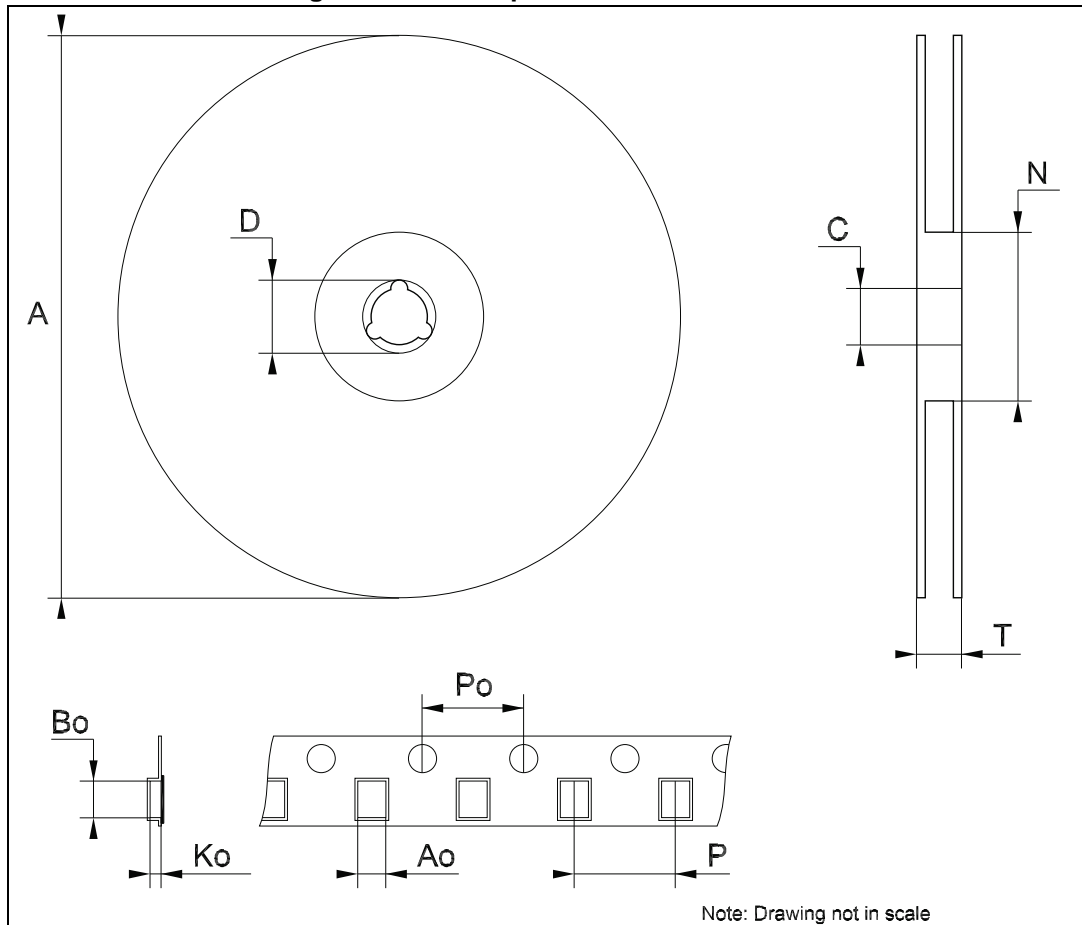

6 Revision history

Table 10. Revision history

Date	Revision	Changes
01-Feb-2013	1	First revision.
28-Nov-2013	2	<ul style="list-style-type: none">– Modified: $R_{DS(on)}$ value in cover page– Modified: V_{GS} value in Table 2– Modified: IGSS test conditions value in Table 4– Modified: Q_g typical value in Table 5– Added: Section 2.1: Electrical characteristics (curves)– Minor text changes

Please Read Carefully:

Information in this document is provided solely in connection with ST products. STMicroelectronics NV and its subsidiaries ("ST") reserve the right to make changes, corrections, modifications or improvements, to this document, and the products and services described herein at any time, without notice.

All ST products are sold pursuant to ST's terms and conditions of sale.

Purchasers are solely responsible for the choice, selection and use of the ST products and services described herein, and ST assumes no liability whatsoever relating to the choice, selection or use of the ST products and services described herein.

No license, express or implied, by estoppel or otherwise, to any intellectual property rights is granted under this document. If any part of this document refers to any third party products or services it shall not be deemed a license grant by ST for the use of such third party products or services, or any intellectual property contained therein or considered as a warranty covering the use in any manner whatsoever of such third party products or services or any intellectual property contained therein.

UNLESS OTHERWISE SET FORTH IN ST'S TERMS AND CONDITIONS OF SALE ST DISCLAIMS ANY EXPRESS OR IMPLIED WARRANTY WITH RESPECT TO THE USE AND/OR SALE OF ST PRODUCTS INCLUDING WITHOUT LIMITATION IMPLIED WARRANTIES OF MERCHANTABILITY, FITNESS FOR A PARTICULAR PURPOSE (AND THEIR EQUIVALENTS UNDER THE LAWS OF ANY JURISDICTION), OR INFRINGEMENT OF ANY PATENT, COPYRIGHT OR OTHER INTELLECTUAL PROPERTY RIGHT.

ST PRODUCTS ARE NOT DESIGNED OR AUTHORIZED FOR USE IN: (A) SAFETY CRITICAL APPLICATIONS SUCH AS LIFE SUPPORTING, ACTIVE IMPLANTED DEVICES OR SYSTEMS WITH PRODUCT FUNCTIONAL SAFETY REQUIREMENTS; (B) AERONAUTIC APPLICATIONS; (C) AUTOMOTIVE APPLICATIONS OR ENVIRONMENTS, AND/OR (D) AEROSPACE APPLICATIONS OR ENVIRONMENTS. WHERE ST PRODUCTS ARE NOT DESIGNED FOR SUCH USE, THE PURCHASER SHALL USE PRODUCTS AT PURCHASER'S SOLE RISK, EVEN IF ST HAS BEEN INFORMED IN WRITING OF SUCH USAGE, UNLESS A PRODUCT IS EXPRESSLY DESIGNATED BY ST AS BEING INTENDED FOR "AUTOMOTIVE, AUTOMOTIVE SAFETY OR MEDICAL" INDUSTRY DOMAINS ACCORDING TO ST PRODUCT DESIGN SPECIFICATIONS. PRODUCTS FORMALLY ESCC, QML OR JAN QUALIFIED ARE DEEMED SUITABLE FOR USE IN AEROSPACE BY THE CORRESPONDING GOVERNMENTAL AGENCY.

Resale of ST products with provisions different from the statements and/or technical features set forth in this document shall immediately void any warranty granted by ST for the ST product or service described herein and shall not create or extend in any manner whatsoever, any liability of ST.

ST and the ST logo are trademarks or registered trademarks of ST in various countries.
Information in this document supersedes and replaces all information previously supplied.

The ST logo is a registered trademark of STMicroelectronics. All other names are the property of their respective owners.

© 2013 STMicroelectronics - All rights reserved

STMicroelectronics group of companies

Australia - Belgium - Brazil - Canada - China - Czech Republic - Finland - France - Germany - Hong Kong - India - Israel - Italy - Japan - Malaysia - Malta - Morocco - Philippines - Singapore - Spain - Sweden - Switzerland - United Kingdom - United States of America

www.st.com

