

Ambient 2 click

2. Soldering the headers

Before using your click board™, make sure to solder 1x8 male headers to both left and right side of the board. Two 1x8 male headers are included with the board in the package.

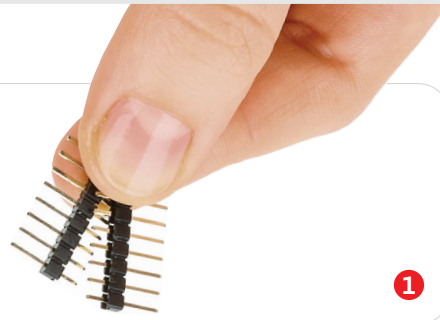

1

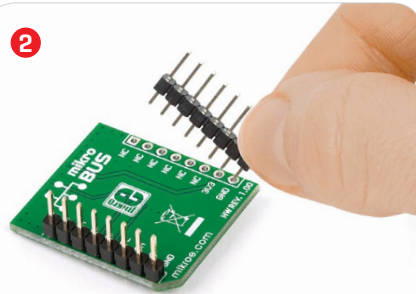

Turn the board upside down so that the bottom side is facing you upwards. Place shorter pins of the header into the appropriate soldering pads.

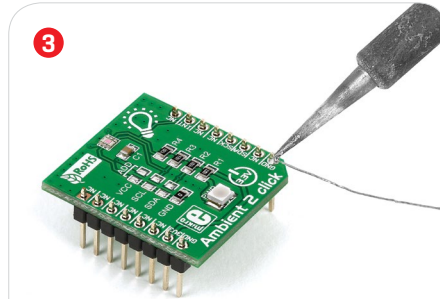

Turn the board upward again. Make sure to align the headers so that they are perpendicular to the board, then solder the pins carefully.

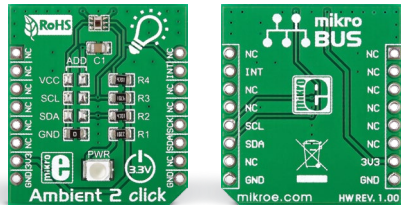

1. Introduction

Ambient 2 click carries TI's **OPT3001** ambient light sensor. It's a single-chip lux meter that measures only the visible part of the light spectrum [mimicking the human eye's response to light]. The board communicates with the target MCU through mikroBUS™ I²C pins [SCL, SDA], as well as through an interrupt pin [INT]. The board is designed to use a 3.3V power supply only.

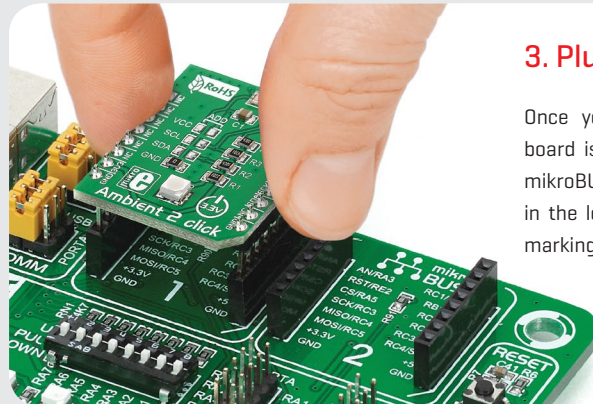

3. Plugging the board in

Once you have soldered the headers your board is ready to be placed into the desired mikroBUS™ socket. Make sure to align the cut in the lower-right part of the board with the markings on the silkscreen at the mikroBUS™ socket. If all the pins are aligned correctly, push the board all the way into the socket.

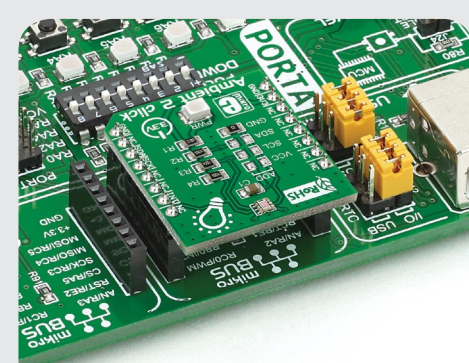

4. Essential features

The measurement range of Ambient 2 click is from 0.01 Lux to 83k lux, and a 23-bit resolution. The device filters out 99% of the infrared light spectrum, which isn't visible to the human eye. Therefore it's suitable for systems that create lighting experiences, such as display backlights, automated room lighting and similar. The optical surface of the sensor should be kept clean, but the sensor is not overly sensitive to micro shadows cast by intruding particles.

click
BOARD™
www.mikroe.com



Ambient 2 click manual
ver 1.00



010000080269

5. Schematic

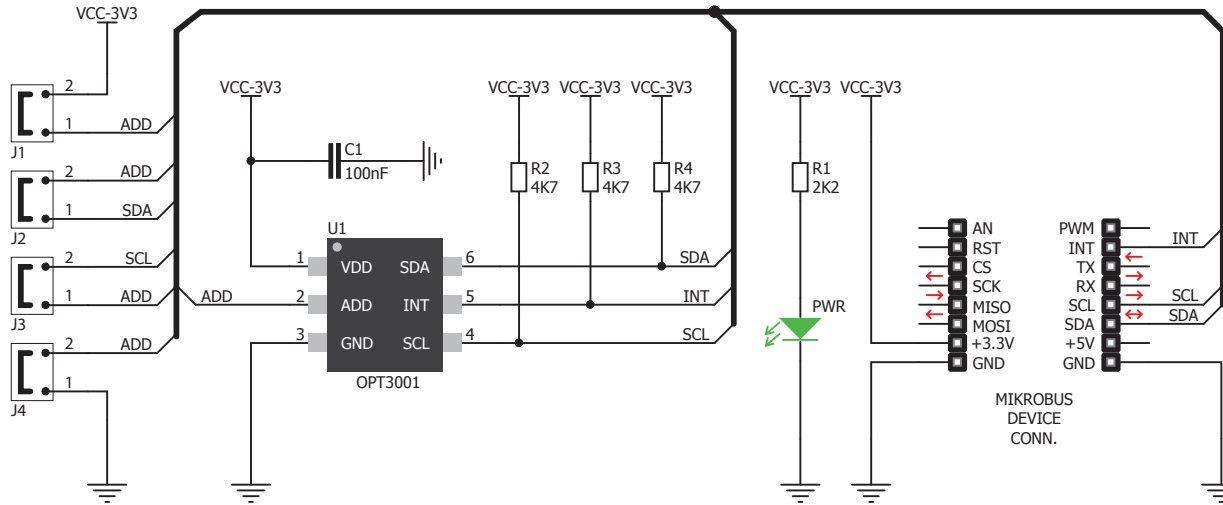

6. Dimensions

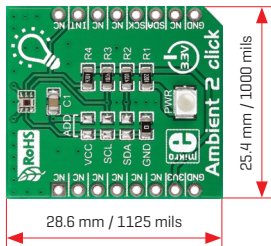

	mm	mils
LENGTH	28.6	1125
WIDTH	25.4	1000
HEIGHT*	3.3	130

* without headers

7. SMD jumpers



Ambient 2 click features four jumpers for specifying the I²C address.

8. Code examples

Once you have done all the necessary preparations, it's time to get your click board™ up and running. We have provided examples for mikroC™, mikroBasic™ and mikroPascal™ compilers on our **Libstock** website. Just download them and you are ready to start.



9. Support

MikroElektronika offers **free tech support** [www.mikroe.com/support] until the end of the product's lifetime, so if something goes wrong, we're ready and willing to help!



10. Disclaimer

MikroElektronika assumes no responsibility or liability for any errors or inaccuracies that may appear in the present document. Specification and information contained in the present schematic are subject to change at any time without notice.

Copyright © 2015 MikroElektronika.
All rights reserved.