



Technical Data Sheet

Opto Interrupter

ITR8307/TR8

■ Features

- Fast response time
- High sensitivity
- Cut-Off visible wavelength
- Thin
- Compact
- Pb free
- This product itself will remain within RoHS compliant version.

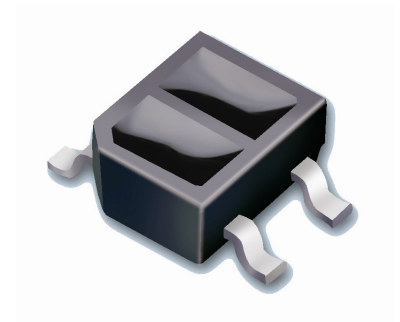

■ Descriptions

ITR8307/TR8 is a light reflection switch which includes a GaAs IR-LED transmitter and a NPN photo-transistor with a high photosensitive receiver for short distance, operating in the infrared range. Both components are mounted side- by- side in a plastic package.

■ Applications

- Camera
- VCR
- Floppy disk driver
- Cassette type recorder
- Various microcomputer control equipment

■ Device Selection Guide

Device No.	Chip Material
IR	GaAs
PT	Silicon

Package Dimensions

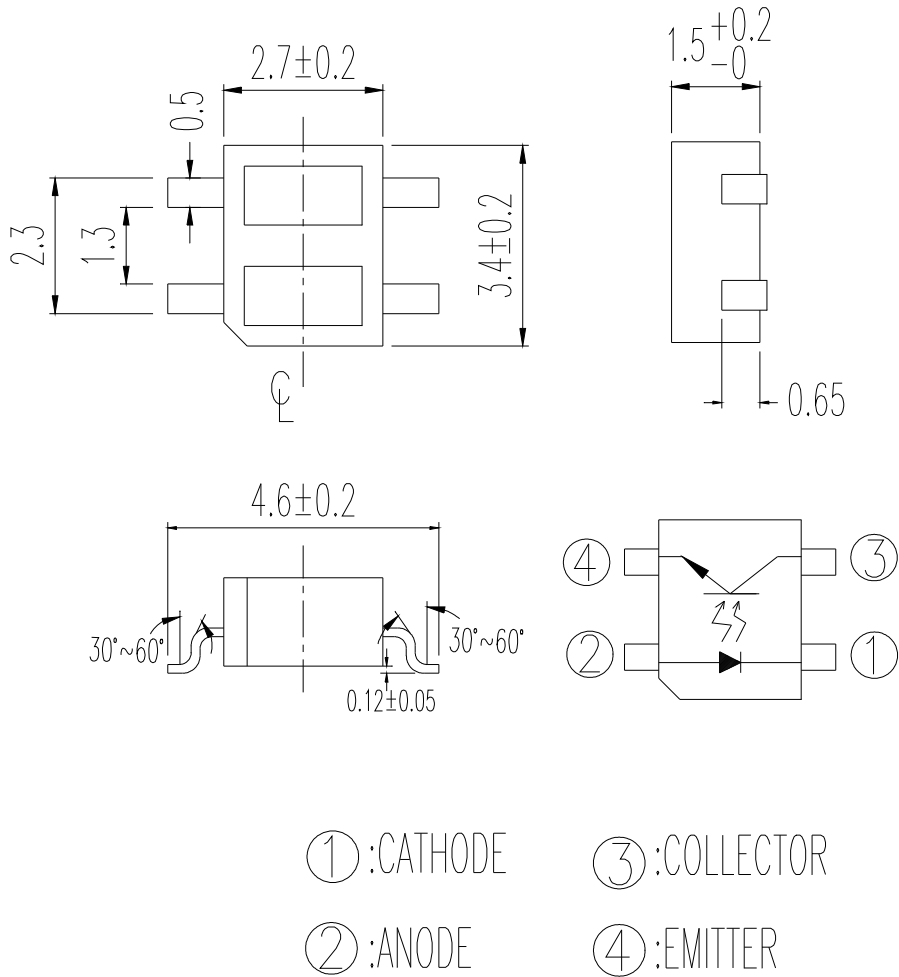

- Notes:**
1. All dimensions are in millimeters
 2. Tolerances unless dimensions ± 0.15 mm

Absolute Maximum Ratings (Ta=25°C)

Parameter		Symbol	Ratings	Unit
Input	Power Dissipation at(or below) 25°C Free Air Temperature	Pd	75	mW
	Reverse Voltage	V _R	5	V
	Forward Current	I _F	50	mA
	Peak Forward Current (*1) Pulse width ≤ 100 μs, Duty cycle=1%	I _{FP}	1	A
	Collector Power Dissipation	P _C	75	mW
Output	Collector Current	I _C	50	mA
	Collector-Emitter Voltage	B V _{CEO}	30	V
	Emitter-Collector Voltage	B V _{ECO}	5	V
	Operating Temperature	T _{opr}	-25~+85	°C
Storage Temperature	T _{stg}	-30~+100	°C	
Lead Soldering Temperature (*2)	T _{sol}	260	°C	

(*1) tw=100 μsec. , T=10 msec. (*2) t=5 Sec

Electro-Optical Characteristics (Ta=25°C)

Parameter		Symbol	Min.	Typ.	Max.	Unit	Conditions
Input	Forward Voltage	V _F	---	1.2	1.6	V	I _F =20mA
	Reverse Current	I _R	---	---	10	μA	V _R =5V
	Peak Wavelength	λ _p	---	940	---	nm	---
Output	Dark Current	I _{CEO}	---	---	100	nA	V _{CE} =10V
	C-E Saturation Voltage	V _{CE(sat)}	---	---	0.4	V	I _C =2mA ,Ee=1mW/cm ²
Transfer Characteristics	Light Current	I _{C(ON)}	0.1	---	---	mA	V _{CE} =5V
	Leakage Current	I _{CEOD}	---	---	1	μA	I _F =20mA
	Rise time	t _r	---	20	---	μsec	V _{CE} =2V
	Fall time	t _f	---	20	---	μsec	I _C =100 μA R _L =1KΩ

Typical Electrical/Optical/Characteristics Curves for IR

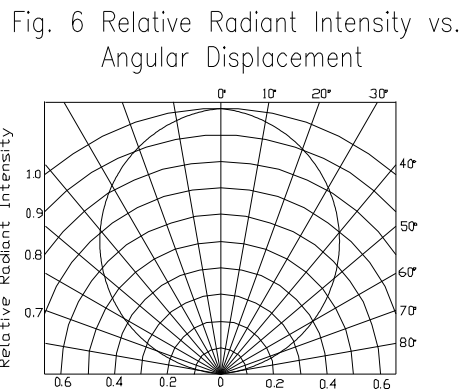
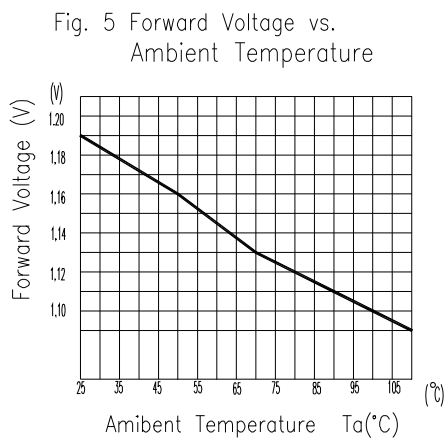
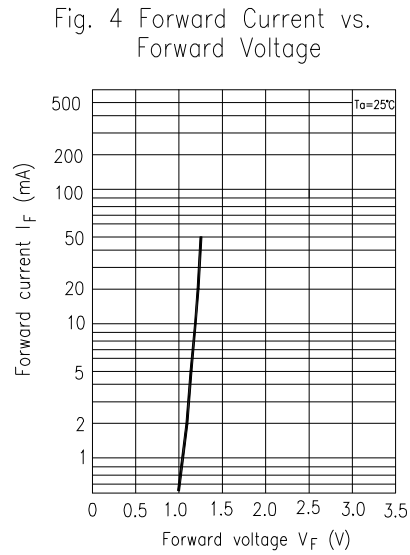
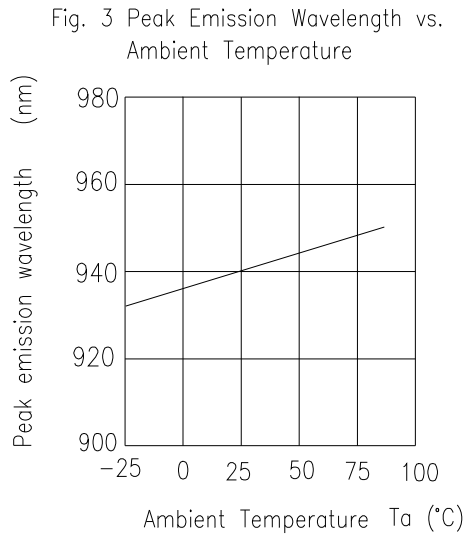
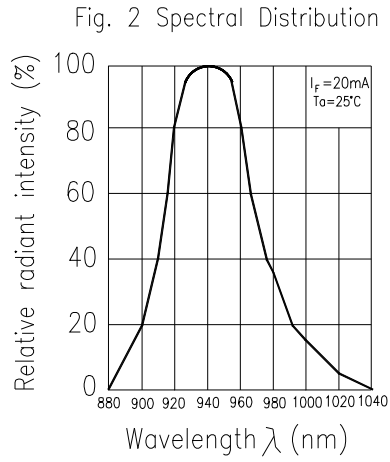
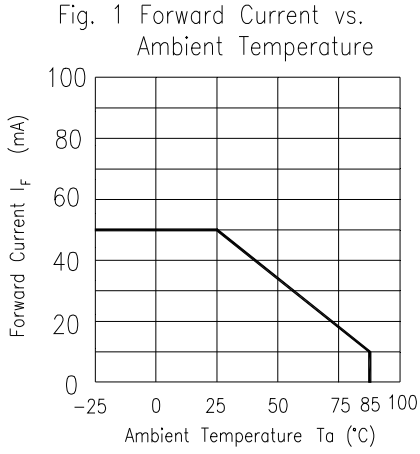

Typical Electro/Optical/Characteristics Curves for PT

Fig.1 Collector Power Dissipation vs. Ambient Temperature

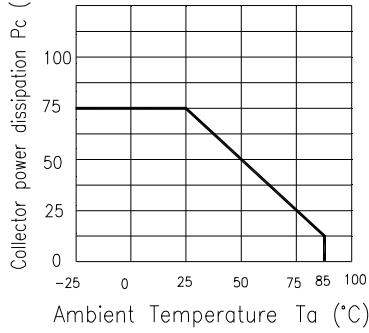

Fig.2 Collector Dark Current vs. Ambient Temperature

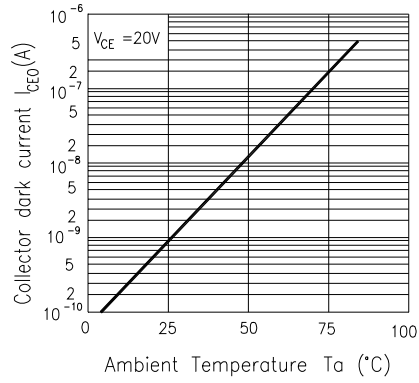

Fig. 3 Relative Collector Current vs. Ambient Temperature

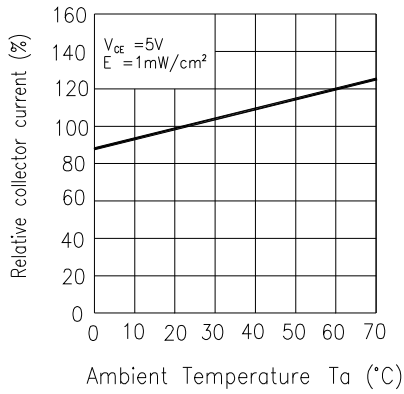

Fig.4 Collector Current vs. Irradiance

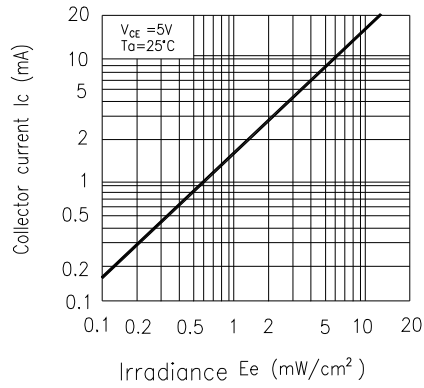

Fig.5 Spectral Sensitivity

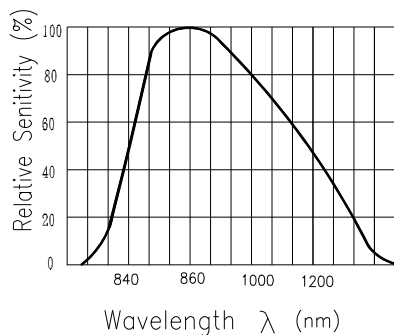
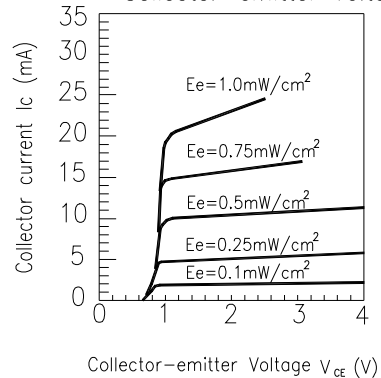

Fig.6 Collector Current vs. Collector-emitter Voltage



Typical Electrical/Optical/Characteristics Curves For ITR

Fig.1 Relative Collector Current vs. Distance between Sensor and Al Evaporation Galss

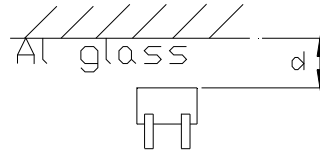
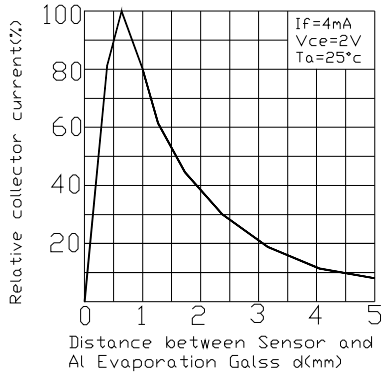

Fig.2 Relative Collector Current vs. Card Moving Distance (l)

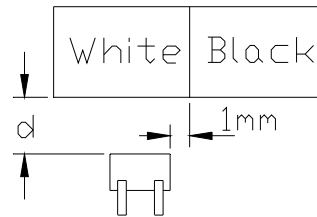
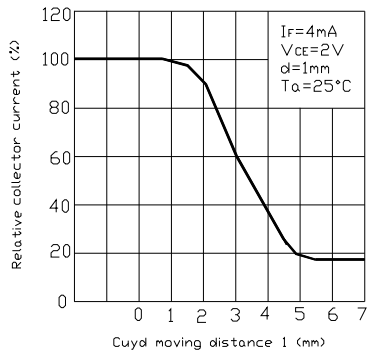
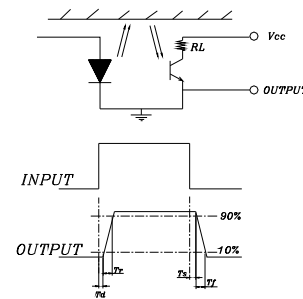
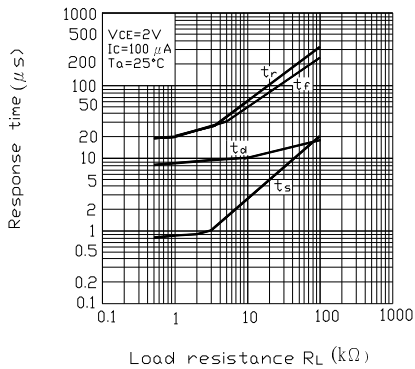

Fig.3 Response Time vs. Load Resistance



Reliability Test Item And Condition

The reliability of products shall be satisfied with items listed below.

Confidence level : 90%

LTPD : 10%

NO.	Item	Test Conditions	Test Hours/ Cycles	Sample Sizes	Failure Judgement Criteria	Ac/Re
1	Solder Heat	TEMP. : 260°C±5°C	10secs	22pcs	$I_R \geq U \times 2$ $E_e \leq L \times 0.8$ $V_F \geq U \times 1.2$ U : Upper Specification Limit L : Lower Specification Limit	0/1
2	Temperature Cycle	H : +85°C 30mins ↑ 5mins ↓ L : -55°C 30mins	50Cycles	22pcs		0/1
3	Thermal Shock	H : +100°C 5mins ↑ 10secs ↓ L : -10°C 5mins	50Cycles	22pcs		0/1
4	High Temperature Storage	TEMP. : +100°C	1000hrs	22pcs		0/1
5	Low Temperature Storage	TEMP. : -55°C	1000hrs	22pcs		0/1
6	DC Operating Life	$I_F=20mA$	1000hrs	22pcs		0/1
7	High Temperature/ High Humidity	85°C / 85% R.H	1000hrs	22pcs		0/1

Recommended Method of Storage

The following are general recommendations for moisture sensitive level (MSL) 4 storage and use:

- Shelf life in sealed bag: 12 months at < 40 °C and < 90% relative humidity (RH)
- After bag is opened, devices that will be subjected to reflow solder or other high temperature process must
 - a) Mounted within 72 hours of factory conditions < 30 °C/60%RH, or
 - b) Stored at <20% RH
- Devices require bake, before mounting, if:
Humidity Indicator Card is > 20% when read at 23 ± 5 °C
- If baking is required, devices may be baked:
 - a) 192 hours at 40°C, and <5% RH(dry air/nitrogen) or
 - b) 96 hours at 60°C, and <5% RH for all device containers
 - c) 24 hours at 125 °C
- Soldering Condition
 - a) Pb-free solder temperature profile

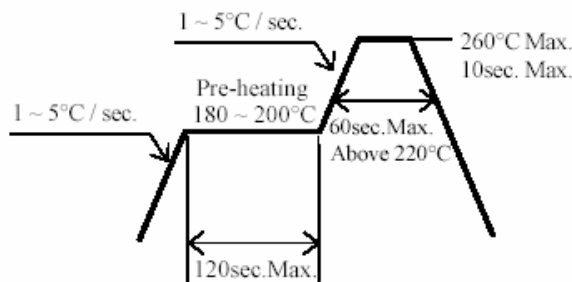

- b) Reflow soldering should not be done more than two times.
 - c) When soldering, do not put stress on the LEDs during heating.
 - d) After soldering, do not warp the circuit board.
- Repairing

Repair should not be done after the LEDs have been soldered. When repairing is unavoidable, a double-head soldering iron should be used (as below figure). It should be confirmed beforehand whether the characteristics of the LEDs will or will not be damaged by repairing.

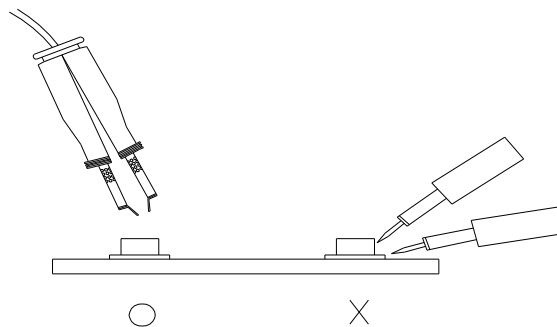

Taping Dimension

Progressive direction 

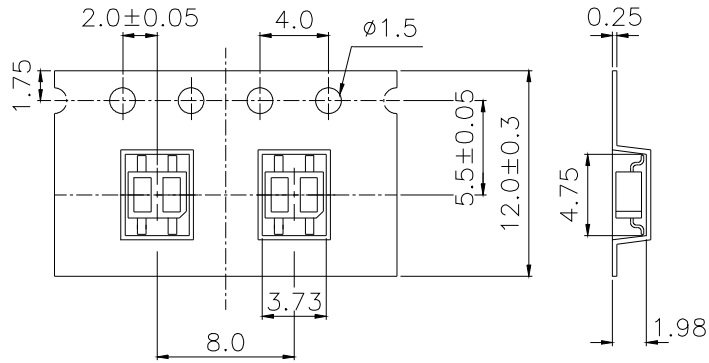

General Tolerance ±0.1
UNIT:mm

Reel Dimensions

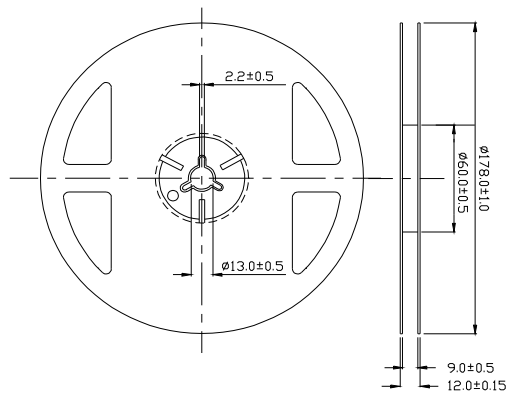

Note: The tolerances unless mentioned is ±0.1mm ,Unit = mm

Moisture Resistant Packaging

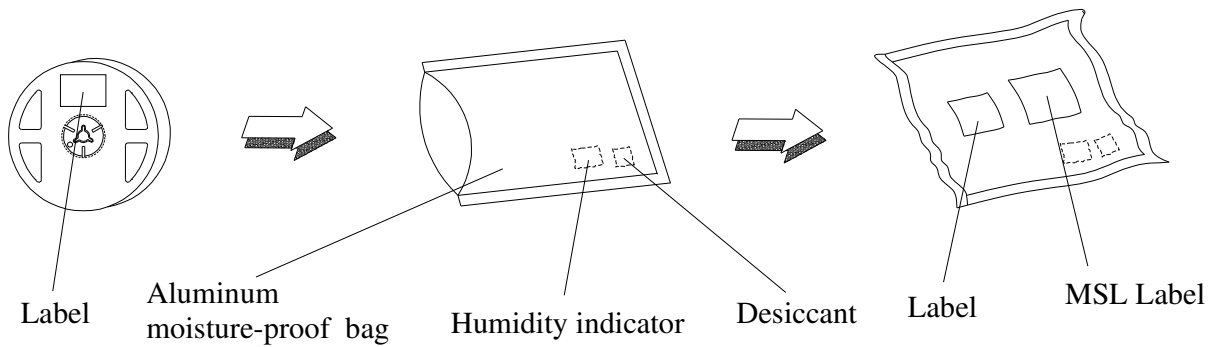



Packing Quantity Specification

1. 1000 Pcs/ 1Reel
2. 15 Reel /1 Box
3. 2 Box/ 1 Carton

Label Form Specification

Humidity indicator:

HUMIDITY INDICATOR

Examine Item if Pink		Discard if Circles Overrun Avoid Metal Contact
Change Desiccant if Pink		
Warning if Pink		

DESICCARE, INC.
Pomona, California USA

MSL Label



Caution

This bag contains
MOISTURE-SENSITIVE DEVICES

LEVEL

4

1. Calculated shelf life in sealed bag: 12 months at <30°C and <60% relative humidity (RH)
2. Peak package body temperature: _____ 260 _____ °C
3. After bag is opened, devices that will be subjected to reflow Solder or other high temperature process must
 - a) Mounted within: _____ 72 _____ hours of factory conditions <30°C / 60%RH. OR
 - b) Stored at <10% RH
4. Devices require bake, before mounting. If:
 - a) Humidity Indicator Card is >30% when read at 23±5°C
 - b) 3a or 3b not met
5. If baking is required, devices may be baked for 24 hours at 125±5°C

Note: If device containers cannot be subjected to high temperature or shorter bake times are desired.
Reference IPC/JEDEC J-STD-033 for bake procedure
Bag Seal Date: _____

Note: Level and body temperature defined by IPC/JEDEC J-STD-020

EVERLIGHT Label





CPN:
P/N:



RoHS

ITR8307/TR8

QTY: _____ CAT: _____
HUE: _____ REF: _____

LOT NO: _____



MADE IN TAIWAN

CPN: Customer's Production Number

P/N : Production Number

QTY: Packing Quantity

CAT: None

HUE: None

REF: Reference

LOT No: Lot Number

MADE IN TAIWAN: Production Place

Notes

1. Above specification may be changed without notice. EVERLIGHT will reserve authority on material change for above specification.
2. When using this product, please observe the absolute maximum ratings and the instructions for using outlined in these specification sheets. EVERLIGHT assumes no responsibility for any damage resulting from use of the product which does not comply with the absolute maximum ratings and the instructions included in these specification sheets.
3. These specification sheets include materials protected under copyright of EVERLIGHT corporation. Please don't reproduce or cause anyone to reproduce them without EVERLIGHT's consent.

EVERLIGHT ELECTRONICS CO., LTD.
*Office: No 25, Lane 76, Sec 3, Chung Yang Rd,
Tucheng, Taipei 236, Taiwan, R.O.C*

*Tel: 886-2-2267-2000, 2267-9936
Fax: 886-2267-6244, 2267-6189, 2267-6306
<http://www.everlight.com>*