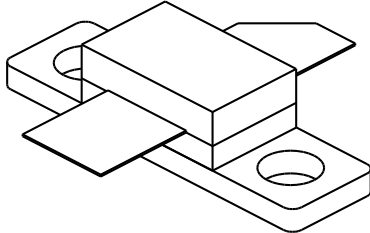

0912-25

25 Watts, 50 Volts, Pulsed
Avionics 960 - 1215 MHz

<p>GENERAL DESCRIPTION</p> <p>The 0912-25 is a COMMON BASE bipolar transistor. It is designed for pulsed systems in the frequency band 960-1215 MHz. The device has gold thin-film metallization for proven highest MTF. The transistor includes input prematch for broadband capability. Low thermal resistance package reduces junction temperature, extends life.</p>	<p>CASE OUTLINE 55CX, STYLE 1</p> 
<p>ABSOLUTE MAXIMUM RATINGS</p> <p>Maximum Power Dissipation @ 25°C² 125 Watts</p> <p>Maximum Voltage and Current</p> <p>BVces Collector to Base Voltage 60 Volts BVebo Emitter to Base Voltage 4.0 Volts Ic Collector Current 2.5 Amps</p> <p>Maximum Temperatures</p> <p>Storage Temperature - 65 to + 150°C Operating Junction Temperature + 200°C</p>	

ELECTRICAL CHARACTERISTICS @ 25 °C

SYMBOL	CHARACTERISTICS	TEST CONDITIONS	MIN	TYP	MAX	UNITS
Pout	Power Out	F = 960-1215 MHz	25			Watts
Pin	Power Input	Vcc = 50 Volts			3.5	Watts
Pg	Power Gain	PW = 10 µsec	8.5	10		dB
η_c	Collector Efficiency	DF = 1 %		45		%
VSWR	Load Mismatch Tolerance	F = 1090 MHz			10:1	

BVebo	Emitter to Base Breakdown	Ie = 25 mA	4.0			Volts
BVces	Collector to Emitter Breakdown	Ic = 75 mA	55			Volts
Cob	Capacitance Collector to Base	Vcb = 50 Volts		14	17	pF
hFE	DC - Current Gain	Ic = 300 mA, Vce = 5 V	10			
θ_{jc}^2	Thermal Resistance				1.4	°C/W

Note 1: At rated output power and pulse conditions.
Note 2: At rated pulse conditions

Initial Issue June 1, 1994

GHZ TECHNOLOGY INC. RESERVES THE RIGHT TO MAKE CHANGES WITHOUT FURTHER NOTICE. GHZ RECOMMENDS THAT BEFORE THE PRODUCT(S) DESCRIBED HEREIN ARE WRITTEN INTO SPECIFICATIONS, OR USED IN CRITICAL APPLICATIONS, THAT THE PERFORMANCE CHARACTERISTICS BE VERIFIED BY CONTACTING THE FACTORY.



GHZ TECHNOLOGY
RF-MICROWAVE SILICON POWER TRANSISTORS

0912-25

WIDEBAND CIRCUIT INPUT RETURN LOSS

Pin = 3.5 Watt Pk, Vcc = 50 Volts

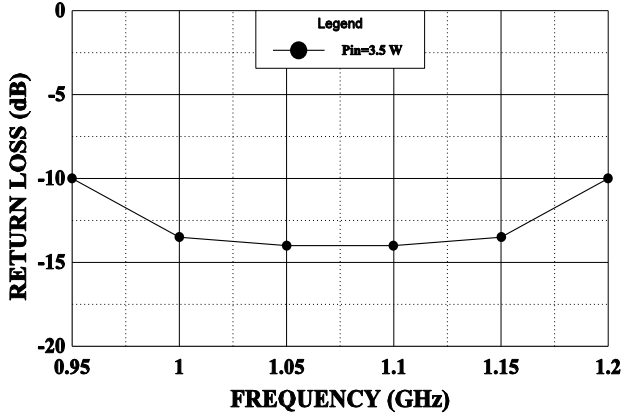

POWER OUTPUT vs POWER INPUT

Vcc = 50V, Frequency 1090 MHz

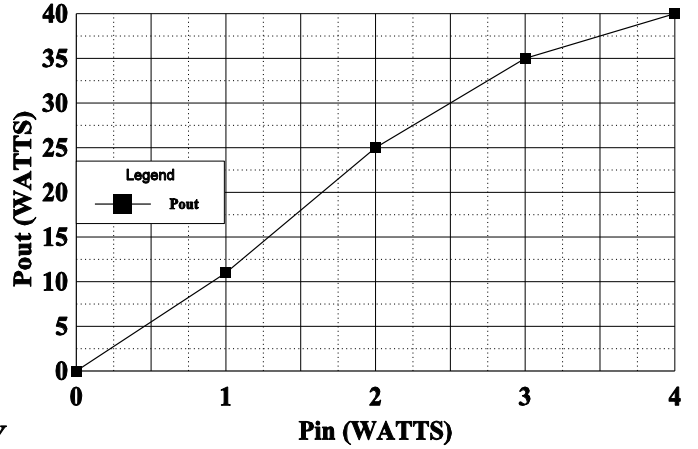

Pout VS FREQUENCY

Vcc=50V, Pin = 3.5 W

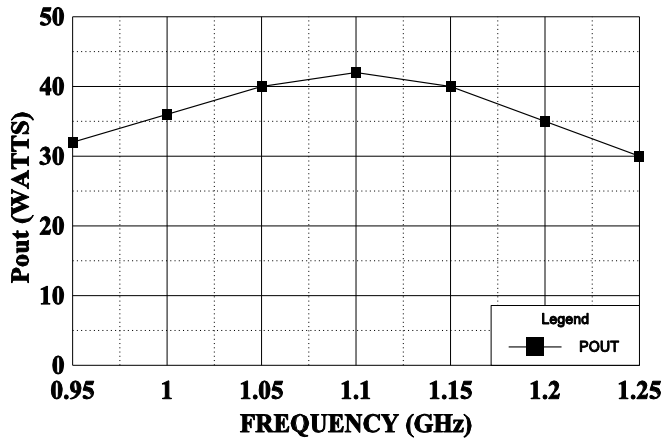

SERIES INPUT IMPEDANCE vs FREQUENCY

Vcc = 50 V, Pin = 1 W

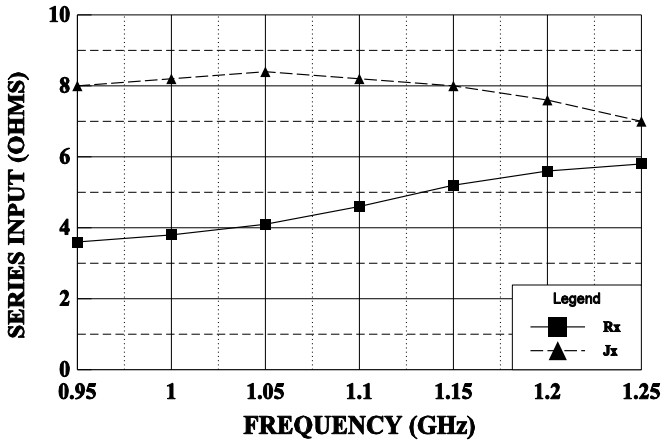

SERIES LOAD IMPEDANCE vs FREQUENCY

Vcc = 50 V, Pin = 3.5W

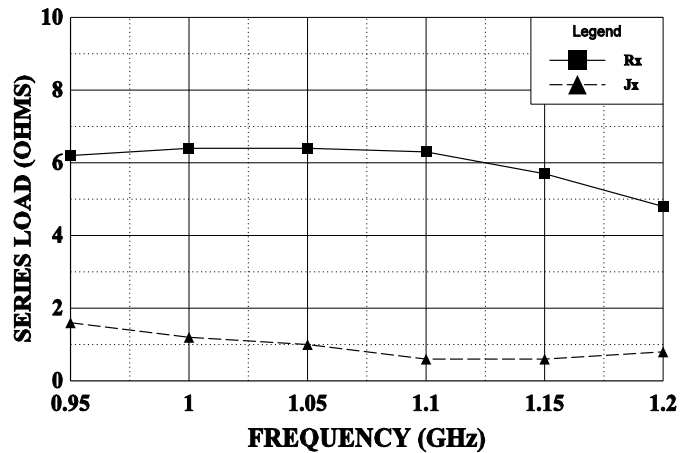

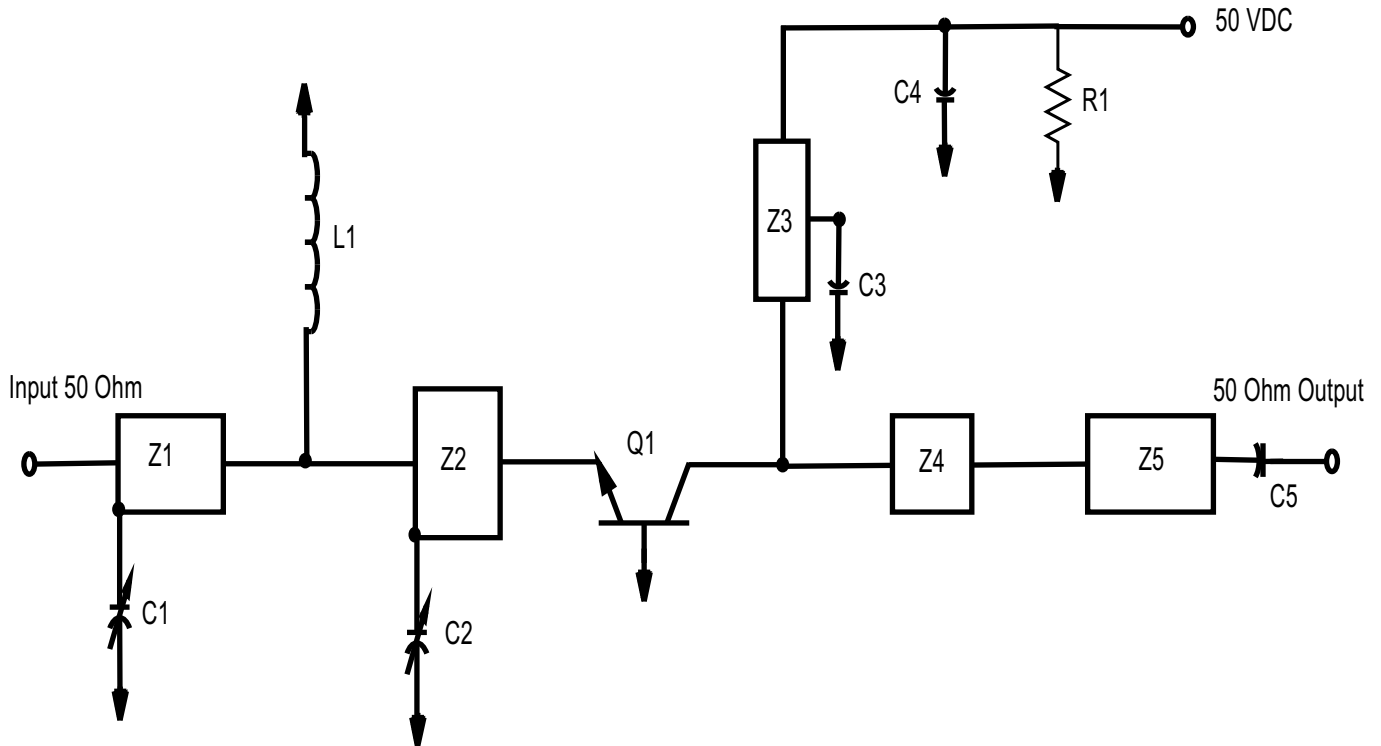

PC Board Material .010" Dielectric Teflon Fiberglass

Z1=50 , .112 , .27"w X .834"L

Z2=9 , .116 , .22"w X .811"L

Z3=50 , .7 , .27"w X 1.2"L

Move along Z3 for best tuning

Z4=10 , .04 , .2"w X .28"L

Z5=18.3 , .25 , .1"w X .18"L

C1, C2=Capacitor, .35-3.5 pF piston trimmer

C3, C5=Capacitor, 47 pF "B" (100mil) ATC

C4= Capacitor, 50 mf 75V electrolytic

L1=Inductor, #18 wire 1 1/2 turns 1/4" diameter

Q1=GHz 0912-25