

PRODUCT NUMBER SEE SHEET 2

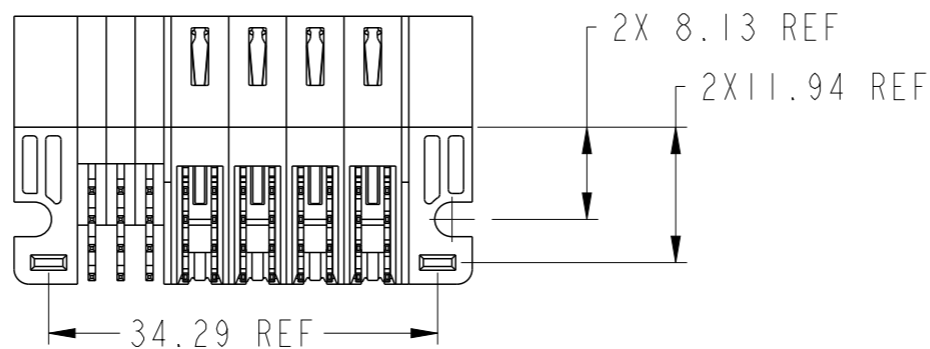

spec ref	*	dr	Xie Bob	2014/04/02	projection	MM	size	A3	scale	3:2	
tolerance std	ASME Y14.5	eng	Xie Bob	2014/04/08			ecn no	-	rel level	Released	
TOLERANCES UNLESS OTHERWISE SPECIFIED		chr	Li-He	2014/04/08							product family
surface	<input checked="" type="checkbox"/> linear <input type="checkbox"/> angular	appr	Pei-Ming Zheng	2014/04/08			title 12S+4HDP RA STB HEADER	dwg no 10106132-4003002	rev A	cat. no. Product - Customer Drw	sheet 1 of 3
ASME Y14.5	0.X ±0.5 0.XX ±0.25 0.XXX ±0.10 0° ±2°	www.fci.com		PDS: Rev :A		STATUS:Released		Printed: Apr 09, 2014			

PRODUCT NO.	ROWS	SIG			HIGH POWER				E2
		E1	1	2	3	P1	P2	P3	
10106132-4003002LF	DCBA	U	U	U	H1	H1	H1	H1	U
		T	T	T					
		S	S	S					
		R	R	R					

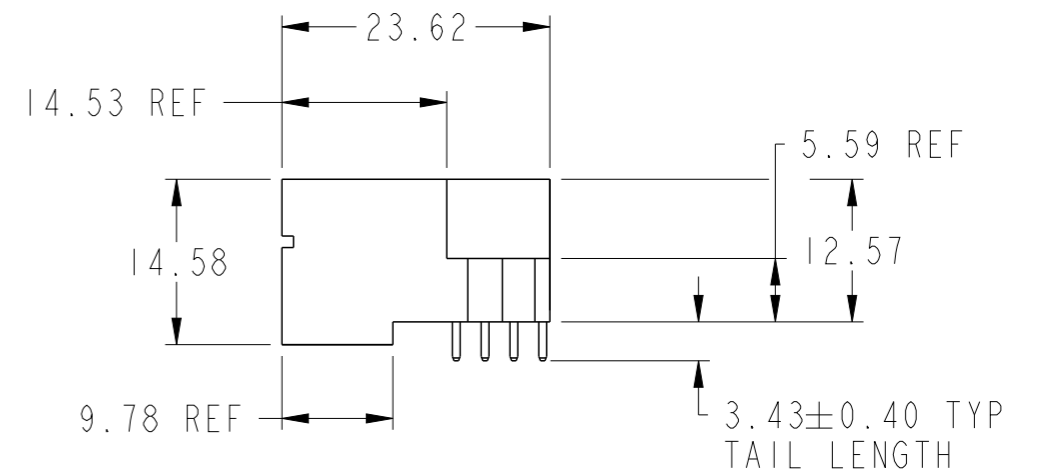
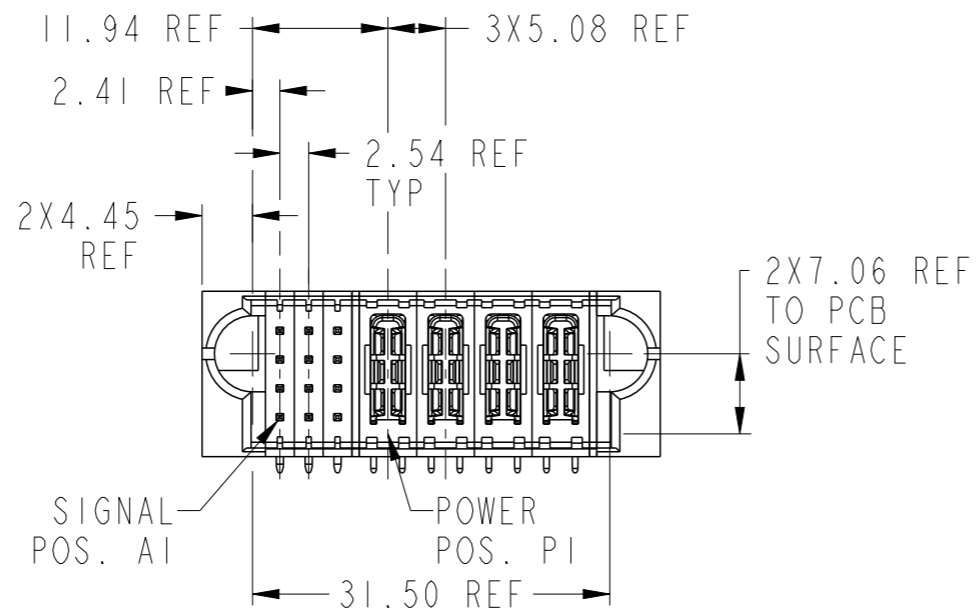
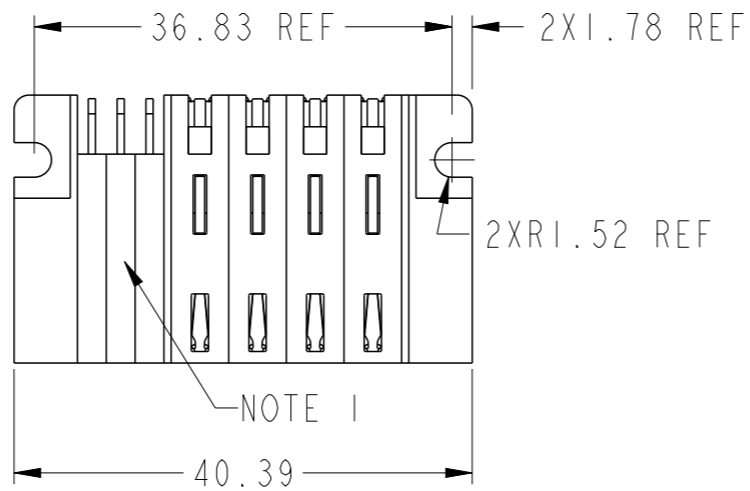
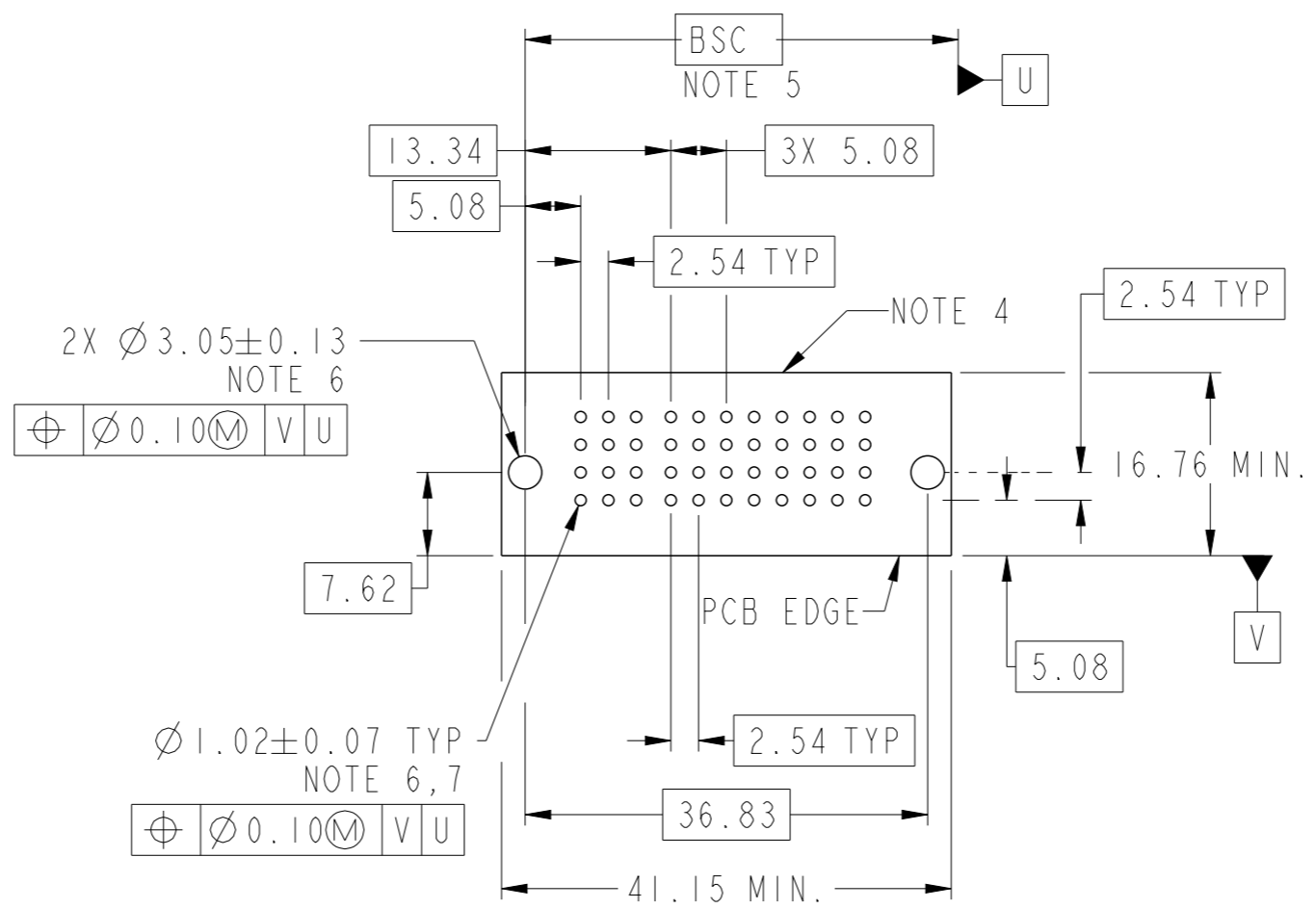

CODE	DESCRIPTION
HI	STD HIGH POWER CONTACT (3.43)
R	STD SIGNAL CONTACT, ROW A (3.43)
S	STD SIGNAL CONTACT, ROW B (3.43)
T	STD SIGNAL CONTACT, ROW C (3.43)
U	STD SIGNAL CONTACT, ROW D (3.43)

dr	Xie Bob	2014/04/02	projection	MM	size	A3	scale	3:2
eng	Xie Bob	2014/04/08			ecn no	-	rel level	Released
chr	Li-He	2014/04/08						
appr	Pei-Ming Zheng	2014/04/08	product family	PwrBlade+				
			title 12S+4HDP RA STB HEADER		dwg no 10106132-4003002		rev A	
www.fci.com			cat. no.		Product - Customer Drw			sheet 2 of 3



Copyright FCI.

NOTES:

- 1) "FCI", PART NUMBER AND DATE CODE TO BE MARKED ON THIS SURFACE.  
THE MARK CAN BE OMITTED IF THERE IS NOT ENOUGH SPACE ON THIS SURFACE.
- 2) MATERIALS:  
-HOUSING - GLASS FILLED WITH HIGH TEMP THERMOPLASTIC, UL94V-0.  
-SIGNAL CONTACT - COPPER ALLOY.  
-POWER CONTACT - HIGH CONDUCTIVITY COPPER ALLOY.
- 3) PLATING SPECIFICATION REFER TO FCI 10116351
- 4) DENOTES CONNECTOR KEEP OUT ZONE.
- 5) DATUM AND BASIC DIMENSIONS WERE ESTABLISHED BY CUSTOMER.
- 6) ALL HOLE DIAMETERS ARE FINISHED HOLE SIZES.
- 7)  $1.15 \pm 0.025$ MM DRILLED HOLE PLATED WITH 0.00762MM MIN Sn  
OVER 0.0254-0.0762MM Cu PLATING TO ACHIEVE A  $1.02 \pm 0.07$ MM HOLE.
- 8) PRODUCT SPECIFICATION REFER TO FCI GS-12-658.  
APPLICATION SPECIFICATION REFER TO FCI GS-20-141.  
PRODUCT PACKAGED IN TRAYS, REFER TO FCI GS-14-1502.

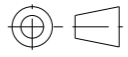
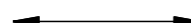

Copyright FCI.

dr	Xie Bob	2014/04/02	projection 	MM 	size	A3	scale	3:2
eng	Xie Bob	2014/04/08			ecn no	-		
chr	Li-He	2014/04/08			rel level	Released		
appr	Pei-Ming Zheng	2014/04/08	product family	PwrBlade+				
		title 12S+4HDP RA STB HEADER		dwg no 10106132-4003002	rev A			
www.fci.com		cat. no.	Product - Customer Drw		sheet 3 of 3			