

Power Operational Amplifier

FEATURES

- ◆ A Unique (Patent Pending) Technique for Very Low Quiescent Current
- ◆ Over 350 V/μs Slew Rate
- ◆ Wide Supply Voltage
 - ◆ Single Supply: 20V To 350V
 - ◆ Split Supplies: ± 10V To ± 175V
- ◆ Output Current – 150mA Cont.; 200mA Pk
- ◆ Up to 23 Watt Dissipation Capability
- ◆ Over 200 kHz Power Bandwidth

APPLICATIONS

- ◆ Piezoelectric Positioning and Actuation
- ◆ Electrostatic Deflection
- ◆ Deformable Mirror Actuators
- ◆ Chemical and Biological Stimulators

DESCRIPTION

The PA78 is a high voltage, high speed, low idle current op-amp capable of delivering up to 200mA peak output current. Due to the dynamic biasing of the input stage, it can achieve slew rates over 350V/μs, while only consuming less than 1mA of idle current. External phase compensation allows great flexibility for the user to optimize bandwidth and stability.

The output stage is protected with user selected current limit resistor. For the selection of this current limiting resistor, pay close attention to the SOA curves for each package type. Proper heatsinking is required for maximum reliability.

BLOCK DIAGRAM

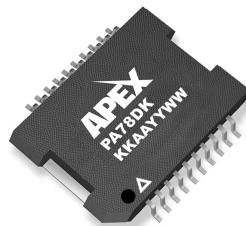
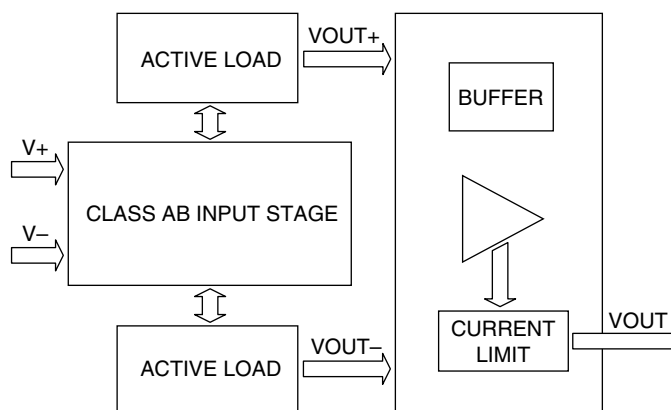

**20-Pin PSOP
 PACKAGE STYLE DK**

CHARACTERISTICS AND SPECIFICATIONS

ABSOLUTE MAXIMUM RATINGS

Parameter	Symbol	Min	Max	Units
SUPPLY VOLTAGE, $+V_s$ to $-V_s$			350	V
OUTPUT CURRENT, peak (200ms), within SOA			200	mA
POWER DISSIPATION, internal, DC			14	W
INPUT VOLTAGE, differential		-15	16	V
INPUT VOLTAGE, common mode		$-V_s$	$+V_s$	V
TEMPERATURE, junction (Note 2)			150	°C
TEMPERATURE RANGE, storage		-55	125	°C
OPERATING TEMPERATURE, case		-40	125	°C

SPECIFICATIONS

Parameter	Test Conditions	Min	Typ	Max	Units
INPUT					
OFFSET VOLTAGE		-40	8	40	mV
OFFSET VOLTAGE vs. temperature	0 to 125°C (Case Temperature)		-63		$\mu\text{V}/^\circ\text{C}$
OFFSET VOLTAGE vs. supply				32	$\mu\text{V}/\text{V}$
BIAS CURRENT, initial			8.5	200	pA
OFFSET CURRENT, initial			12	400	pA
INPUT RESISTANCE, DC			10^8		Ω
COMMON MODE VOLTAGE RANGE, pos.			$+V_s - 2$		V
COMMON MODE VOLTAGE RANGE, neg.			$-V_s + 5.5$		V
COMMON MODE REJECTION, DC		90	118		dB
NOISE	700KHz		418		$\mu\text{V RMS}$
NOISE, V_o NOISE			500		$\text{nV}/\sqrt{\text{Hz}}$
GAIN					
OPEN LOOP @ 1Hz		89	120		dB
GAIN BANDWIDTH PRODUCT @ 1MHz				1	MHz
PHASE MARGIN	Full temperature range		50		°
OUTPUT					
VOLTAGE SWING	$I_o = 10\text{mA}$		$ V_s - 2$		V
VOLTAGE SWING	$I_o = 100\text{mA}$		$ V_s - 8.6$	$ V_s - 12$	V
VOLTAGE SWING	$I_o = 150\text{mA}$		$ V_s - 10$		V
CURRENT, continuous, DC		150			mA
SLEW RATE	Package Tab connected to GND	100	350		$\text{V}/\mu\text{S}$
SETTLING TIME, to 0.1%	2V Step		1		μS
POWER BANDWIDTH, $300V_{P-P}$	$+V_s = 160\text{V}$, $-V_s = -160\text{V}$		200		kHz
OUTPUT RESISTANCE, No load	$R_{CL} = 6.2\Omega$		44		Ω
POWER SUPPLY					
VOLTAGE		± 10	± 150	± 175	V
CURRENT, quiescent (Note 5)	$\pm 150\text{V}$ Supply	0.2	0.7	2.5	mA

Parameter	Test Conditions	Min	Typ	Max	Units
THERMAL					
RESISTANCE, DC, junction to case	Full temperature range		8.3	9.1	°C/W
RESISTANCE, DC, junction to air (Note 6)	Full temperature range		25		°C/W
RESISTANCE, DC, junction to air (Note 7)	Full temperature range		19.1		°C/W
TEMPERATURE RANGE, case		-40		125	°C

- NOTES: 1. Unless otherwise noted: $T_c = 25^\circ\text{C}$, DC input specifications are \pm value given, power supply voltage is typical rating.
2. Long term operation at the maximum junction temperature will result in reduced product life. Derate power dissipation to achieve high MTTF.
3. $+V_s$ and $-V_s$ denote the positive and negative supply voltages of the output stage.
4. Rating applies if output current alternates between both output transistors at a rate faster than 60Hz.
5. Supply current increases with signal frequency. See graph on page 4.
6. Rating applies when the heatslug of the DK package is soldered to a minimum of 1 square inch foil area of a printed circuit board.
7. Rating applies with the JEDEC conditions outlined in the Heatsinking section of this datasheet.

EXTERNAL CONNECTIONS

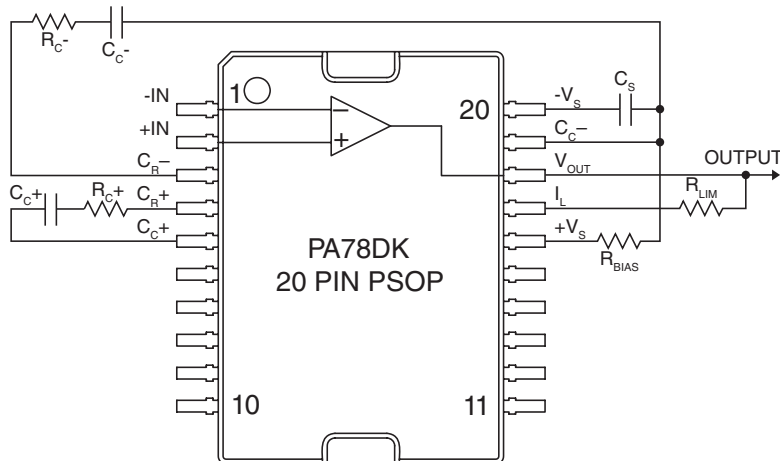

TYPICAL APPLICATION CIRCUIT

The PA78 is ideally suited for driving continuous drop ink jet printers, in both piezo actuation and deflection applications. The high voltage of the amplifier creates an electrostatic field on the deflection plates to control the position of the ink droplets. The rate at which droplets can be printed is directly related to the rate at which the amplifier can drive the plate to a different electrostatic field strength.

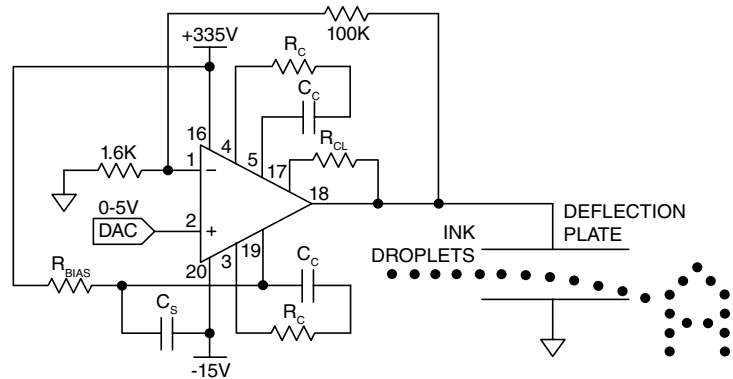

TYPICAL PERFORMANCE GRAPHS

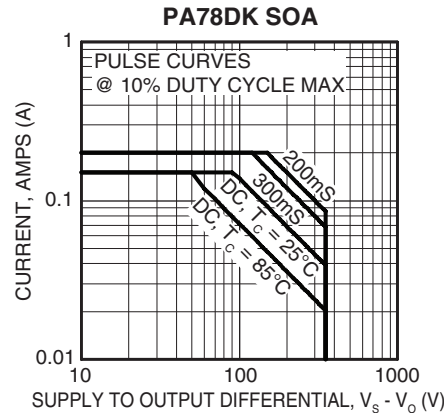
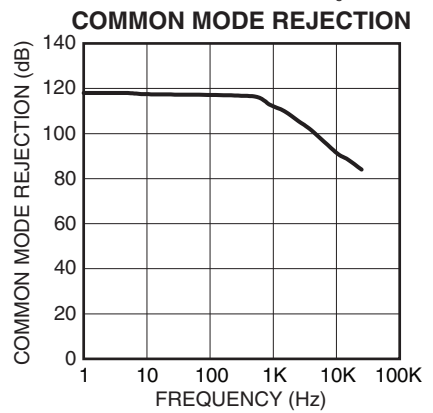
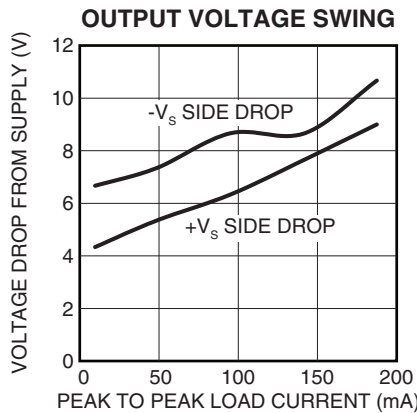
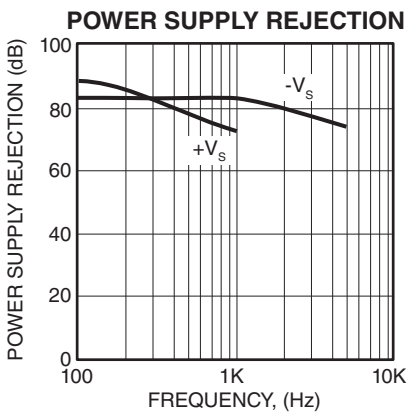
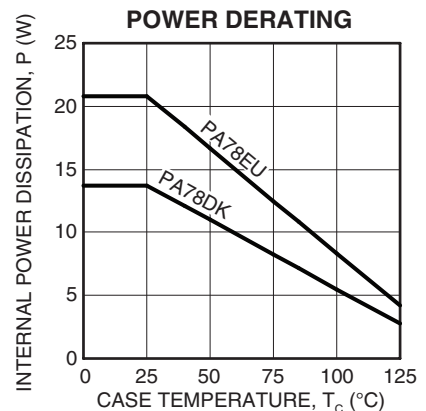
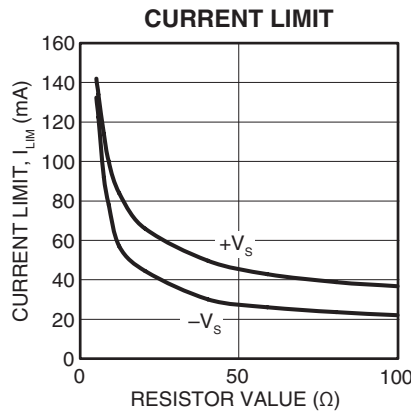
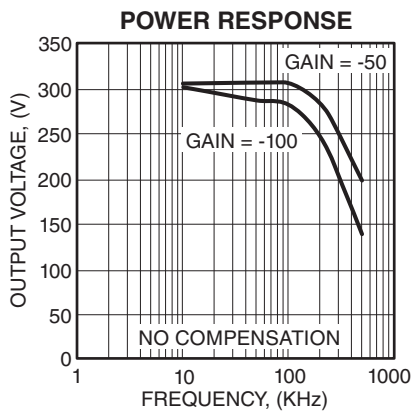

SMALL SIGNAL OPEN LOOP GAIN

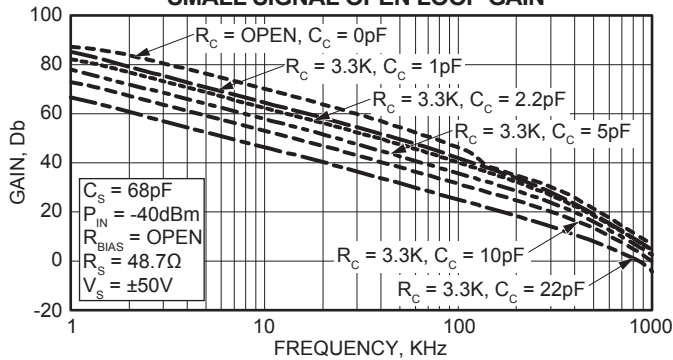

SMALL SIGNAL OPEN LOOP PHASE, $V_o = 250mV_{P-P}$

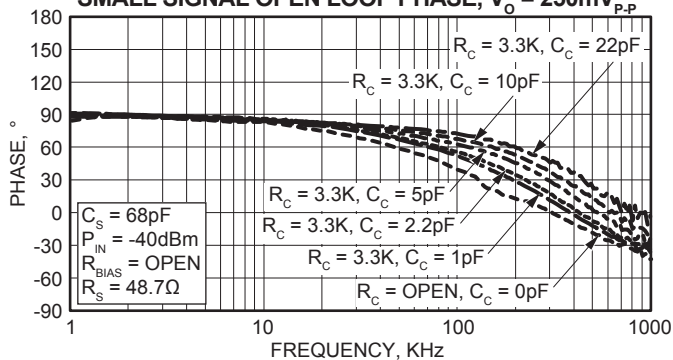

SMALL SIGNAL OPEN LOOP PHASE

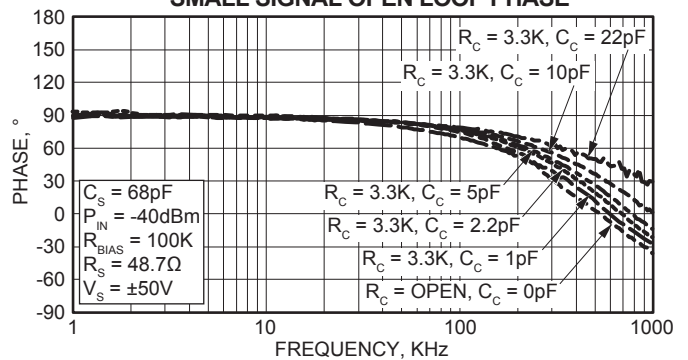

GAIN vs. INPUT/OUTPUT SIGNAL LEVEL

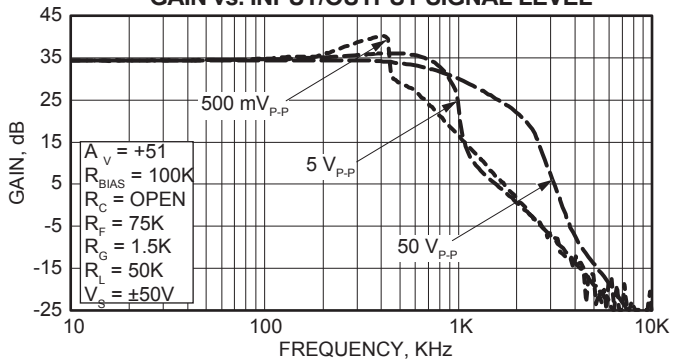

SMALL SIGNAL GAIN vs. COMPENSATION, $V_o = 5V_{P-P}$

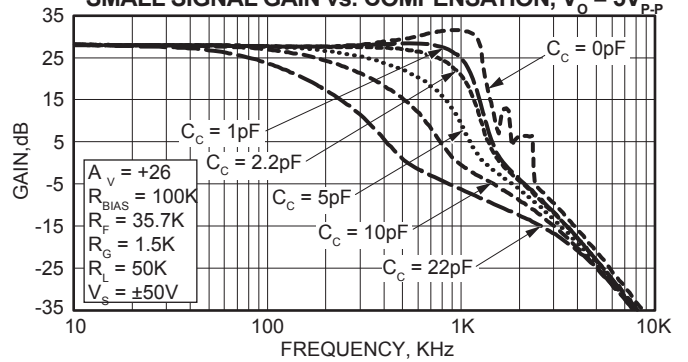

SMALL SIGNAL GAIN vs. COMPENSATION, $V_o = 500mV_{P-P}$

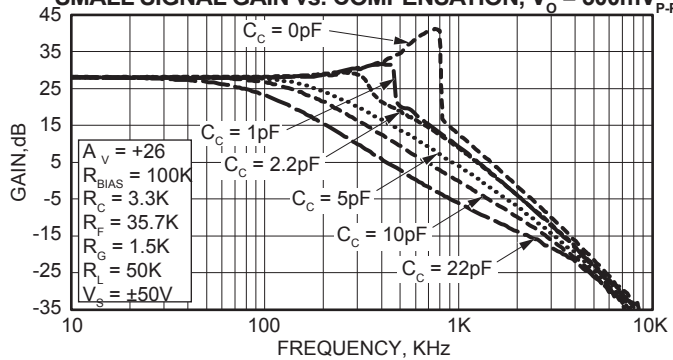

LARGE SIGNAL GAIN vs. COMPENSATION, $V_o = 50V_{P-P}$

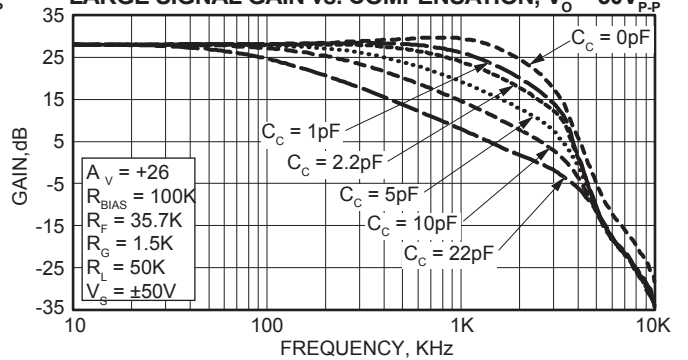

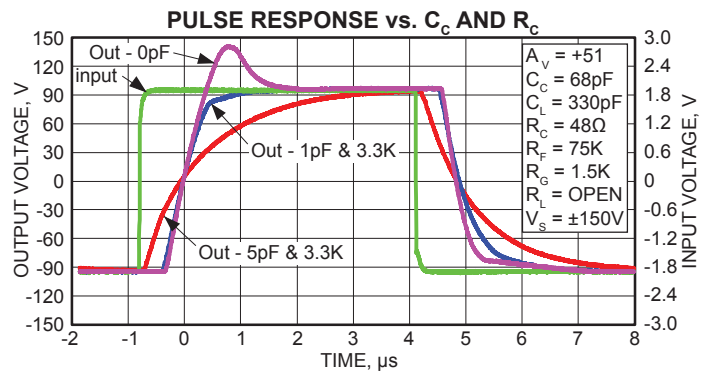
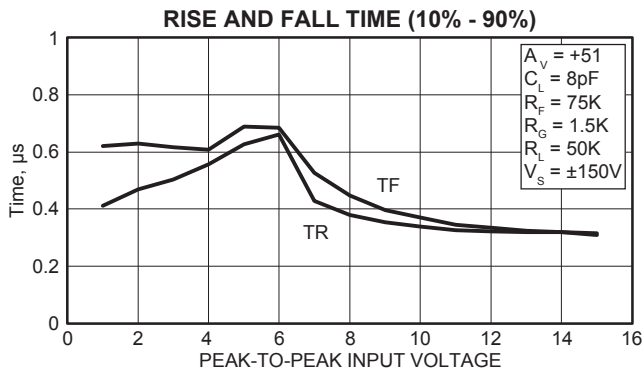
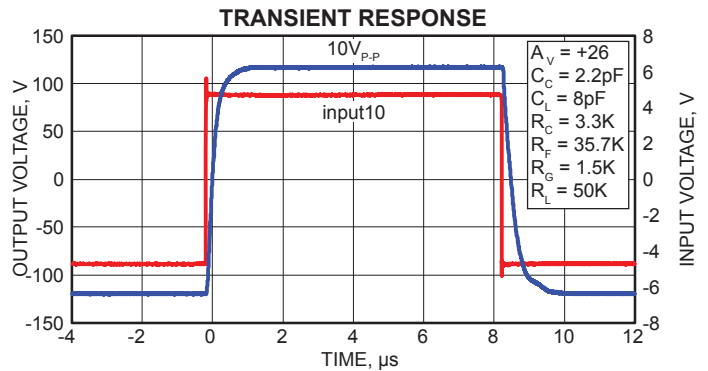
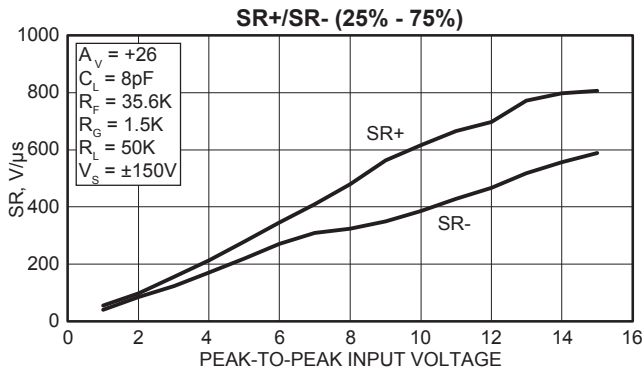
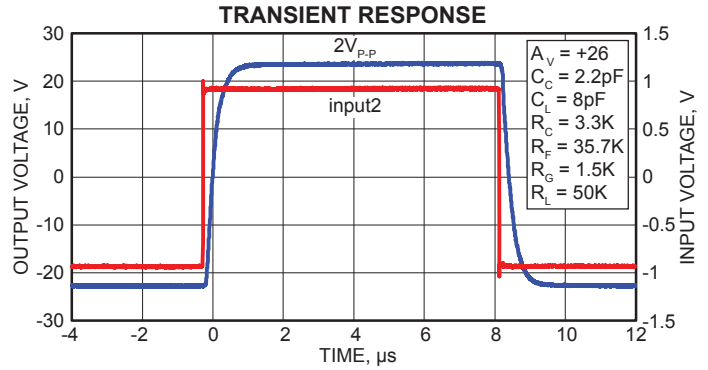
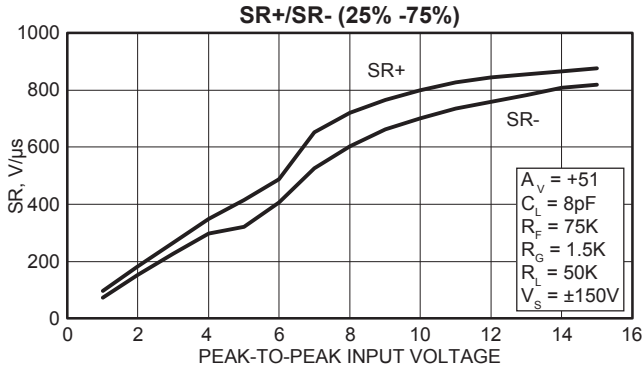
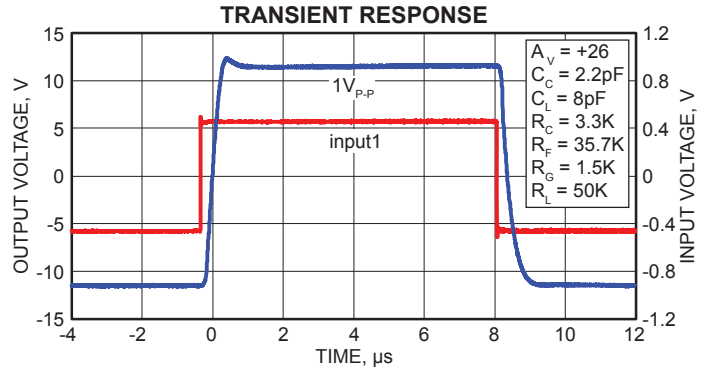
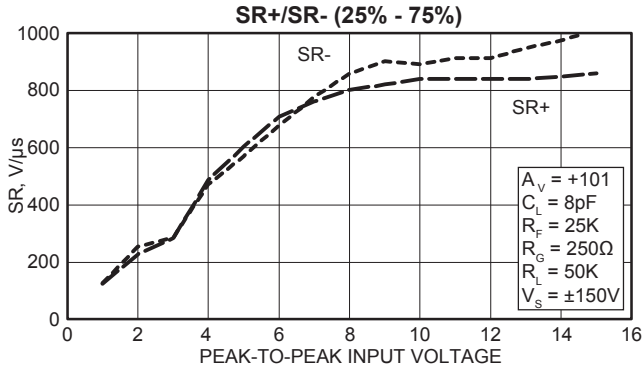

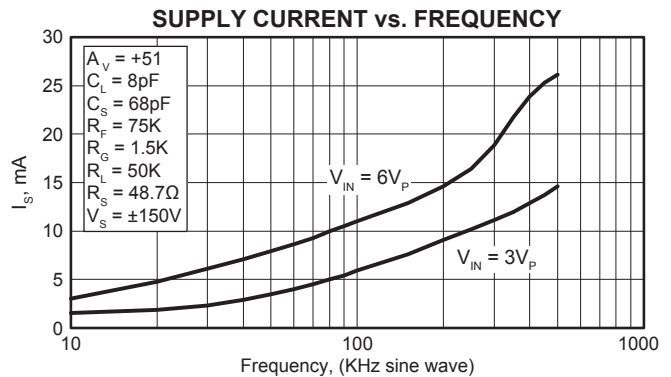
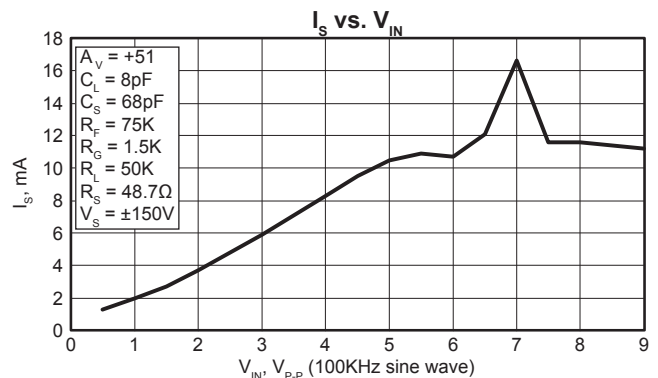
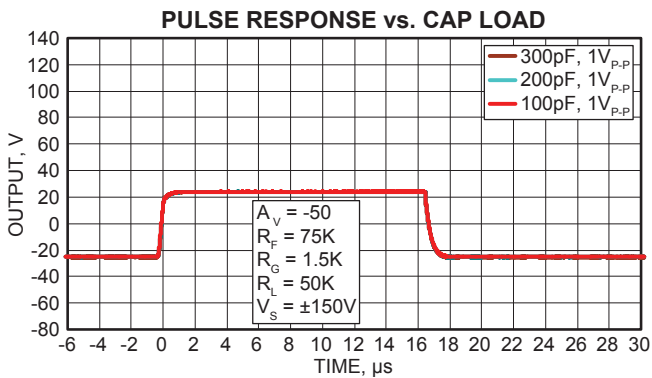
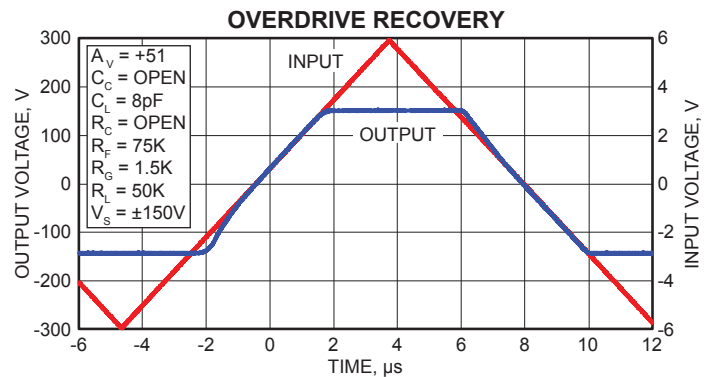
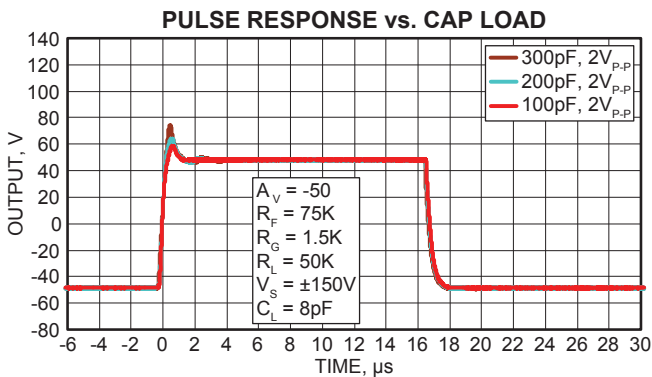
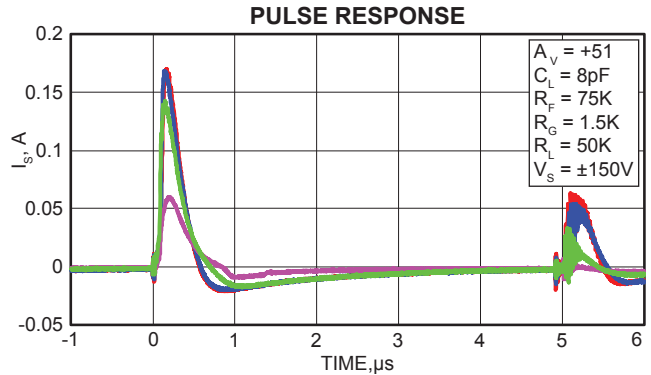
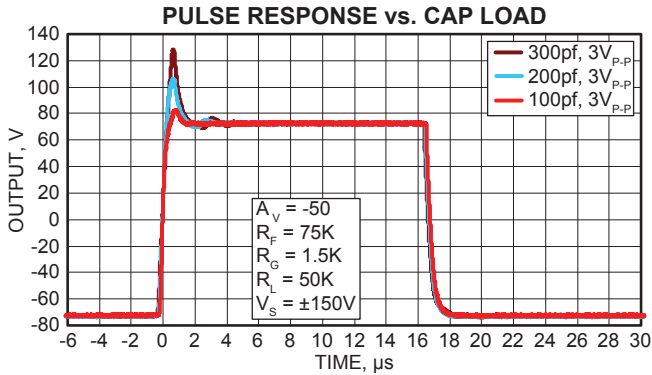

GENERAL

Please read Application note 1 “General operating considerations” which covers stability, power supplies, heat sinking, mounting, current limit, SOA interpretation, and specification interpretation. Visit www.apexanalog.com for design tools that help automate tasks such as calculations for stability, internal power dissipation, and current limit. There you will also find a complete application notes library, technical seminar workbook, and evaluation kits.

THEORY OF OPERATION

The PA78 is designed specifically as a high speed pulse amplifier. In order to achieve high slew rates with low idle current, the internal design is quite different from traditional voltage feedback amplifiers. Basic op amp behaviors like high input impedance and high open loop gain still apply. But there are some notable differences, such as signal dependent supply current, bandwidth and output impedance, among others. The impact of these differences varies depending on application performance requirements and circumstances. These different behaviors are ideal for some applications but can make designs more challenging in other circumstances.

SUPPLY CURRENT AND BYPASS CAPACITANCE

A traditional voltage feedback amplifier relies on fixed current sources in each stage to drive the parasitic capacitances of the next stage. These currents combine to define the idle or quiescent current of the amplifier. By design, these fixed currents are often the limiting parameter for slew rate and bandwidth of the amplifier. Amplifiers which are high voltage and have fast slew rates typically have high idle currents and dissipate notable power with no signal applied to the load. At the heart of the PA78 design is a signal dependent current source which strikes a new balance between supply current and dynamic performance. With small input signals, the supply current of the PA78 is very low, idling at less than 1 mA. With large transient input signals, the supply currents increase dramatically to allow the amplifier stages to respond quickly. The Pulse Response plot in the typical performance section of this datasheet describes the dynamic nature of the supply current with various input transients.

Choosing proper bypass capacitance requires careful consideration of the dynamic supply currents. High frequency ceramic capacitors of 0.1 μ F or more should be placed as close as possible to the amplifier supply pins. The inductance of the routing from the supply pins to these ceramic capacitors will limit the supply of peak current during transients, thus reducing the slew rate of the PA78. The high frequency capacitance should be supplemented by additional bypass capacitance not more than a few centimeters from the amplifier. This additional bypass can be a slower capacitor technology, such as electrolytic, and is necessary to keep the supplies stable during sustained output currents. Generally, a few microfarad is sufficient.

SMALL SIGNAL PERFORMANCE

The small signal performance plots in the typical performance section of this datasheet describe the behavior when the dynamic current sources described previously are near the idle state. The selection of compensation capacitor directly affects the open loop gain and phase performance.

Depending on the configuration of the amplifier, these plots show that the phase margin can diminish to very low levels when left uncompensated. This is due to the amount of bias current in the input stage when the part is in standby. An increase in the idle current in the output stage of the amplifier will improve phase margin for small signals although will increase the overall supply current.

Current can be injected into the output stage by adding a resistor, R_{BIAS} , between C_C and V_{S+} . The size of R_{BIAS}

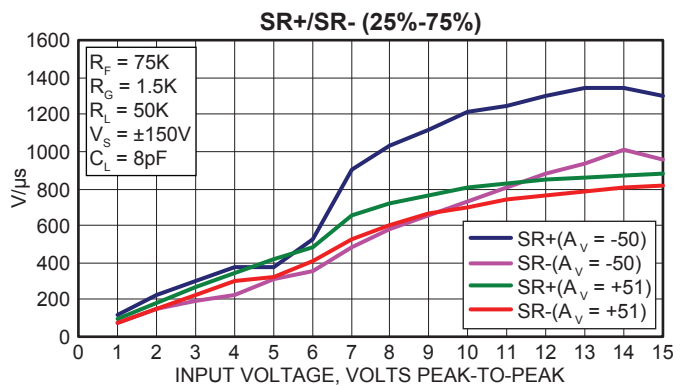
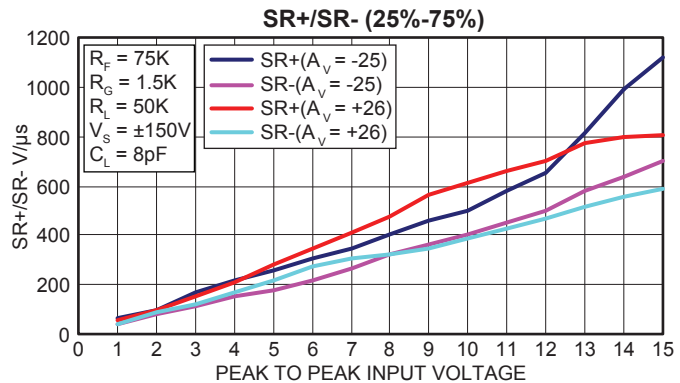

will depend upon the application but 500 μ A (50V V+ supply/100K) of added bias current shows significant improvement in the small signal phase plots. Adding this resistor has little to no impact on small signal gain or large signal performance as under these conditions the current in the input stage is elevated over its idle value. It should also be noted that connecting a resistor to the upper supply only injects a fixed current and if the upper supply is fixed and well bypassed. If the application includes variable or adjustable supplies, a current source diode could also be used. These two terminal components combine a JFET and resistor connected within the package to behave like a current source.

As a second stability measure, the PA78 is externally compensated and performance can be optimized to the application. Unlike the R_{BIAS} technique, external phase compensation maintains the low idle current but does affect the large signal response of the amplifier. Refer to the small and large signal response plots as a guide in making the tradeoffs between bandwidth and stability. Due to the unique design of the PA78, two symmetric compensation networks are required. The compensation capacitor C_c must be rated for a working voltage of the full operating supply voltage ($+V_s$ to $-V_s$). NPO capacitors are recommended to maintain the desired level of compensation over temperature.

The PA78 requires an external 33pF capacitor between C_c and $-V_s$ to prevent oscillations in the falling edge of the output. This capacitor should be rated for the full supply voltage ($+V_s$ to $-V_s$).

LARGE SIGNAL PERFORMANCE

As the amplitude of the input signal increases, the internal dynamic current sources increase the operation bandwidth of the amplifier. This unique performance is apparent in its slew rate, pulse response, and large signal performance plots. Recall the previous discussion about the relationships between signal amplitude, supply current, and slew rate. As the amplitude of the input amplitude increases from 1V_{P-P} to 15V_{P-P}, the slew rate increases from 50V/ μ s to well over 350V/ μ s.

Notice the knee in the Rise and Fall times plot, at approximately 6V_{P-P} input voltage. Beyond this point the output becomes clipped by the supply rails and the amplifier is no longer operating in a closed loop fashion. The rise and fall times become faster as the dynamic current sources are providing maximum current for slewing. The result of this amplifier architecture is that it slews fast, but allows good control of overshoot for large input signals. This can be seen clearly in the large signal Transient Response plots.

HEATSINKING AND SAFE OPERATING AREA

The MOSFET output stage of the PA78 is not limited by second breakdown considerations as in bipolar output stages. Only thermal considerations of the package and current handling capabilities limit the Safe Operating Area. The SOA plots include power dissipation limitations which are dependent upon case temperature. Keep in mind that the dynamic current sources which drive high slew rates can increase the operating temperature of the amplifier during periods of repeated slewing. The plot of supply current vs. input signal amplitude for a 100 kHz signal provides an indication of the supply current with repeated slewing conditions. This application dependent condition must be considered carefully.

The output stage is self-protected against transient flyback by the parasitic body diodes of the output stage. However, for protection against sustained high energy flyback, external, fast recovery diodes must be used.

CURRENT LIMIT

For proper operation, the current limit resistor, R_{LIM} , must be connected as shown in the external connections diagram. For maximum reliability and protection, the largest resistor value should be used. The minimum practical value for R_{LIM} is about 12 Ω . However, refer to the SOA curves for each package type to assist in selecting the optimum value for R_{LIM} in the intended application. Current limit may not protect against short circuit conditions with supply voltages over 200V.

LAYOUT CONSIDERATIONS

The PA78 is built on a dielectrically isolated process and the package tab is therefore not electrically connected to the amplifier. For high speed operation, the package tab should be connected to a stable reference to reduce capacitive coupling between amplifier nodes and the floating tab. It is often convenient to directly connect the tab to GND or one of the supply rails, but an AC connection through a 1 μ F capacitor to GND is also sufficient if a DC connection is undesirable.

Care should be taken to position the R_C / C_C compensation networks close to the amplifier compensation pins. Long loops in these paths pick up noise and increase the likelihood of LC interactions and oscillations.

The PA78DK package has a large exposed integrated copper heatslug to which the monolithic amplifier is directly attached. The solder connection of the heat slug to a 1 square inch foil area on the printed circuit board will result in improved thermal performance of 25°C/W. In order to improve the thermal performance, multiple metal layers in the printed circuit board are recommended. This may be adequate heatsinking but the large number of variables involved suggest temperature measurements be made on the top of the package. Do not allow the temperature to exceed 85°C.

The junction to ambient thermal resistance of the DK package can achieve a 19.1°C/W rating by using the PCB conditions outlined in JEDEC standard: (JESD51–5):

PCB Conditions:

PCB Layers = 4L, Copper, FR–4
PCB Dimensions = 101.6 x 114.3mm
PCB Thickness = 1.6mm

Conditions:

Power dissipation = 2 watt
Ambient Temperature = 55°C

ELECTROSTATIC DISCHARGE

Like many high performance MOSFET amplifiers, the PA78 very sensitive to damage due to electrostatic discharge (ESD). Failure to follow proper ESD handling procedures could have results ranging from reduced operating performance to catastrophic damage. Minimum proper handling includes the use of grounded wrist or shoe straps, grounded work surfaces. Ionizers directed at the work in progress can neutralize the charge build up in the work environment and are strongly recommended.

NEED TECHNICAL HELP? CONTACT APEX SUPPORT!

For all Apex Microtechnology product questions and inquiries, call toll free 800-546-2739 in North America.

For inquiries via email, please contact apex.support@apexanalog.com.

International customers can also request support by contacting their local Apex Microtechnology Sales Representative.

To find the one nearest to you, go to www.apexanalog.com

IMPORTANT NOTICE

Apex Microtechnology, Inc. has made every effort to insure the accuracy of the content contained in this document. However, the information is subject to change without notice and is provided "AS IS" without warranty of any kind (expressed or implied). Apex Microtechnology reserves the right to make changes without further notice to any specifications or products mentioned herein to improve reliability. This document is the property of Apex Microtechnology and by furnishing this information, Apex Microtechnology grants no license, expressed or implied under any patents, mask work rights, copyrights, trademarks, trade secrets or other intellectual property rights. Apex Microtechnology owns the copyrights associated with the information contained herein and gives consent for copies to be made of the information only for use within your organization with respect to Apex Microtechnology integrated circuits or other products of Apex Microtechnology. This consent does not extend to other copying such as copying for general distribution, advertising or promotional purposes, or for creating any work for resale.

APEX MICROTECHNOLOGY PRODUCTS ARE NOT DESIGNED, AUTHORIZED OR WARRANTED TO BE SUITABLE FOR USE IN PRODUCTS USED FOR LIFE SUPPORT, AUTOMOTIVE SAFETY, SECURITY DEVICES, OR OTHER CRITICAL APPLICATIONS. PRODUCTS IN SUCH APPLICATIONS ARE UNDERSTOOD TO BE FULLY AT THE CUSTOMER OR THE CUSTOMER'S RISK.

Apex Microtechnology, Apex and Apex Precision Power are trademarks of Apex Microtechnology, Inc. All other corporate names noted herein may be trademarks of their respective holders.