

SECTION A-A
(VIEW FROM FRONT)

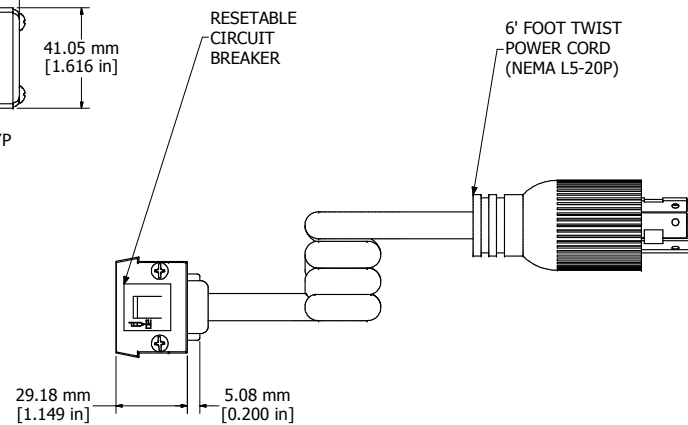

ASSEMBLY - VIEW FROM END

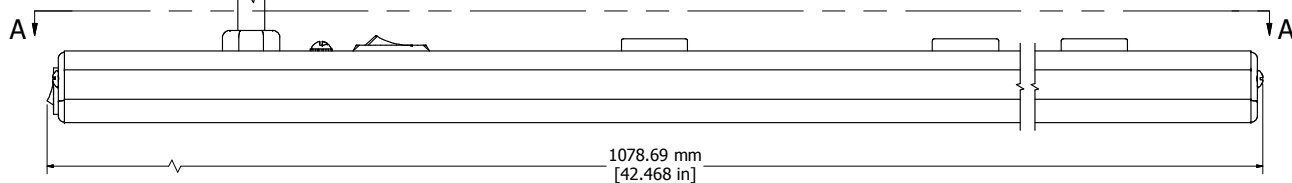

ASSEMBLY - VIEW FROM SIDE

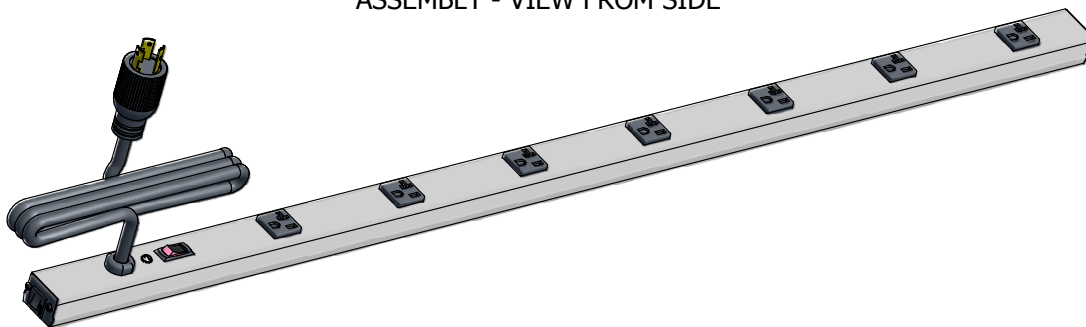

ISOMETRIC VIEW

1589H42C1
Finish - Case - Anodized Aluminum Extrusion
Ends - ABS Plastic
Rated - 125 VAC, 60 Hz, 20 Amps
Approvals - CSA Certified Standards C22.2 (No. 21-95, 42-99) - UL Listed Standard UL1363
Cord Length
1589H42C1 - 6' Foot Twist Power Cord (NEMA L5-20P)
1589H42D1 - 15' Foot Twist Power Cord (NEMA L5-20P)
Accessories Included
Mounting Bracket Kit with Hardware

HAMMOND MANUFACTURING™

1589H42C1

www.hammondmfg.com