

## Top view LEDs 45-21UMC/XXXXXXXX/TR8



### Features

- Top View White LEDs
- Lead frame package with individual 2 pins
- Wide viewing angle
- Soldering methods: IR reflow soldering Pb-free
- The product itself will remain within RoHS compliant version.

### Applications

- LCD back light
- Mobile phones
- Indicators.
- Illuminations.
- Switch lights.

## Device Selection Guide

Chip Materials	Emitted Color	Resin Color
InGaN	White	Yellowish

**45-21UMC/XXXXXXXX/TR8**

45-21	-	UM	C	-	XX	XX	XX	X	-	T	R	8
1					2	3	4	5		6	7	8

The product name is designated as below:

1.	Product type
2.	C.I.E Range Code Of Group
3.	Iv Range Code Of Group
4.	Forward Voltage Spec. Setup
5.	Test Of Electric Current
6.	Package Quantity
7.	Packing method
8.	Forming types

**Absolute Maximum Ratings (Ta=25°C)**

Parameter	Symbol	Rating	Unit
Reverse Voltage	$V_R$	5	V
Forward Current	$I_F$	30	mA
Power Dissipation	$P_d$	110	mW
Operating Temperature	$T_{opr}$	-40 ~ +85	°C
Storage Temperature	$T_{stg}$	-40 ~ +90	°C
Soldering Temperature	$T_{sol}$	Reflow Soldering : 260 °C for 10 sec. Hand Soldering : 350 °C for 3 sec.	

**Electro-Optical Characteristics (Ta=25°C)**

Parameter	Symbol	Min.	Typ.	Max.	Unit	Condition
Luminous Intensity	$I_v$	1200	-----	2200	mcd	$I_F=20mA$
Viewing Angle	$2\theta_{1/2}$	-----	120	-----	deg	$I_F=20mA$
Forward Voltage	$V_F$	2.8	----	3.55	V	$I_F=20mA$
Reverse Current	$I_R$	-----	-----	50	$\mu A$	$V_R=5V$

Note:

1. Tolerance of Luminous Intensity:  $\pm 11\%$
2. Tolerance of Dominant Wavelength:  $\pm 1nm$
3. Tolerance of Forward Voltage:  $\pm 0.1V$

**Bin Range of Luminous Intensity**

Bin Code	Min.	Max.	Unit	Condition
22	1200	1250		
23	1250	1300		
24	1300	1350		
25	1350	1400		
26	1400	1450		
27	1450	1500		
28	1500	1550		
29	1550	1600		
30	1600	1650		
31	1650	1700		
32	1700	1750	mcd	I <sub>F</sub> =20mA
33	1750	1800		
34	1800	1850		
35	1850	1900		
36	1900	1950		
37	1950	2000		
38	2000	2050		
39	2050	2100		
40	2100	2150		
41	2150	2200		

Note:  
 Tolerance of Luminous Intensity: ±11%

### Bin Range of Forward Voltage

Group								Bin Code	Min.	Max.	Unit	Condition
0	1	2	3	4	5	6	7	6-1	2.95	3.05	V	I <sub>F</sub> =20mA
								6-2	3.05	3.15		
	8	7-1	3.15	3.25								
		7-2	3.25	3.35								
		8-1	3.35	3.45								
		8-2	3.45	3.55								

Group	Bin Code	Min.	Max.	Unit	Condition
9	6-11	3.00	3.05	V	I <sub>F</sub> =20mA
	6-2	3.05	3.15		
	7-1	3.15	3.25		
	7-2	3.25	3.35		
	8-1	3.35	3.45		
	8-11	3.45	3.50		

Group								Bin Code	Min	Max	Unit	Condition	
C	R	L	N	B	K	H	E	F	5-1-3	2.80	2.90	V	I <sub>F</sub> =20mA
									5-2-3	2.90	3.00		
									6-1-3	3.00	3.10		
									6-2-3	3.10	3.20		
	7-1-3	3.20	3.30										
	7-2-3	3.30	3.40										
	8-1-3	3.40	3.50										

Note:  
Tolerance of Forward Voltage: ± 0.05V

**Bin Range of Chromaticity Coordinates Block (IF=20mA)**

Group	Range	I <sub>v</sub> Rank*	Group	Range	I <sub>v</sub> Rank*
01	B5-1,B5-2,B5-3,B5-4	38	26	A0-1, A0-3, A0-4	36
02	B5-1~B5-4,A0-2,A0-4	38	27	A0-1, A0-2, A0-3	36
07	B5-1,B5-3,A0-4	37	28	A0-2, A0-3, A0-4	36
08	A0-2,A0-3,A0-4	36	29	A0-2, B5-1, B5-3	37
09	A0-1,A0-3,A0+4	35	30	A0-2, A0-4, B5-3	37
10	A0+1, A0+2, A0-1	35	31	B5-1, A0-2, A0-4	37
11	A0+2, A0-1, A0-2	36	32	B5-1, B5-3, A0-4	37
12	A0-1, A0-2, B5-1	37	33	B5-1, B5-2, B5-4	38
13	A0-2, B5-1, B5-2	38	34	B5-1, B5-3, B5-4	38
14	A0+3, A0+4, A0-3	35	35	B5-1, B5-2, B5-3	38
15	A0+4, A0-3, A0-4	36	36	B5-2, B5-3, B5-4	38
16	A0-3, A0-4, B5-3	37	37	B5-1, B5-2	38
17	A0-4, B5-3, B5-4	38	38	A0-1, A0-3	35
18	A0+1, A0+2, A0+4	34	39	A0-2, A0-4, B5-1, B5-3	37
19	A0+1, A0+3, A0+4	34	40	A0-3,A0-4	36
20	A0+1, A0+2, A0+3	34	41	A0-4, B5-1, B5-3, B5-4	38
21	A0+2, A0-1, A0-3	35	42	A0-4, B5-3	37
22	A0+2, A0+4, A0-3	35	43	B5-2,B5-4	38
23	A0-1, A0+2, A0+4	35	44	A0-1, A0-2, A-4, B5-3	37
24	A0-1, A0-3, A0+4	35	45	B5-1, B5-3	37
25	A0-1, A0-2, A0-4	36	46	A0+1, A0+2	34

**Bin Range of Chromaticity Coordinates Block (If=20mA)**

Group	Range	I <sub>v</sub> Rank*	Group	Range	I <sub>v</sub> Rank*
47	B6-1, B6-2, B6-3, B6-4	40	67	A0+2, A0-1, A0-3, A0-4	36
48	B6-2, B6-4	40	68	A0+4-R, A0-3, A0-4-L	35
49	A0-2, B5-1, B5-3, B5-4	38	69	B5-1, 2, 3, 4 subdivision	38
50	A0-1~A0-4, B5-1~B5-4	38	70	A0+4-2, A0+4-4, A0-3 subdivision, A0-4-1, A0-4-3	35
51	A0-1, A0-3, A0-4-1, A0-4-3	36	71	A0-3 non-division, A0-4 subdivision	36
52	A0+3, A0+4	34	72	A0+1~+4, A0-1~+4, B5-1~+4, B6-1~+4	40
53	B6-1, B6-2, B6-3	40	73	A0-4, B5-1, B5-3 subdivision	37
54	B6-1, B6-3	40	74	A0-4	36
55	B5-2, B5-4, B6-1, B6-3	39	75	B5-2	38
56	B5-2, B6-1	39	76	A0-1~A0-4; B5-1~B5-4	38
57	A0-2, B5-1	37	77	B5-3, B5-4 subdivision	38
58	A0-1, A0-2	36	78	A0-3, A0+4	35
59	A0-1, A0-2, A0-3, A0-4, B5-1	37	79	B5-1, B5-2, B5-3, B5-4, B6-3 subdivision	40
60	A0+2, A0+4, A0-1, A0-3	35	80	A0-3, A0-4, B5-3 subdivision	38
61	B5-2-1~B5-2-4, 6-1-1~B6-1-4	39	81	A0-3, A0-4, B5-3 divide into 8 parts (each)	38
62	B5-3, B5-4	39	82	A0-1~A0-4, A0+2, A0+4	35
63	A0-1~A0-4, B5-1, B5-3	38	83	B5-4, B6-3	40
64	A0-2, A0-4	37	84	B6-1, B6-2	40
65	A0-2, A0-3, A0-4, B5-3	36	85	A0-4, B5-2, B5-3, B5-4	38
66	A0-3-1~A0-3-4, A0-4-1~A0-4-4	36	86	B5 & B6 subdivision	40

**Bin Range of Chromaticity Coordinates Block (I<sub>F</sub>=20mA)**

Group	Range	I <sub>V</sub> Rank*	Group	Range	I <sub>V</sub> Rank*
87	B5-3	38	99	B5-2,B5-4,B6-1,B6-3 Sub-division	40
88	B5-2-3/ B5-2-4/ B5-4 subdivision/ B6-1-2/ B6-1-3/ B6-1-4/ B6-3 subdivision/ B6-4-1	40	A	A0+1, A0+2, A0+3, A0+4	35
89	A0-4, B5-3 subdivision	38	B	A0+4, A0-3, A0-4	35
90	A0-4-R, B5-3 subdivision	38	C	A0-1,A0-2,A0-3,A0-4	36
91	A0-3-2, A0-3-4, A0-4 subdivision, B5-3-1,B5-3-3	38	C0	C0-1,C0-2,C0-3,C0-4	41
92	B5-2, B6-1-1, B6-4-1, B5-3-2, B6-1-3, B6-4-3, B6-1-4, B6-4-4, B5-4, B6-3	40	A1	A0+1,A0+2sub-division	34
93	A0+4, A0-3 subdivision	35	A2	B6-2,B6-3,B6-4	40
94	A0-4-R, B5-3, B5-4 subdivision	38	A3	B5-2,B5-4,B6-3	40
95	B5-4, B6-3 subdivision	40	A4	A0-1,A0-2,A0-4 Sub-division	36
96	A0-4, B5-3, B5-4 subdivision	38	A5	A0-2,A0-4,B5-3 Sub-division	38
97	B6-1,B6-3,B6-4	40	A6	A0-4-R,B5-3,B5-4-L	38
98	A0+1~A0+4; A0-1~A0-4; B5-1~B5-4;B6-2~B6-4; NA0-3~NB6-3	40	A7	B6-2,B6-4,C0-1,C0-3	41



### The C.I.E. 1931 Chromaticity Diagram

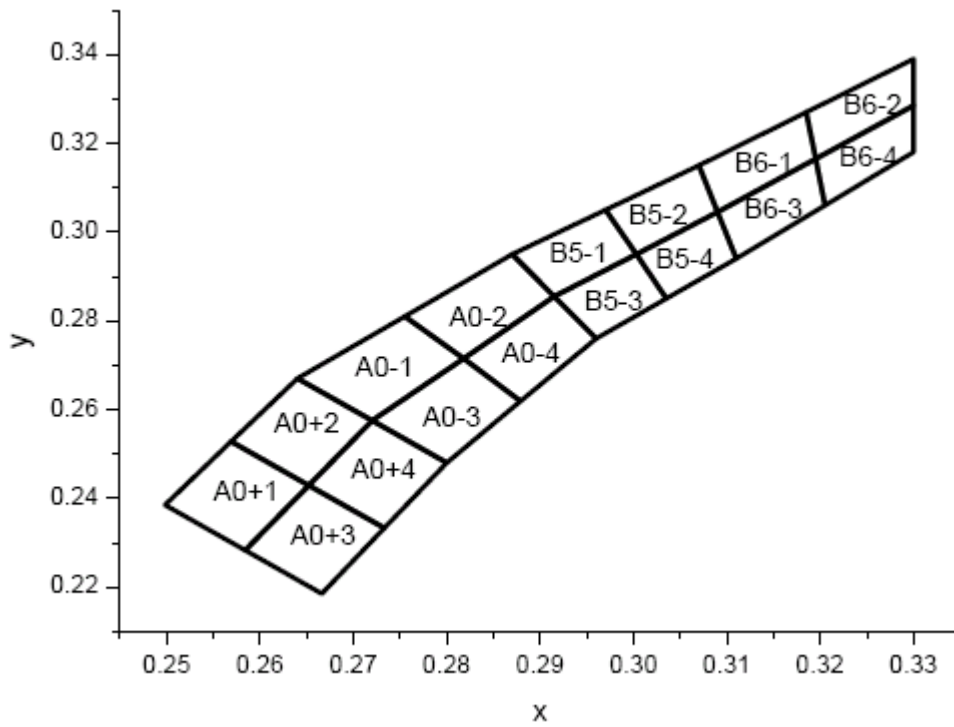

**Chromaticity Coordinates of Bin Code**

Bin Code	CIE_x	CIE_y	Bin Code	CIE_x	CIE_y
A0+1	0.2569	0.2528	A0+3	0.2652	0.2429
	0.2498	0.2385		0.2584	0.2283
	0.2584	0.2283		0.2666	0.2185
	0.2652	0.2429		0.2733	0.2333
A0+2	0.2640	0.2670	A0+4	0.2720	0.2575
	0.2569	0.2528		0.2652	0.2429
	0.2652	0.2429		0.2733	0.2333
	0.2720	0.2575		0.2800	0.2480
A0-1	0.2720	0.2575	A0-3	0.2800	0.2480
	0.2640	0.2670		0.2720	0.2575
	0.2755	0.2810		0.2818	0.2715
	0.2818	0.2715		0.2879	0.2619
A0-2	0.2818	0.2715	A0-4	0.2879	0.2619
	0.2755	0.2810		0.2818	0.2715
	0.2870	0.2950		0.2915	0.2855
	0.2915	0.2855		0.2960	0.2760

**Chromaticity Coordinates of Bin Code**

Bin Code	CIE_x	CIE_y	Bin Code	CIE_x	CIE_y
B5-1	0.2915	0.2855	B5-3	0.2960	0.2760
	0.2870	0.2950		0.2915	0.2855
	0.2970	0.3050		0.3003	0.2950
	0.3003	0.2950		0.3035	0.2850
B5-2	0.3003	0.2950	B5-4	0.3035	0.2850
	0.2970	0.3050		0.3003	0.2950
	0.3070	0.3150		0.3090	0.3045
	0.3090	0.3045		0.3110	0.2940
B6-1	0.3090	0.3045	B6-3	0.3110	0.2940
	0.3070	0.3150		0.3090	0.3045
	0.3185	0.3270		0.3195	0.3165
	0.3195	0.3165		0.3205	0.3060
B6-2	0.3195	0.3165	B6-4	0.3205	0.3060
	0.3185	0.3270		0.3195	0.3165
	0.3300	0.3390		0.3300	0.3285
	0.3300	0.3285		0.3300	0.3180

## Typical Electro-Optical Characteristics Curves

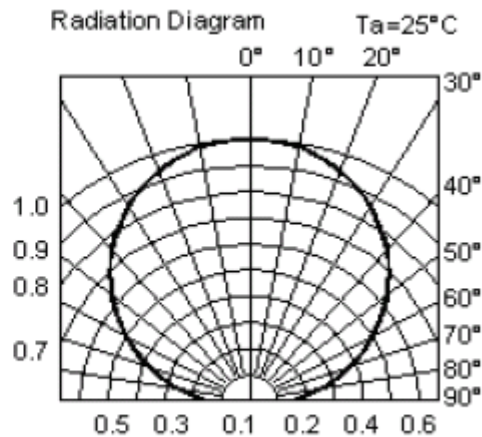
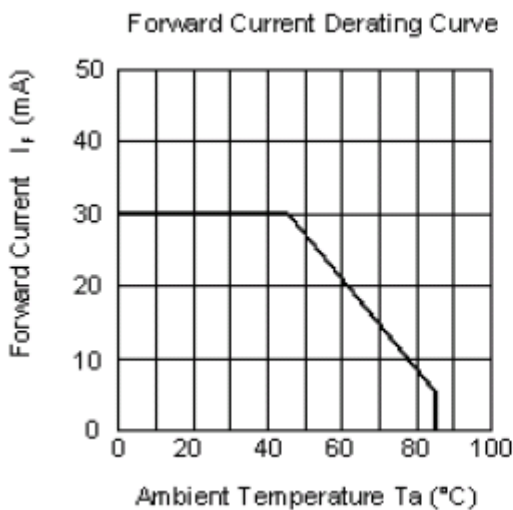
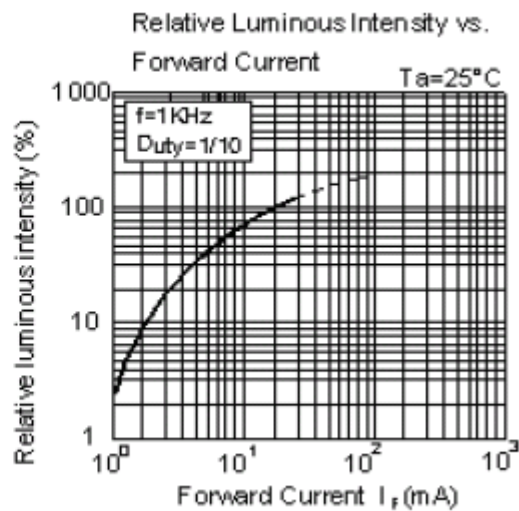
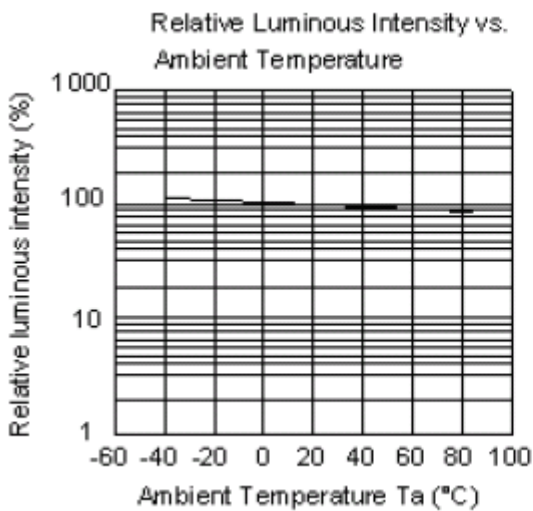
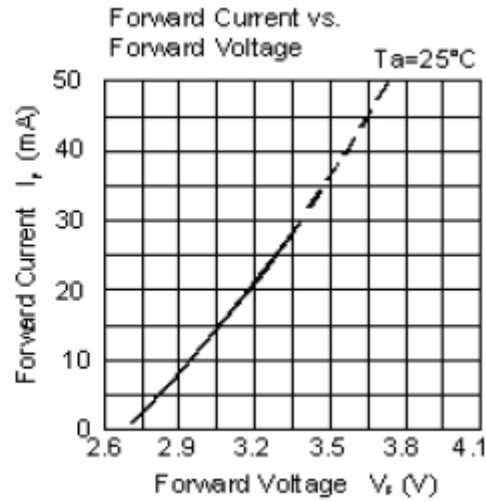
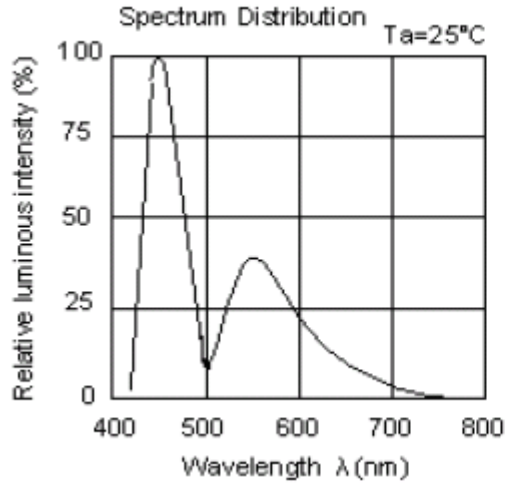

### Package Dimension

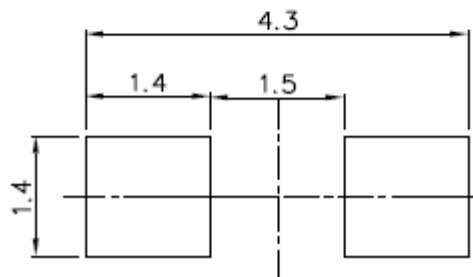
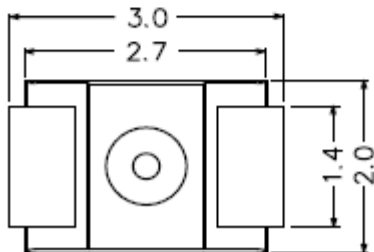
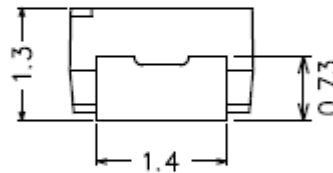
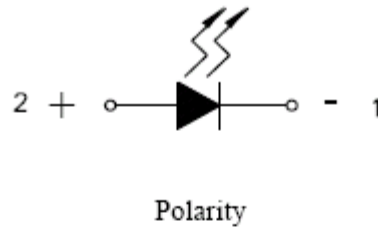
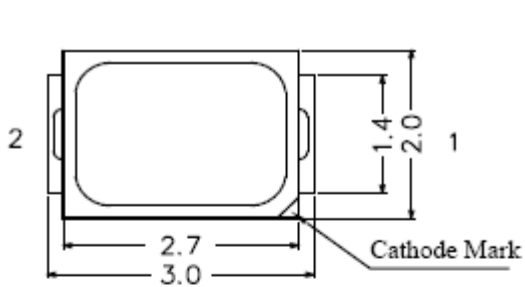

Recommended soldering pad design

Note: Tolerances unless mentioned  $\pm 0.1$ mm. Unit = mm

## Moisture Resistant Packing Materials

### Label Explanation



- CPN: Customer's Product Number
- P/N: Product Number
- QTY: Packing Quantity
- CAT: Luminous Intensity Rank
- HUE: Dom. Wavelength Rank
- REF: Forward Voltage Rank
- LOT No: Lot Number

### Reel Dimensions

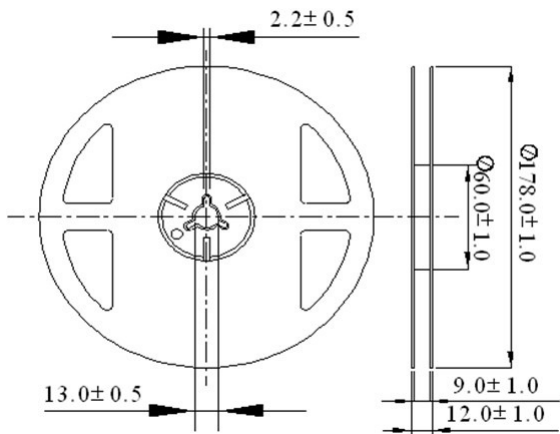

### Carrier Tape Dimensions: Loaded Quantity 2000 pcs Per Reel

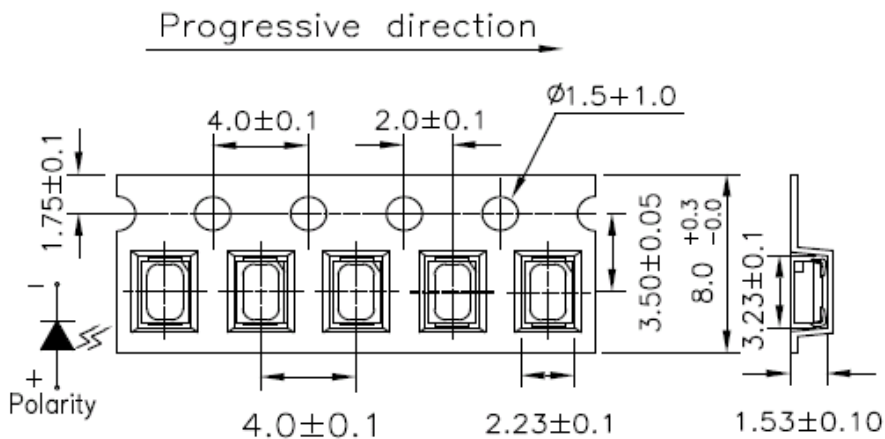

Note: Tolerances unless mentioned  $\pm 0.1$ mm. Unit = mm

**Moisture Resistant Packing Process**

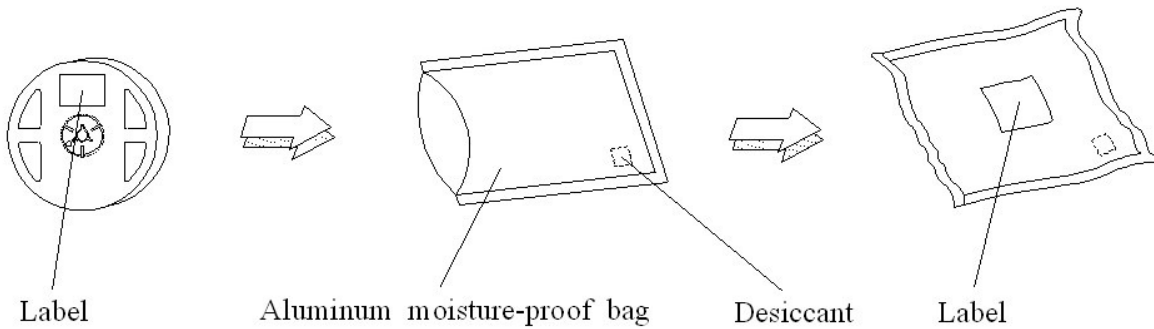

Note: Tolerances unless mentioned  $\pm 0.1\text{mm}$ . Unit = mm

**Precautions for Use**

1. Soldering Condition

1.1 (A) Maximum Body Case Temperature Profile for evaluation of Reflow Profile

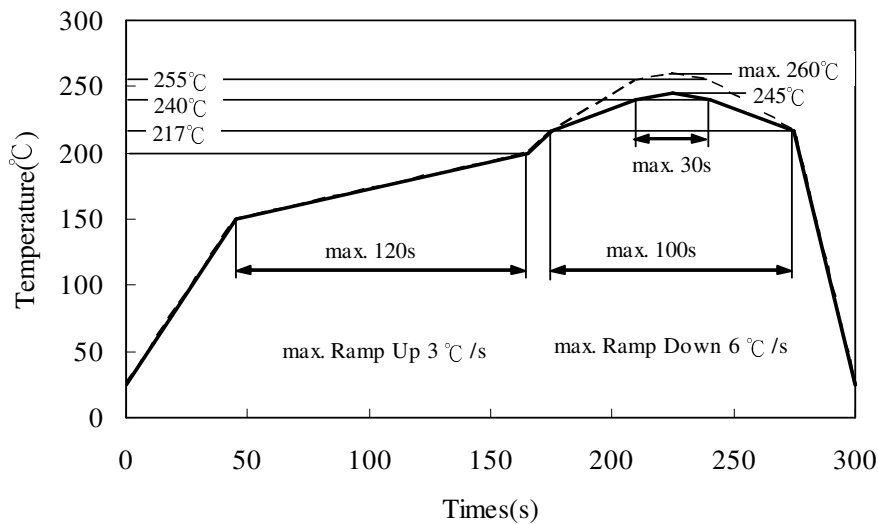

(B) recommend soldering pad

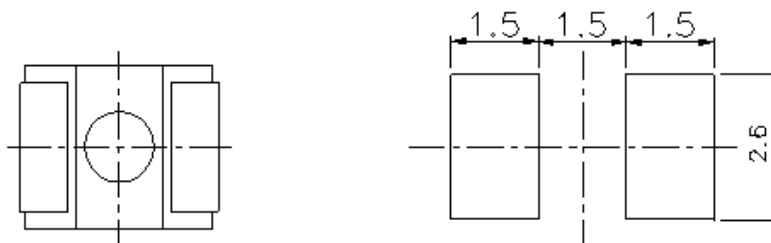

Note: Tolerances unless mentioned  $\pm 0.1\text{mm}$ . Unit = mm

## 2. Current limiting

A resistor should be used to limit current spikes that can be caused by voltage fluctuations. Otherwise damage could occur.

## 3. Storage

3.1 Moisture proof bag should only be opened immediately prior to usage.

3.2 Environment should be less than 30°C and 60% RH when moisture proof bag is opened.

3.3 After opening the package MSL Conditions stated on page 1 of this spec should not be exceeded.

3.4 If the moisture sensitivity card indicates higher than acceptable moisture, the component should be baked at min. 60deg +/-5deg for 24 hours.

## 4. Iron Soldering

Hand soldering is not recommended for regular production. These guidelines are for rework only. Soldering iron tip should contact each terminal no more than 3 sec at 350°C, using soldering iron with nominal power less than 25W. Allow min. 2 sec. between soldering intervals.

## 5. Usage

Do not exceed the values given in this specification.

## Application Restrictions

High reliability applications such as military/aerospace, automotive safety/security systems, and medical equipment may require different product. If you have any concerns, please contact Everlight before using this product in your application. This specification guarantees the quality and performance of the product as an individual component. Do not use this product beyond the specification described in this document.