

High Power LED Series Chip on Board

LC019B - Gen3

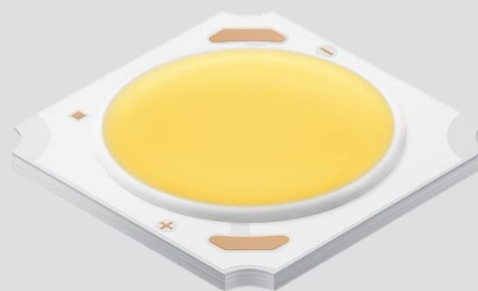

High efficacy COB LED package,
well-suited for use in spotlight applications

Features & Benefits

- Chip on Board (COB) solution makes it easy to design in
- Simple assembly reduces manufacturing cost
- Low thermal resistance
- InGaN/GaN MQW LED with long time reliability
- Completed 6,000 hours of LM-80 Testing

Applications

- Spotlight / Downlight
- LED Retrofit Bulbs
- Outdoor Illumination



Table of Contents

1.	Characteristics	-----	3
2.	Product Code Information	-----	5
3.	Typical Characteristics Graphs	-----	10
4.	Outline Drawing & Dimension	-----	14
5.	Reliability Test Items & Conditions	-----	15
6.	Label Structure	-----	16
7.	Packing Structure	-----	17
8.	Precautions in Handling & Use	-----	19

1. Characteristics

a) Absolute Maximum Rating

Item	Symbol	Rating	Unit	Condition
Ambient / Operating Temperature	T_a	-40 ~ +105	°C	-
Storage Temperature	T_{stg}	-40 ~ +120	°C	-
LED Junction Temperature	T_j	150	°C	-
Case Temperature	T_c	105	°C	*Note
Forward Current	I_F	980	mA	-
Power Dissipation	P_D	36.3	W	-
ESD (HBM)	-	±2	kV	-
ESD (MM)	-	±0.5	kV	-

b) Electro-optical Characteristics ($I_F = 540 \text{ mA}$, $T_c = 25 \text{ °C}$)

Item	Unit	Rank	Min.	Typ.	Max.
Forward Voltage (V_F)	V	YH	32.5	35.5	38.5
Color Rendering Index (R_a)	-	5	80	-	-
		7	90	-	-
Thermal Resistance (junction to chip point)	°C/W		-	1.5	-
Beam Angle	°		-	115	-
Nominal Power	W			19.2	
Eye Protection		Risk 1	-		-

Notes:

- 1) The COB is tested in pulsed condition at rated test current (10 ms pulse width) and rated temperature ($T_j = T_c = T_a = 25 \text{ °C}$)
- 2) Samsung maintains measurement tolerance of: forward voltage = $\pm 5 \%$, CRI = ± 1
- 3) Refer to the derating curve, '3. Typical Characteristics Graph' designed within the range

c) Luminous Flux Characteristics ($I_F = 540 \text{ mA}$)

CRI (R_a)	Nominal CCT (K)	Flux Rank	Flux Bin	Sorting ¹⁾ @ $T_c = 25 \text{ }^\circ\text{C}$ (lm)		Calculated Flux ²⁾ @ $T_c = 85 \text{ }^\circ\text{C}$ (lm)		
				Min.	Max.	Min.	Max.	
80	2700	B3	25	2650	2813	2412	2560	
			26	2813	3034	2560	2761	
	3000	B3	25	2819	2992	2565	2723	
			26	2992	3227	2723	2937	
	3500	B3	24	2725	2904	2480	2643	
			25	2904	3082	2643	2805	
			26	3082	3319	2805	3020	
	4000	B3	24	2805	2988	2553	2719	
			25	2988	3172	2719	2887	
			26	3172	3420	2887	3112	
	5000	B3	24	2831	3016	2576	2745	
			25	3016	3202	2745	2914	
			26	3202	3451	2914	3140	
	5700	B3	24	2831	3016	2576	2745	
			25	3016	3202	2745	2914	
			26	3202	3451	2914	3140	
	90	2700	B3	23	2084	2251	1896	2048
				24	2251	2481	2048	2258
25				2481	2698	2258	2455	
3000		B3	23	2127	2297	1936	2090	
			24	2297	2527	2090	2300	
			25	2527	2759	2300	2511	
3500		B3	23	2191	2366	1994	2153	
			24	2366	2596	2153	2362	
			25	2596	2830	2362	2575	
4000		B3	23	2254	2435	2051	2216	
			24	2435	2665	2216	2425	
			25	2665	2901	2425	2640	

Notes:

- 1) The COB is tested in pulsed condition at rated test current (10 ms pulse width) and rated temperature ($T_j = T_c = T_a = 25 \text{ }^\circ\text{C}$)
- 2) Calculated flux values are for reference only
- 3) Samsung maintains measurement tolerance of: luminous flux = $\pm 7 \%$, CRI = ± 1

2. Product Code Information

1	2	3	4	5	6	7	8	9	10	11	12	13	14	15	16	17	18
S	P	H	C	W	1	H	D	N	B	2	5	Y	H	R	T	B	3

Digit	PKG Information	Code	Specification
1 2 3	Samsung Package High Power	SPH	
4 5	Color	WW CW	Warm White (T/U/V/W Ranks) Cool White (Q/R Ranks)
6	Product Version	1	
7 8	Form Factor	HD	COB
9	Lens Type	N	No lens
10	Internal Code	B	LC019
11	Chip Type	2	
12	CRI & Sorting Temperature	5 7	Min. 80 25 °C Min. 90
13 14	Forward Voltage (V)	YH	32.5~38.5
15	CCT (K)	W V U T R Q	2700 K WA, WB (MacAdam Ellipse) 3000 K VA, VB (MacAdam Ellipse) VW, VX, VY, VZ (ANSI bin) 3500 K UA, UB (MacAdam Ellipse) 4000 K TA, TB (MacAdam Ellipse) TW, TX, TY, TZ (ANSI bin) 5000 K RA (MacAdam Ellipse) RW, RX, RY, RZ (ANSI bin) 5700 K QW, QX, QY, QZ (ANSI bin)
16	MacAdam / ANSI	2 3 T	MacAdam 2-step MacAdam 3-step ANSI bin
17 18	Luminous Flux	B3	Bin Code: 24, 25, 26 (80 CRI) 23, 24, 25 (90 CRI);

a) Binning Structure ($I_F = 540 \text{ mA}$, $T_c = 25 \text{ }^\circ\text{C}$)

CRI (R _a)	Nominal	Product Code	V _F	Color	Chrom.	Flux	Flux	Flux Range	
Min.	CCT (K)		Rank	Rank	Bin	Rank	Bin	(Φ _v , lm)	
80	2700	SPHWW1HDNB25YHW2B3	YH	W2	WB	B3	25	2650 ~ 2813	
							26	2813 ~ 3034	
		SPHWW1HDNB25YHW3B3	YH	W3	WA, WB	B3	25	2650 ~ 2813	
							26	2813 ~ 3034	
	3000	SPHWW1HDNB25YHV2B3	YH	V2	VB	B3	25	2819 ~ 2992	
							26	2992 ~ 3227	
		SPHWW1HDNB25YHV3B3	YH	V3	VA, VB	B3	25	2819 ~ 2992	
							26	2992 ~ 3227	
	3500	SPHWW1HDNB25YHU2B3	YH	U2	UB	B3	24	2725 ~ 2904	
							25	2904 ~ 3082	
		SPHWW1HDNB25YHU3B3	YH	U3	UA, UB	B3	26	3082 ~ 3319	
							24	2725 ~ 2904	
	4000	SPHWW1HDNB25YHT2B3	YH	T2	TB	B3	25	2988 ~ 3172	
							26	3172 ~ 3420	
		SPHWW1HDNB25YHT3B3	YH	T3	TA, TB	B3	24	2805 ~ 2988	
							25	2988 ~ 3172	
	5000	SPHCW1HDNB25YHR3B3	YH	R3	RA	B3	26	3172 ~ 3420	
							24	2831 ~ 3016	
		SPHCW1HDNB25YHRTB3	YH	RT	RW, RX, RY, RZ	B3	25	3016 ~ 3202	
							26	3202 ~ 3451	
	5700	SPHCW1HDNB25YHQT B3	YH	QT	QW, QX, QY, QZ	B3	24	2831 ~ 3016	
							25	3016 ~ 3202	
								26	3202 ~ 3451

a) Binning Structure ($I_F = 540 \text{ mA}$, $T_c = 25 \text{ }^\circ\text{C}$)

CRI (R_a) Min.	Nominal CCT (K)	Product Code	V_F Rank	Color Rank	Chrom. Bin	Flux Rank	Flux Bin	Flux Range (Φ_v , lm)
90	2700	SPHWW1HDNB27YHW2B3	YH	W2	WB	B3	23	2084 ~ 2251
							24	2251 ~ 2481
							25	2481 ~ 2698
		SPHWW1HDNB27YHW3B3	YH	W3	WA, WB	B3	23	2084 ~ 2251
							24	2251 ~ 2481
							25	2481 ~ 2698
	3000	SPHWW1HDNB27YHV2B3	YH	V2	VB	B3	23	2127 ~ 2297
							24	2297 ~ 2527
							25	2527 ~ 2759
		SPHWW1HDNB27YHV3B3	YH	V3	VA, VB	B3	23	2127 ~ 2297
							24	2297 ~ 2527
							25	2527 ~ 2759
	3500	SPHWW1HDNB27YHU2B3	YH	U2	UB	B3	23	2191 ~ 2366
							24	2366 ~ 2596
							25	2596 ~ 2830
		SPHWW1HDNB27YHU3B3	YH	U3	UA, UB	B3	23	2191 ~ 2366
							24	2366 ~ 2596
							25	2596 ~ 2830
	4000	SPHWW1HDNB27YHT2B3	YH	T2	TB	B3	23	2254 ~ 2435
							24	2435 ~ 2665
							25	2665 ~ 2901
		SPHWW1HDNB27YHT3B3	YH	T3	TA, TB	B3	23	2254 ~ 2435
							24	2435 ~ 2665
							25	2665 ~ 2901

b) Chromaticity Region & Coordinates ($I_F = 540 \text{ mA}$, $T_c = 25 \text{ }^\circ\text{C}$)

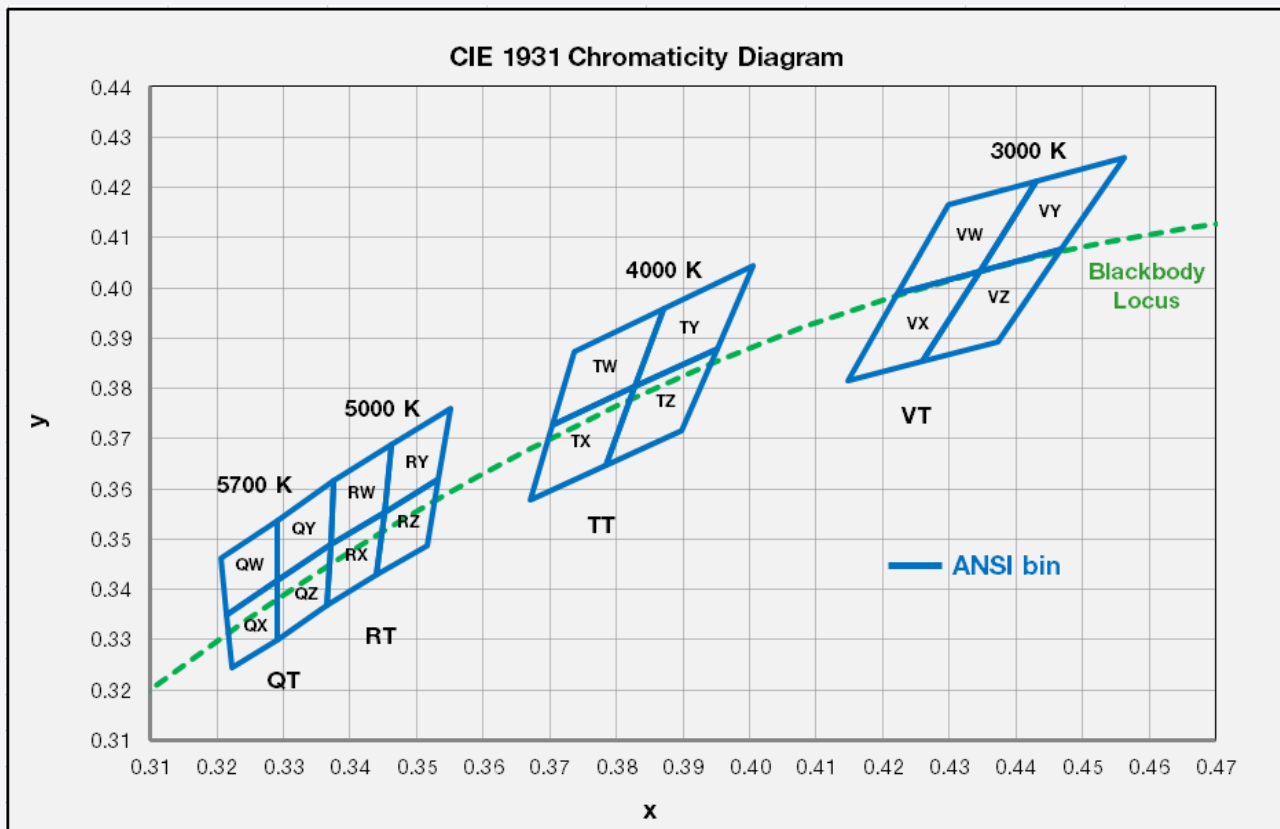

Region	CIE x	CIE y	Region	CIE x	CIE y
V rank (3000 K)					
VW	0.4223	0.399	VY	0.4345	0.4033
	0.4345	0.4033		0.4468	0.4077
	0.4431	0.4213		0.4562	0.4260
	0.4299	0.4165		0.4431	0.4213
VX	0.4223	0.399	VZ	0.4260	0.3854
	0.4147	0.3814		0.4373	0.3893
	0.4260	0.3854		0.4468	0.4077
	0.4345	0.4033		0.4345	0.4033
R rank (5000 K)					
RW	0.3376	0.3616	RY	0.3463	0.3687
	0.3463	0.3687		0.3551	0.3760
	0.3451	0.3554		0.3533	0.3620
	0.3371	0.3490		0.3451	0.3554
RX	0.3371	0.3490	RZ	0.3451	0.3554
	0.3451	0.3554		0.3533	0.3620
	0.3440	0.3428		0.3515	0.3487
	0.3366	0.3369		0.3440	0.3428

Region	CIE x	CIE y	Region	CIE x	CIE y
T rank (4000 K)					
TW	0.3736	0.3874	TY	0.3871	0.3959
	0.3871	0.3959		0.4006	0.4044
	0.3828	0.3803		0.3952	0.388
	0.3703	0.3726		0.3828	0.3803
TX	0.3703	0.3726	TZ	0.3828	0.3803
	0.3828	0.3803		0.3952	0.388
	0.3784	0.3647		0.3898	0.3716
	0.367	0.3578		0.3784	0.3647
Q rank (5700 K)					
QW	0.3207	0.3462	QY	0.3290	0.3538
	0.3290	0.3538		0.3376	0.3616
	0.3290	0.3417		0.3371	0.3490
	0.3215	0.3350		0.3290	0.3417
QX	0.3215	0.3350	QZ	0.3290	0.3417
	0.3290	0.3417		0.3371	0.3490
	0.3290	0.3300		0.3366	0.3369
	0.3222	0.3243		0.3290	0.3300

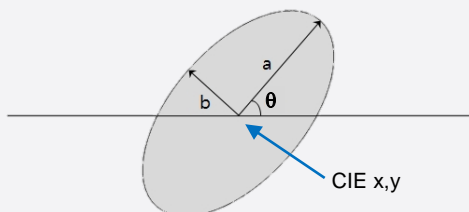
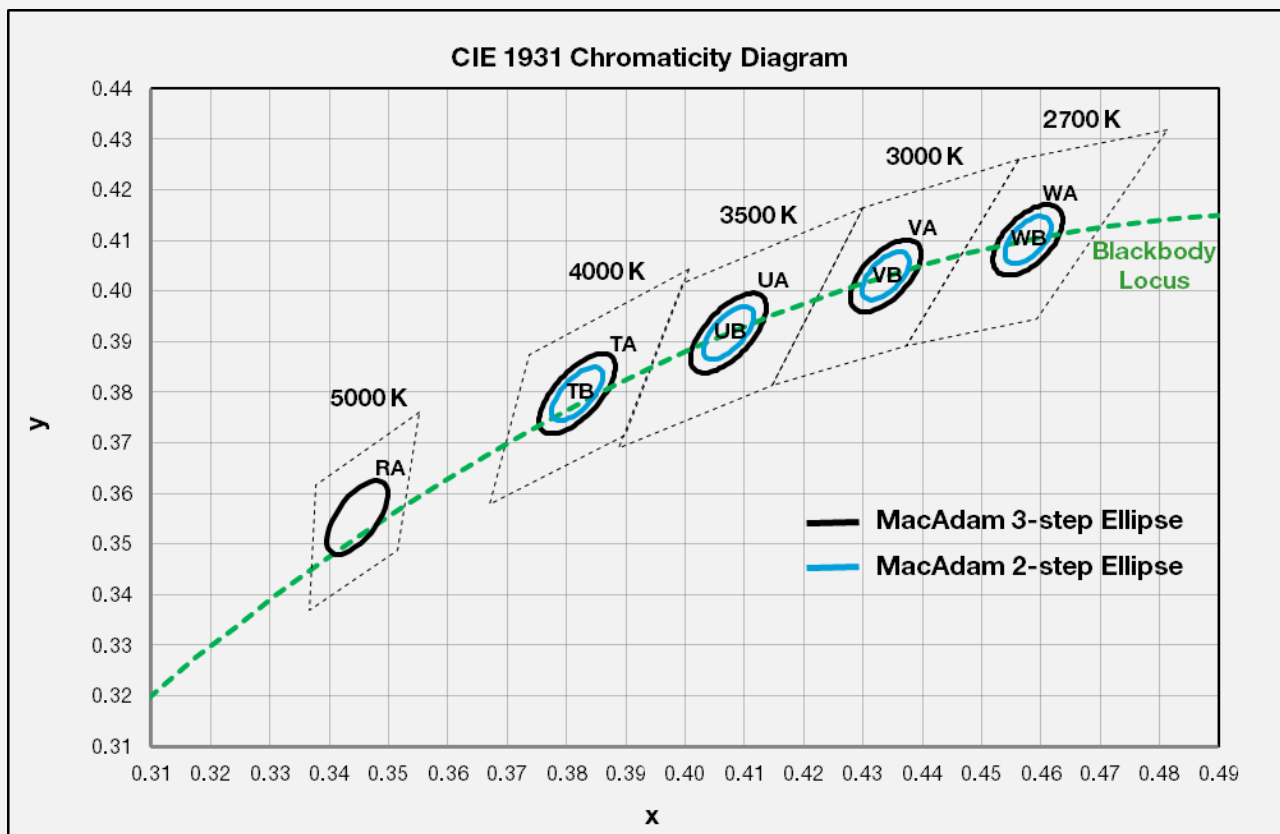
b) Chromaticity Region & Coordinates ($I_F = 540 \text{ mA}$, $T_c = 25 \text{ }^\circ\text{C}$)

MacAdam Ellipse (WA, WB)					
Step	CIE x	CIE y	θ	a	b
2-step	0.4578	0.4101	53.70	0.0054	0.0028
3-step	0.4578	0.4101	53.70	0.0081	0.0042

MacAdam Ellipse (VA, VB)					
Step	CIE x	CIE y	θ	a	b
2-step	0.4338	0.403	53.22	0.0056	0.0027
3-step	0.4338	0.4030	53.22	0.0083	0.0041

MacAdam Ellipse (UA, UB)					
Step	CIE x	CIE y	θ	a	b
2-step	0.4073	0.3917	54.00	0.0062	0.0028
3-step	0.4073	0.3917	54.00	0.0093	0.0041

MacAdam Ellipse (TA, TB)					
Step	CIE x	CIE y	θ	a	b
2-step	0.3818	0.3797	53.72	0.0063	0.0027
3-step	0.3818	0.3797	53.72	0.0094	0.0040

MacAdam Ellipse (RA)					
Step	CIE x	CIE y	θ	a	b
3-step	0.3447	0.3553	59.62	0.0082	0.0035

Note:

Samsung maintains measurement tolerance of: $C_x, C_y = \pm 0.005$

3. Typical Characteristics Graphs

a) Spectrum Distribution ($I_f = 540 \text{ mA}$, $T_c = 25 \text{ }^\circ\text{C}$)

CCT: 2700 K (80 CRI)

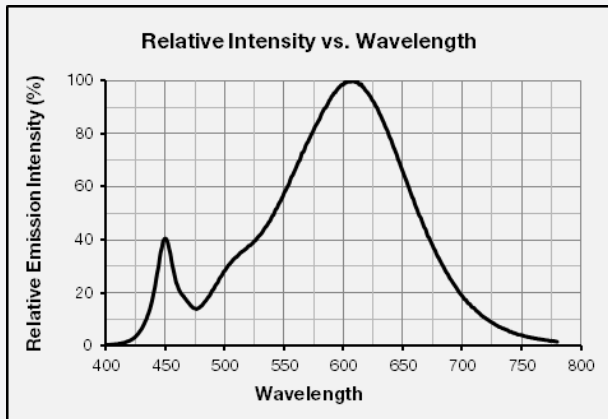

CCT: 3000 K (80 CRI)

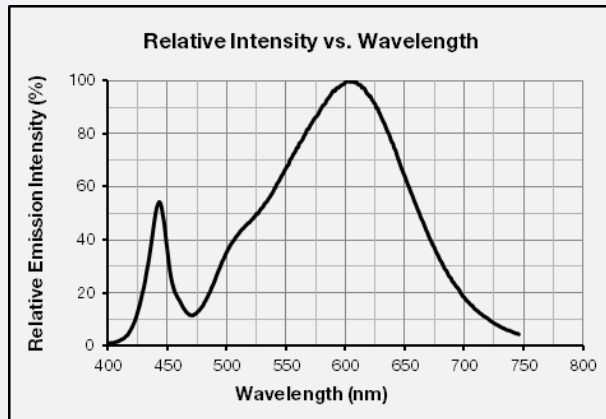

CCT: 3500 K (80 CRI)

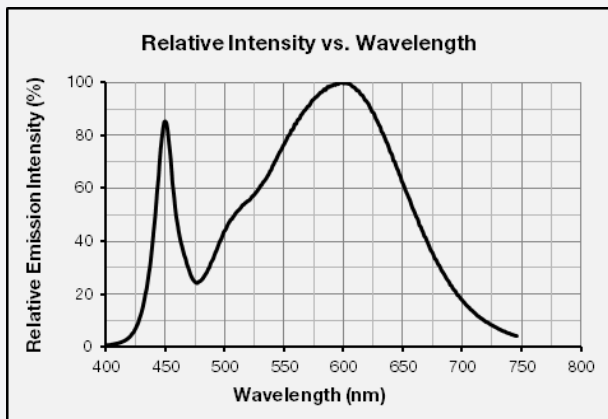

CCT: 4000 K (80 CRI)

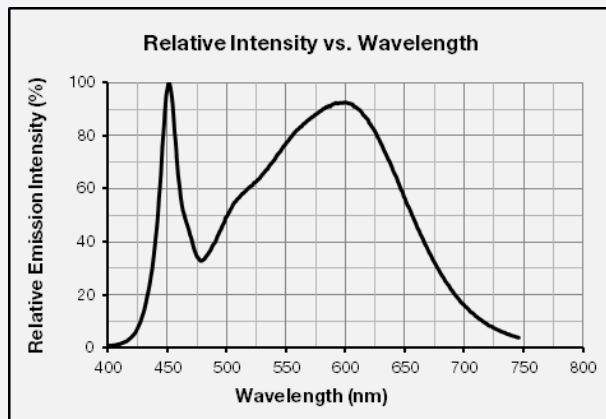

CCT: 5000 K (80 CRI)

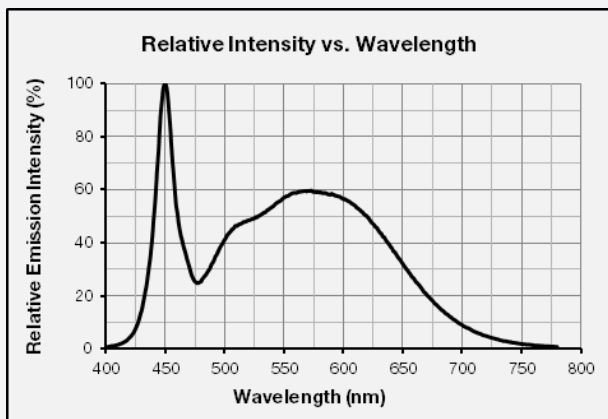

CCT: 5700 K (80 CRI)

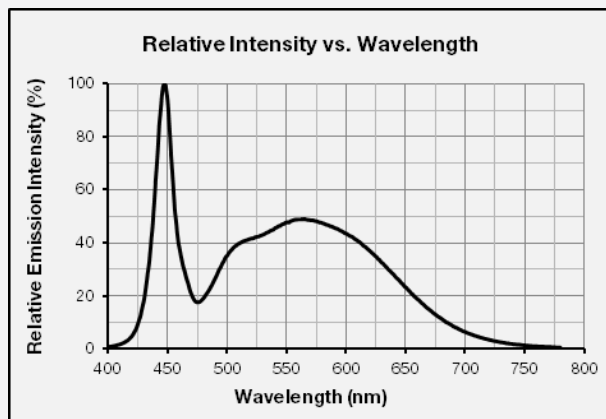

CCT: 2700 K (90 CRI)

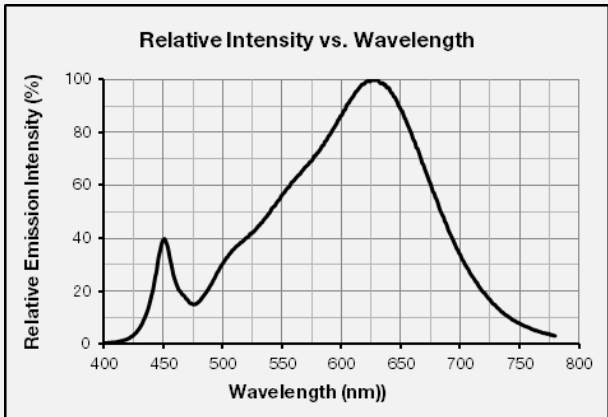

CCT: 3000 K (90 CRI)

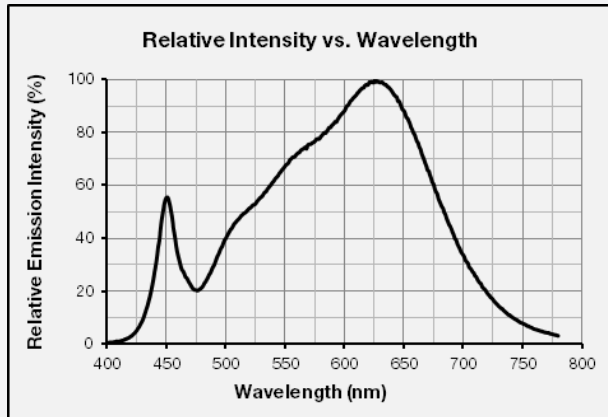

CCT: 3500 K (90 CRI)

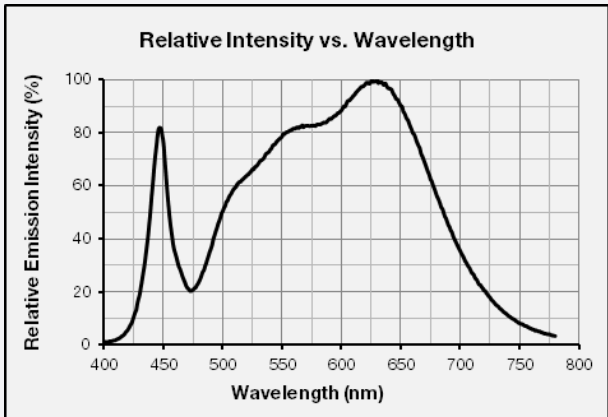

CCT: 4000 K (90 CRI)

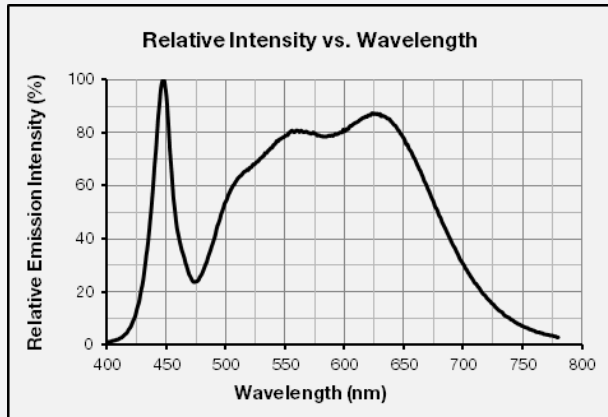

b) Forward Current Characteristics (T_c = 25 °C)

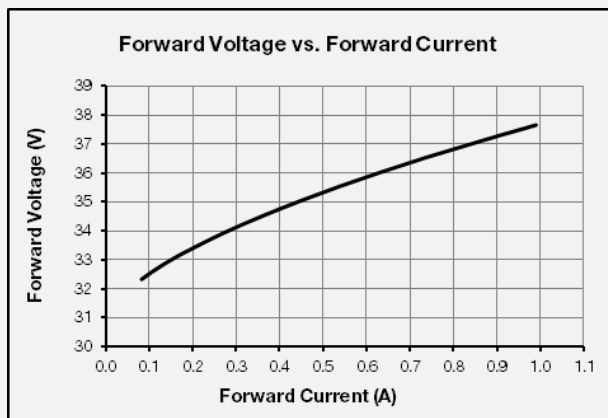
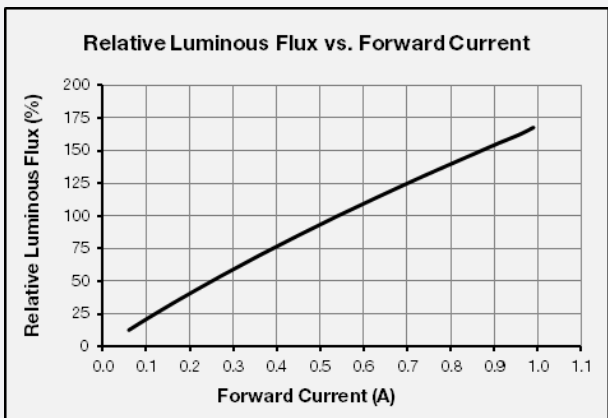

c) Temperature Characteristics ($I_F = 540 \text{ mA}$)

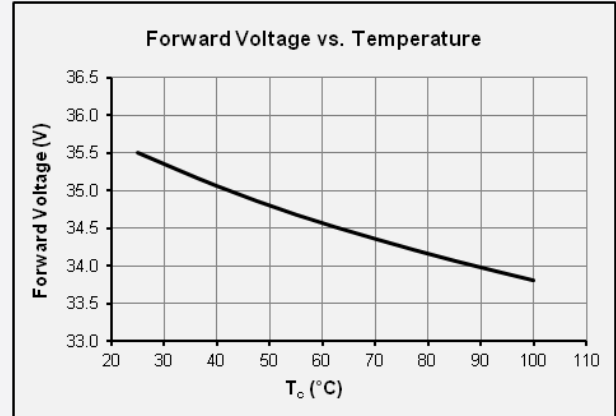
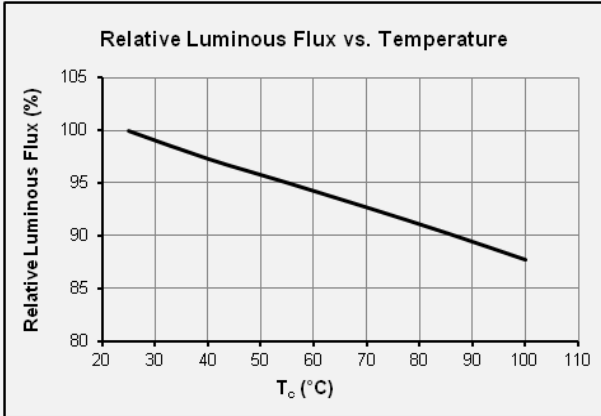

d) Color Shift Characteristics

$T_c = 25^\circ\text{C}$

$I_F = 540 \text{ mA}$

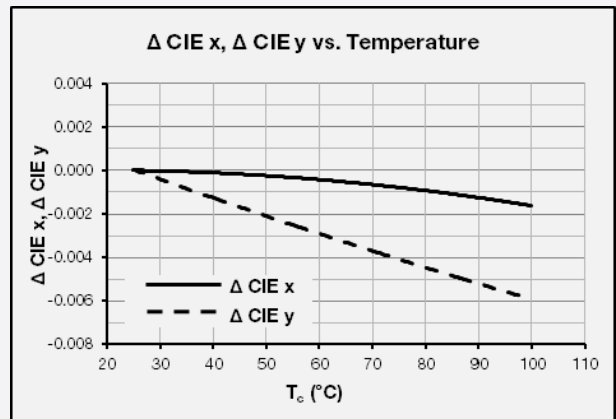
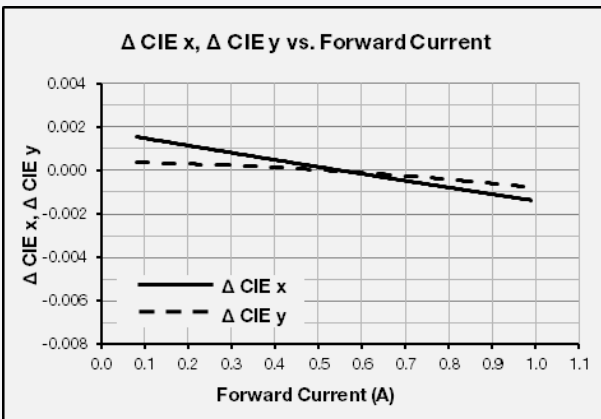

e) Derating Curve

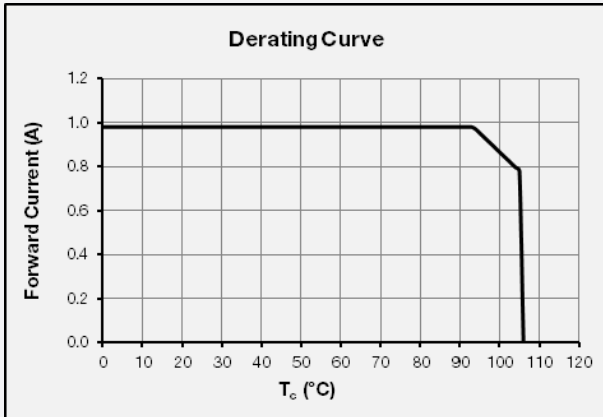
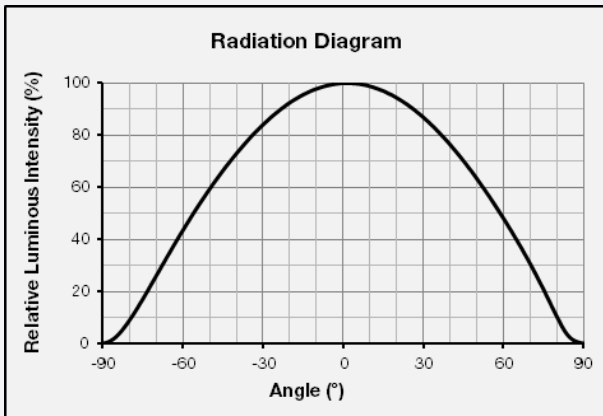
f) Beam Angle Characteristics ($I_F = 540 \text{ mA}$, $T_c = 25^{\circ}\text{C}$)

4. Outline Drawing & Dimension

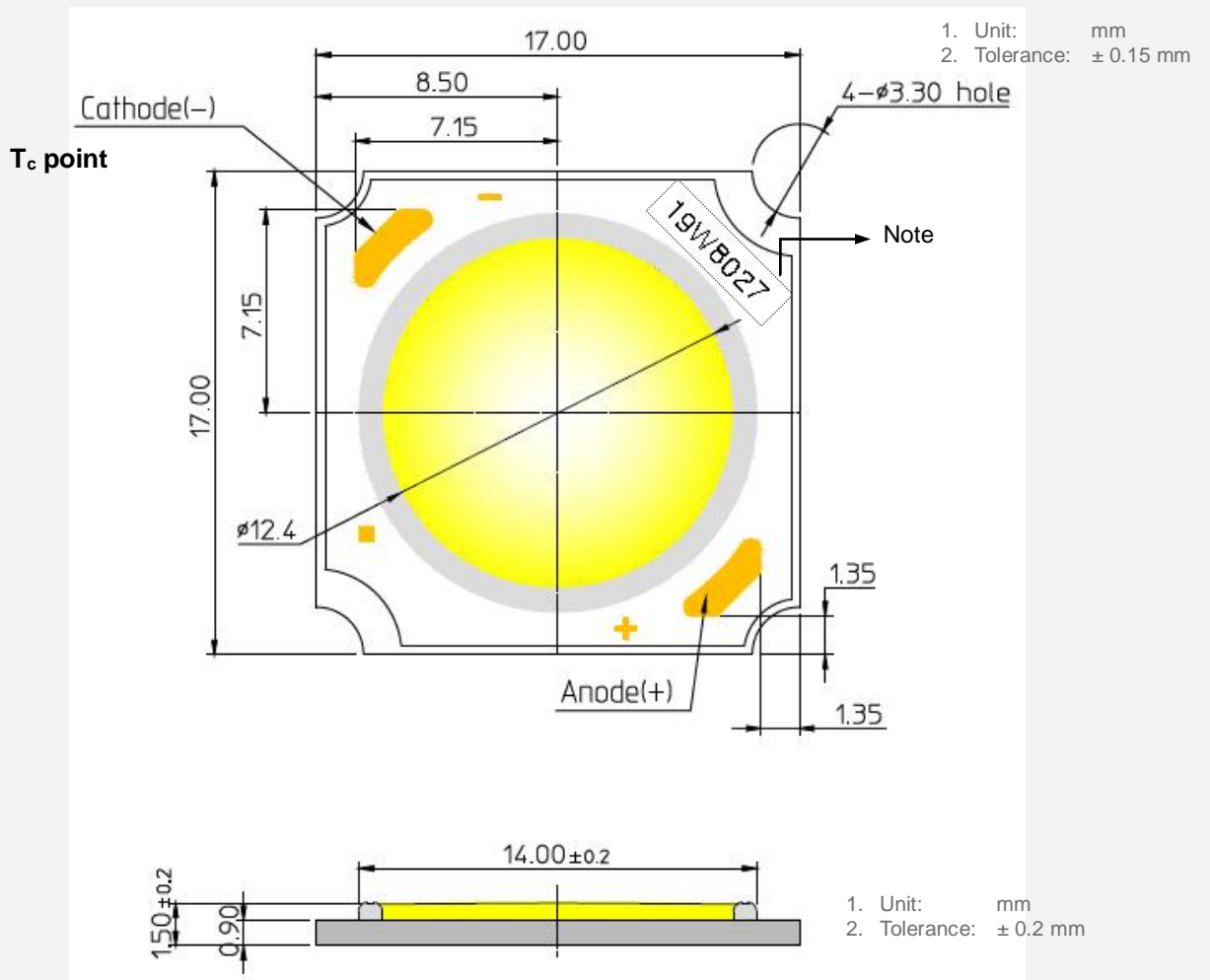

Item	Dimension	Tolerance	Unit
Length	17.0	± 0.15	mm
Width	17.0	± 0.15	mm
Height	1.50	± 0.20	mm
Light Emitting Surface (LES) Diameter	12.4	± 0.15	mm

Note: Denoted product information above is only an example
(19W8027 : 19W, CRI80+, 2700K)

5. Reliability Test Items & Conditions

a) Test Items

Test Item	Test Condition	Test Hour / Cycle
Room Temperature Life Test	25 °C, I _F = max	1000 h
High Temperature Humidity Life Test	85 °C, 85 % RH, DC Derating, I _F = max	1000 h
High Temperature Life Test	105 °C, DC Derating, I _F = max	1000 h
Low Temperature Life Test	-40 °C, DC 980 mA	1000 h
High Temperature Storage	120 °C	1000 h
Low Temperature Storage	-40 °C	1000 h
Thermal Shock	-45 °C / 15 min ↔ 125 °C / 15 min temperature change in 5 min	200 cycles
Temperature Cycle On/Off Test	-40 °C / 85 °C each 20 min, 100 min transfer power on/off each 5 min, DC 540 mA	100 cycles
Temperature Humidity Storage Test	-10 °C ↔ 25 °C, 95 % RH ↔ 85 °C, 95 % RH (24 h / cycle)	100 cycles
ESD (HBM)	R ₁ : 10 MΩ R ₂ : 1.5 kΩ C: 100 pF V: ±2 kV	5 times
ESD (MM)	R ₁ : 10 MΩ R ₂ : 0 kΩ C: 200 pF V: ±0.5 kV	5 times
Vibration Test	20 ~ 80 Hz (displacement: 0.06 inch, max. 20 g) 80 ~ 2 kHz (max. 20 g) min. frequency ↔ max. frequency 4 min transfer	4 times
Mechanical Shock Test	1500 g, 0.5 ms each of the 6 surfaces (3 axis x 2 sides)	5 times
Salt Spray Test	35 °C, 5 % salt water 8 h spray, 16 h dwell	2 cycles

b) Criteria for Judging the Damage

Item	Symbol	Test Condition (T _c = 25 °C)	Limit	
			Min.	Max.
Forward Voltage	V _F	I _F = 540 mA	L.S.L. * 0.9	U.S.L. * 1.1
Luminous Flux	Φ _v	I _F = 540 mA	L.S.L. * 0.7	U.S.L. * 1.3

6. Label Structure

a) Label Structure

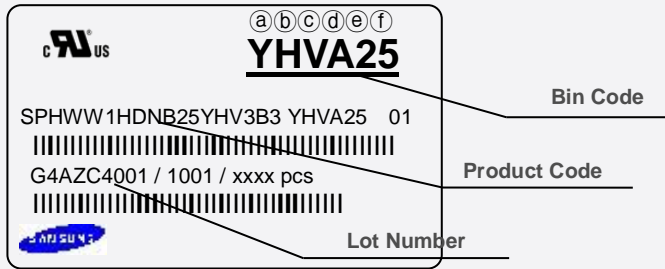

Note: Denoted bin code and product code above is only an example (see description on page 5)

Bin Code:

- ⒶⒷ: Forward Voltage bin (refer to page 11)
- ⒸⒹ: Chromaticity bin (refer to page 9-10)
- ⒺⒻ: Luminous Flux bin (refer to page 6)

b) Lot Number

The lot number is composed of the following characters:

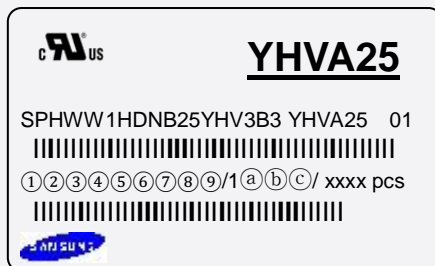

① ③④⑤⑥⑦⑧⑨ / 1ⒶⒷⒸ / xxxx pcs

- ① : Production site (S: Giheung, Korea, G: Tianjin, China)
- ② : 4 (LED)
- ③ : Product state (A: Normal, B: Bulk, C: First Production, R: Reproduction, S: Sample)
- ④ : Year (Z: 2015, A: 2016, B: 2017...)
- ⑤ : Month (1~9, A, B, C)
- ⑥⑦⑧⑨ : Day (1~9, A, B~V)
- ⒶⒷⒸ : Product serial number (001 ~ 999)

7. Packing Structure

Packing material	Max. quantity in pcs of COB	Dimension (mm)			
		Length	Width	Height	Tolerance
Tray	40	260	190	11.5	1.0
Anti-static Bag	200 (6 trays)	387	350	-	10.0
Box	1,400 (7 anti-static bag)	-	-	-	-

a) Packing Structure

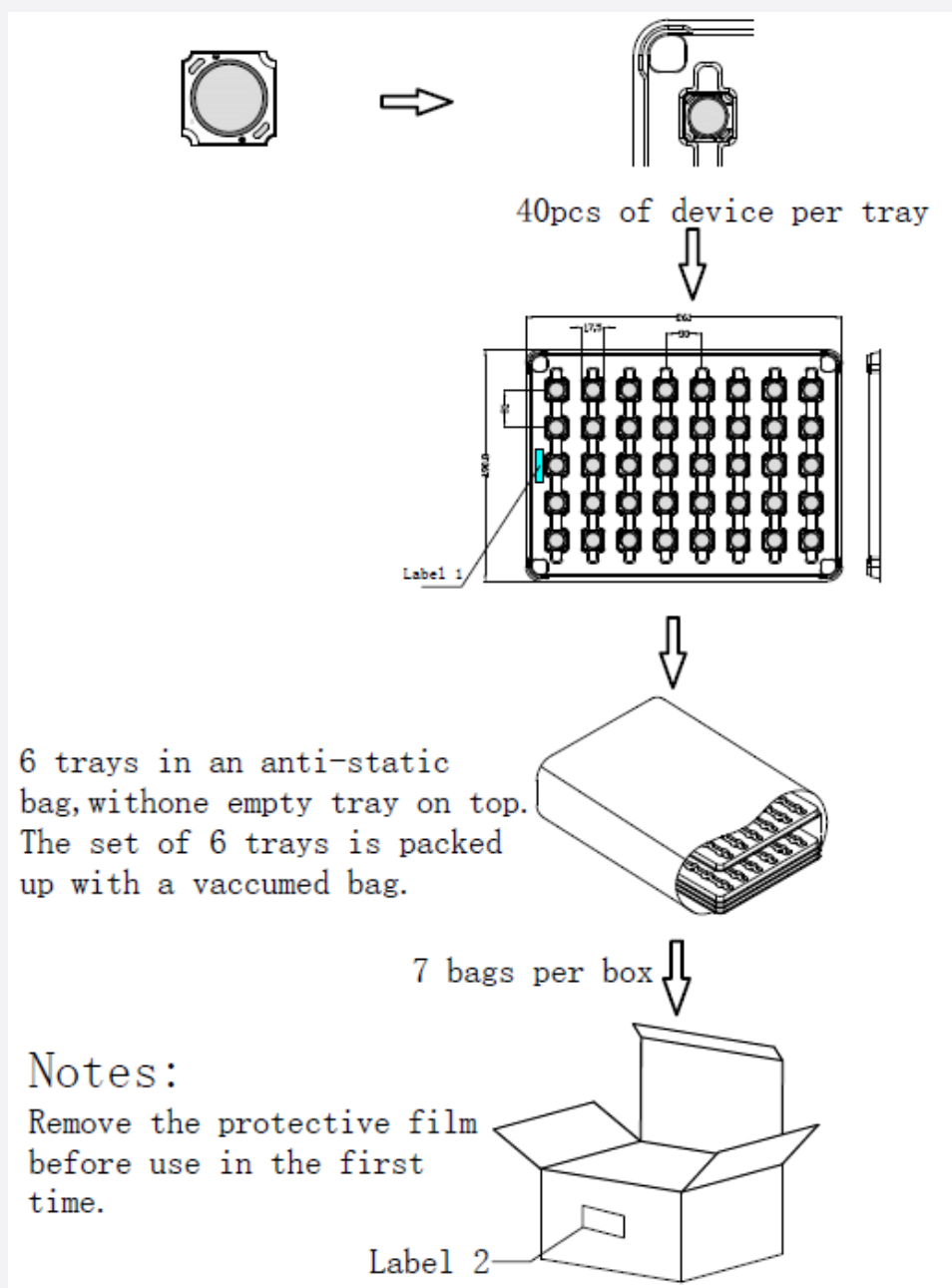

b) Tray

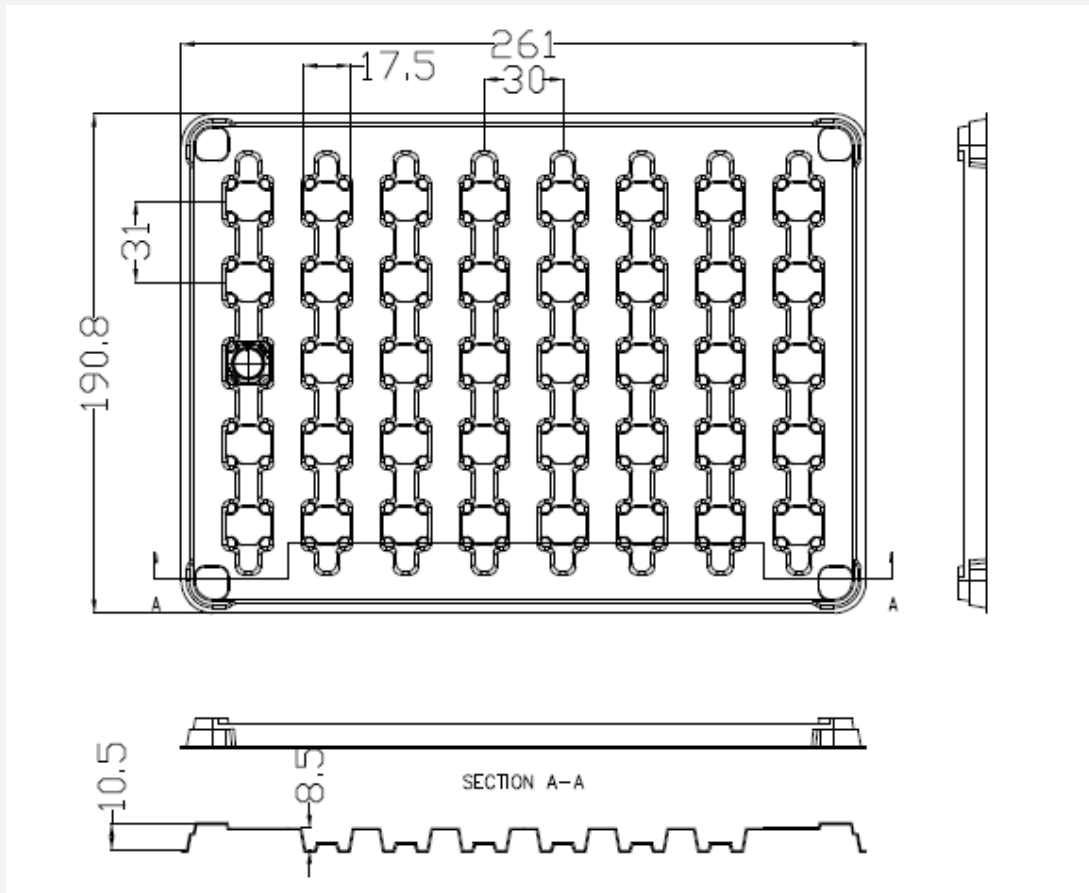

c) Anti-static Bag

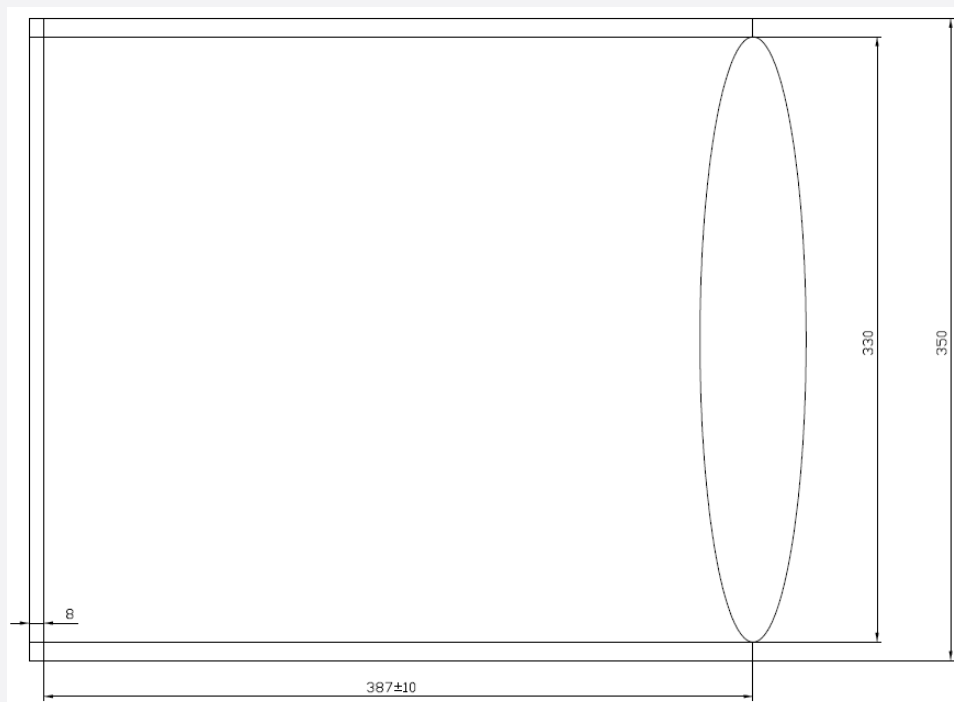

8. Precautions in Handling & Use

- 1) This device should not be used in any type of fluid such as water, oil, organic solvent, etc. When cleaning is required, IPA is recommended as the cleaning agent. Some solvent-based cleaning agent may damage the silicone resins used in the device.
- 2) LEDs must be stored in a clean environment. If the LEDs are to be stored for three months or more after being shipped from Samsung, they should be packed with a nitrogen-filled container (shelf life of sealed bags is 12 months at temperature 0~40 °C, 0~90 % RH).
- 3) After storage bag is opened, device subjected to soldering, solder reflow, or other high temperature processes must be:
 - a. Mounted within 672 hours (28 days) at an assembly line with a condition of no more than 30 °C / 60 % RH, or
 - b. Stored at <10 % RH
- 4) Repack unused products with anti-moisture packing, fold to close any opening and then store in a dry place.
- 5) Devices require baking before mounting, if humidity card reading is >60 % at 23 ± 5 °C.
- 6) Devices must be baked for 1 hour at 60 ± 5 °C, if baking is required.
- 7) The LEDs are sensitive to the static electricity and surge current. It is recommended to use a wrist band or anti-electrostatic glove when handling the LEDs. If voltage exceeding the absolute maximum rating is applied to LEDs, it may cause damage or even destruction to LED devices. Damaged LEDs may show some unusual characteristics such as increase in leakage current, lowered turn-on voltage, or abnormal lighting of LEDs at low current.
- 8) In case of driving the LC019B around the extremely low current level, chips might exhibit different brightness due to the variation in I-V characteristics of each one. This is normal and does not adversely affect the performance of product.
- 9) VOCs (Volatile Organic Compounds) can be generated from adhesives, flux, hardener or organic additives used in luminaires (fixtures). Transparent LED silicone encapsulant is permeable to those chemicals and they may lead to a discoloration of encapsulant when they exposed to heat or light. This phenomenon can cause a significant loss of light emitted (output) from the luminaires. In order to prevent these problems, we recommend users to know the physical properties of materials used in luminaires and they must be carefully selected.
- 10) The resin area is very sensitive, please do not handle, press, touch, rub, clean, or pick by with tweezers on it. Instead, please pick at the handling area as indicated below.

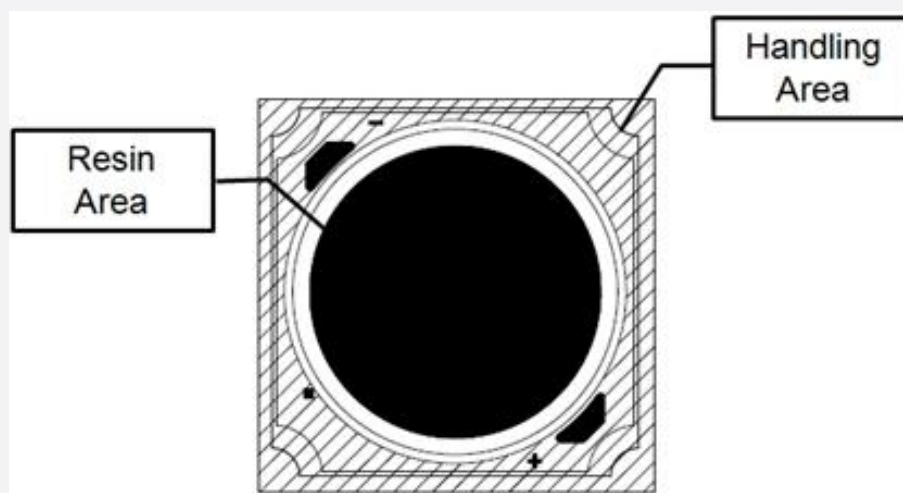

Legal and additional information.

[About Samsung Electronics Co., Ltd.](#)

Samsung Electronics Co., Ltd. inspires the world and shapes the future with transformative ideas and technologies, redefining the worlds of TVs, smartphones, wearable devices, tablets, cameras, digital appliances, printers, medical equipment, network systems and semiconductors.

We are also leading in the Internet of Things space through, among others, our Digital Health and Smart Home initiatives. We employ 307,000 people across 84 countries. To discover more, please visit our official website at www.samsung.com and our official blog at global.samsungtomorrow.com.

Copyright © 2015 Samsung Electronics Co., Ltd. All rights reserved.

Samsung is a registered trademark of Samsung Electronics Co., Ltd.

Specifications and designs are subject to change without notice. Non-metric weights and measurements are approximate. All data were deemed correct at time of creation. Samsung is not liable for errors or omissions. All brand, product, service names and logos are trademarks and/or registered trademarks of their respective owners and are hereby recognized and acknowledged.

Samsung Electronics Co., Ltd.

95, Samsung 2-ro

Giheung-gu

Yongin-si, Gyeonggi-do, 446-711

KOREA

www.samsungled.com

