

THIS COPY IS PROVIDED ON A RESTRICTED BASIS AND IS NOT TO BE USED IN ANY WAY DETRIMENTAL TO THE INTERESTS OF PANDUIT CORP.

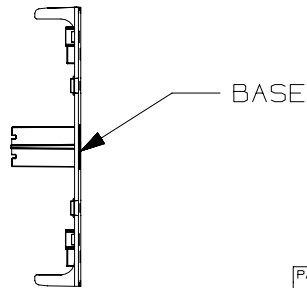
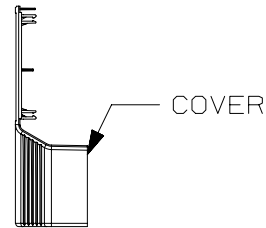
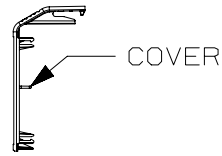
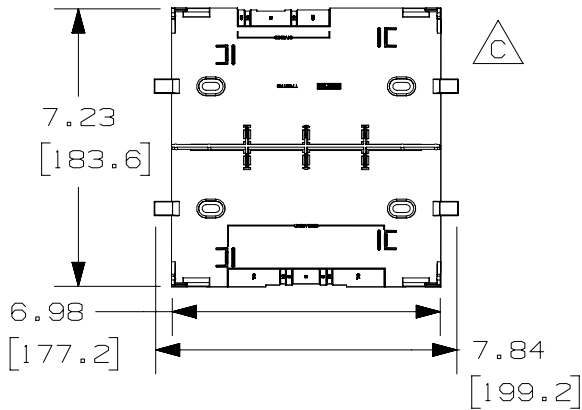
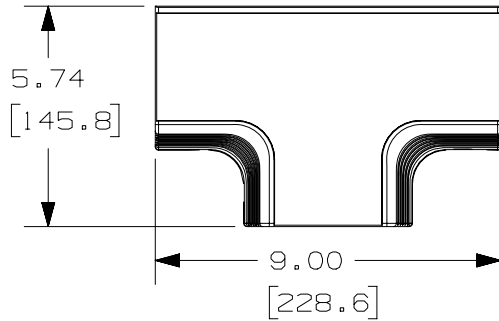
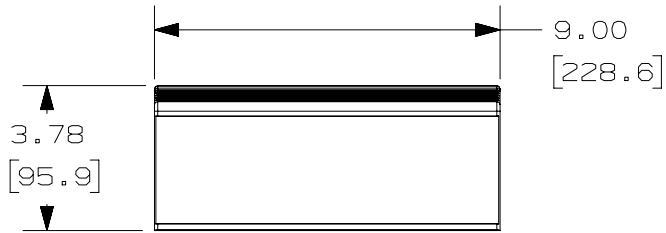

PANDUIT P/N	WEIGHT
T702TR	8.6 LB/10 PCS (3.9 kg/10 PCS)

NOTES:

- SEE CURRENT CATALOG FOR ADDITIONAL PART SUFFIXES TO INDICATE COLOR AND OR PACKAGE QUANTITY.
- THIS PRODUCT IS FEATURED WITH THE TIA/EIA COMPLIANT BEND RADIUS.
- BREAKOUTS FOR LD3, LD5, LD10, T45 AND T-70 RACEWAYS.
- COVER IS EXTENDED OUT AND DOWN AROUND SIDES OF BASE WHEN ASSEMBLED.
- USE INSERT T702TRI, FOR DIVIDED TRANSITIONS.
- DIMENSIONS IN PARENTHESSES ARE IN METRIC.

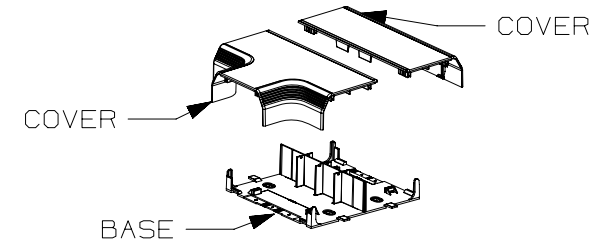

PART NUMBER: T702TR	PRODUCT SPECIFICATION NUMBER: N/A
FMEA/CONTROL PLAN NUMBER: N/A	PACKAGING INSTRUCTION NUMBER: N/A
INSPECTION INSTRUCTION NUMBER: N/A	WORK INSTRUCTION NUMBER: N/A

TITLE	
TWIN-70 TRANSITION	
CUSTOMER DRAWING	
ITEM REVISION NAME D34866EC/03	PANDUIT
DATASET FILE NAME D34866EC_DC_T702TR/03	
UNLESS OTHERWISE SPECIFIED, DIMENSIONAL TOLERANCES ARE: IN [mm] .x ± .1 [.254] .xxx ± .005 [.127] .xx ± .01 [.25] ANGLES ± 5 °	MATERIAL: PVC A
 THIRD ANGLE PROJECTION	DRAWING NUMBER: 34866-91 E
DRAWN BY DW	DATE 04-07-98
CHK HIW	SCALE NONE
SHT 1 OF 1	
SIZE A	

REV	DATE	BY	CHK	APR	DESCRIPTION	ECN
3	7-12-16	BJN	WFMI	SRI	D. UPDATED METRIC WEIGHT TO 3.9 kg/10 PCS, WAS 3.8 g/10 PCS E. UPDATED TITLE BLOCK	34866-91
2	01-13-00	JHNU	BKR	HIW	C. REVISED GEOMETRY FOR T45 BREAKOUT B. ADDED T45 TO NOTE 3	34866-91
1	07-29-99	DW	HIW	HIW	A. REVISED MATERIAL AND WEIGHT	34866-91
R	04-07-98	DW	HIW	HIW	RELEASED TO PRODUCTION	34866-91

D10100DA/14