

FRONT VIEW WITH COVER REMOVED AND BACK PANEL SHOWN

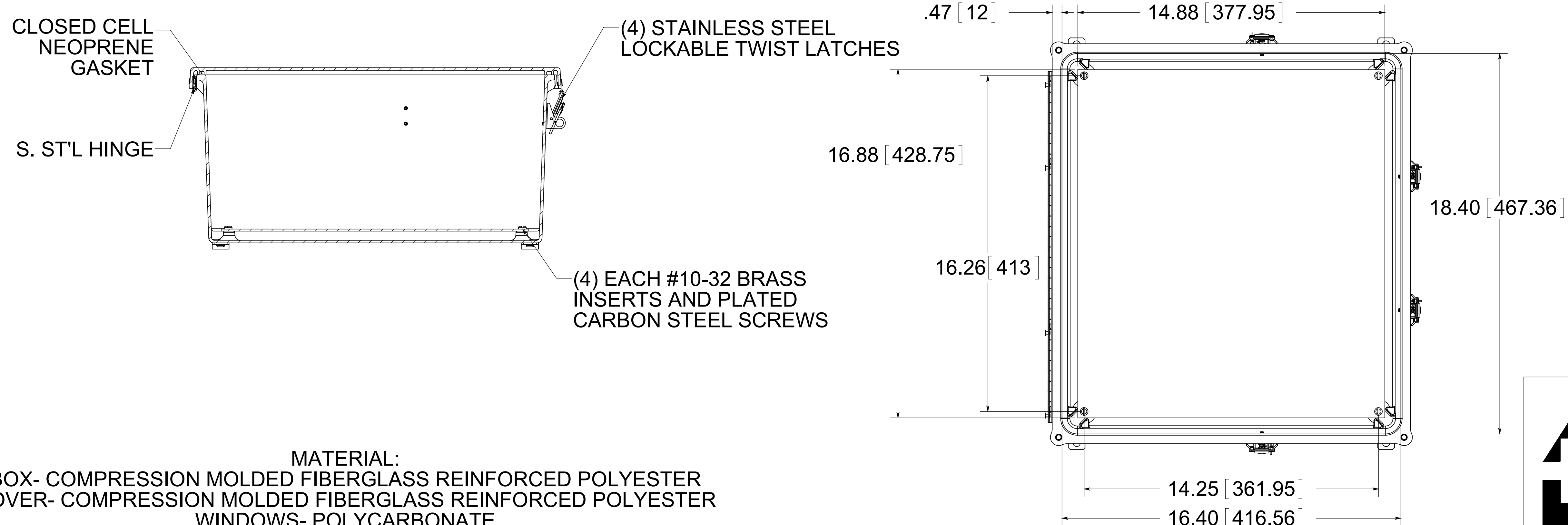

MATERIAL:
 BOX- COMPRESSION MOLDED FIBERGLASS REINFORCED POLYESTER
 COVER- COMPRESSION MOLDED FIBERGLASS REINFORCED POLYESTER
 WINDOWS- POLYCARBONATE

PART No. PJ18168T
 for more information visit
www.hammfg.com
 Data subject to change without notice
 Drawing Not to Scale