

PHOTONIC DETECTORS INC.

Silicon Photodiode, Filter Combination Photovoltaic (center wavelength 680 nm) Type PDR-V468-46

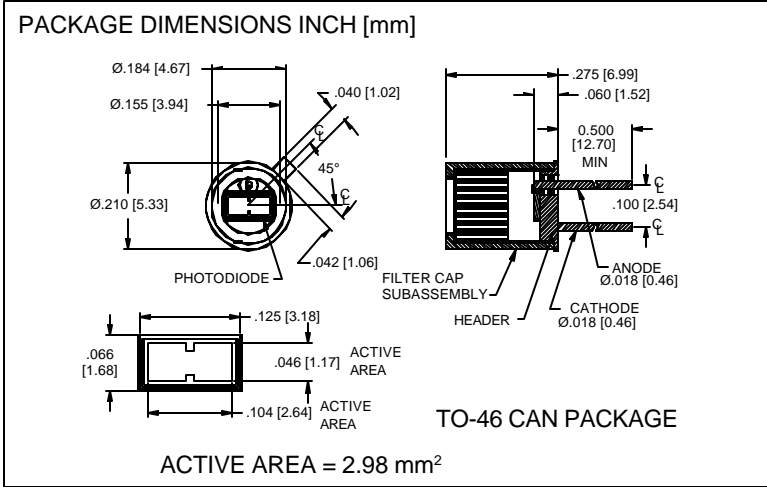

FEATURES

- 680 nm CWL
- 10 nm FWHM
- Large active area

DESCRIPTION

The **PDR-V468-46** is a silicon, PIN planar diffused, photodiode with a narrow band interference filter. The detector filter combination has a narrow 10 nm half bandwidth designed for low noise photovoltaic applications. Packaged in a TO-46 metal can.

APPLICATIONS

- Spectrophotometry
- Chemistry instrumentation
- Liquid chromatography

ABSOLUTE MAXIMUM RATING (TA=25°C unless otherwise noted)

SYMBOL	PARAMETER	MIN	MAX	UNITS
V _{BR}	Reverse Voltage		75	V
T _{STG}	Storage Temperature	-20	+85	°C
T _O	Operating Temperature Range	-15	+70	°C
T _S	Soldering Temperature*		+240	°C
I _L	Light Current		0.5	mA

*1/16 inch from case for 3 secs max

SPECTRAL RESPONSE

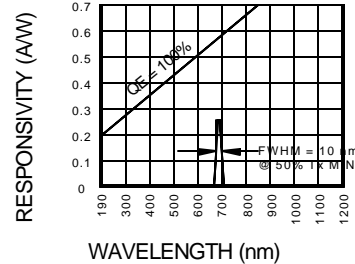

ELECTRO-OPTICAL CHARACTERISTICS (TA=25°C unless otherwise noted)

SYMBOL	CHARACTERISTIC	TEST CONDITIONS	MIN	TYP	MAX	UNITS
I _{SC}	Short Circuit Current***	H = 100 fc, 2850 K	35	40		μA
I _D	Dark Current	H = 0, V _R = 10 V		150	300	pA
R _{SH}	Shunt Resistance	H = 0, V _R = 10 mV	1.0	6		GΩ
TC R _{SH}	R _{SH} Temp. Coefficient	H = 0, V _R = 10 mV		-8		% / °C
C _J	Junction Capacitance	H = 0, V _R = 0 V**		340		pF
CWL	Center Wavelength	(CWL, λ ₀) +/- 2 nm		680		nm
HBW	Half Bandwidth	(FWHM)		10		nm
V _{BR}	Breakdown Voltage	I = 10 μA	30	50		V
NEP	Noise Equivalent Power	V _R = 10 mV @ Peak		5x10 ⁻¹⁴		W/√Hz
tr	Response Time	RL = 1 KΩ V _R = 0 V		450		nS

Information in this technical data sheet is believed to be correct and reliable. However, no responsibility is assumed for possible inaccuracies or omission. Specifications are subject to change without notice.**f = 1 MHz, ***without filter

[FORM NO. 100-PDR-V468-46 REV N/C]