

3.0 mm×2.6 mm 2 terminals SMD Light Touch Switches

Type: **EVPBA**

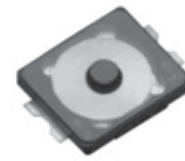

■ Features

- External dimensions: 3.0 mm×2.6 mm, Height 0.58 mm
- High operability
Equipped with an actuator (push plate)

■ Recommended Applications

- Operation switches for portable electronic equipment
(Mobile phone, Portable audio)

■ Explanation of Part Numbers

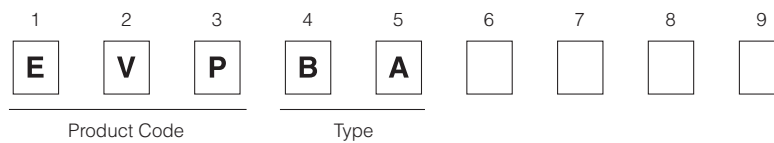

■ Specifications

Type		Snap action/Push-on type SPST
Electrical	Rating	10 μA 2 V DC to 20 mA 15 V DC (Resistive load)
	Contact Resistance	500 mΩ max.
	Insulation Resistance	50 MΩ min. (at 100 V DC)
	Dielectric Withstanding Voltage	250 V AC for 1 minute
	Bouncing	10 ms max. (ON, OFF)
Mechanical	Operating Force	1.8 N
	Travel	0.13 mm
Endurance	Operating Life	300,000 cycles min.
Operating Temperature		-40 °C to +85 °C
Storage Temperature		-40 °C to +85 °C (Bulk) -20 °C to +60 °C (Taping)
Minimum Quantity/Packing Unit		20,000 pcs. Embossed Taping (Reel Pack)
Quantity/Carton		100,000 pcs.

Note: Non washable

Design and specifications are each subject to change without notice. Ask factory for the current technical specifications before purchase and/or use.
Should a safety concern arise regarding this product, please be sure to contact us immediately.

■ Dimensions in mm (not to scale)

EVPBA

(Embossed Taping)

General dimension tolerance : ± 0.1
 () dimensions are reference dimensions.

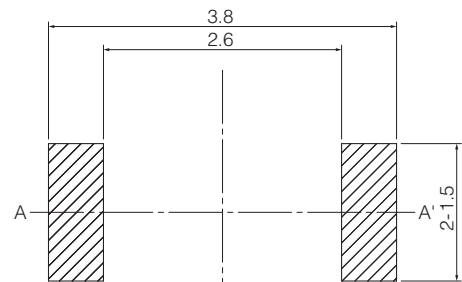
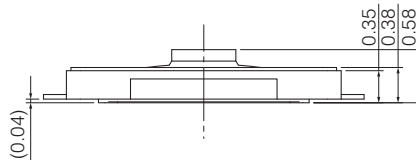
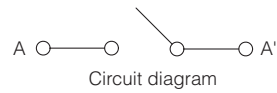
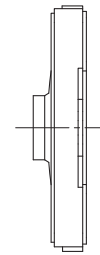
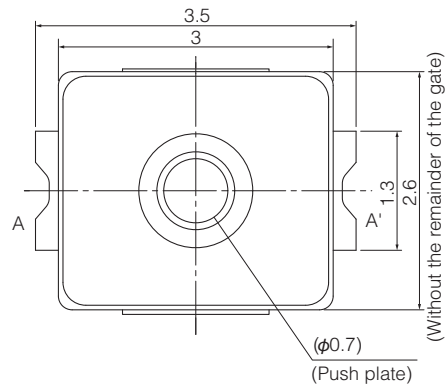
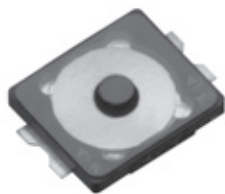

Land pattern plan

Soldering thickness $t=0.08\pm 0.01$

- * The opening ratio of the solder stencil to a land pattern shall be 70%
- * If you design different stencil mask and land pattern, or apply different soldering thickness compared with our recommended pattern as described above, please ask us in advance.

Part Numbers	Operating Force	Height	Operating Life
EVPBABA3A	1.8 N	0.58 mm	300,000 cycles

Design and specifications are each subject to change without notice. Ask factory for the current technical specifications before purchase and/or use.
 Should a safety concern arise regarding this product, please be sure to contact us immediately.

■ Recommended Reflow Soldering Conditions

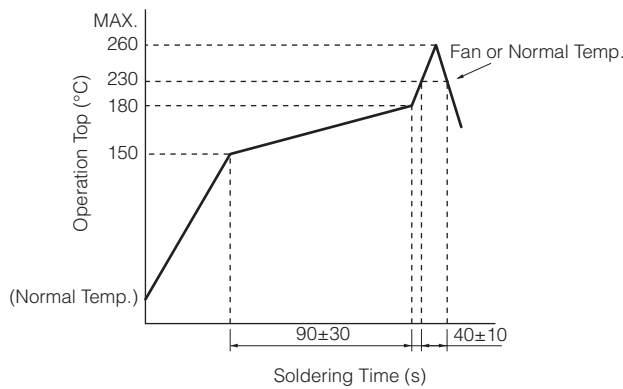

* Reflow temperature may vary by location even in the same reflow condition. Please check the reflow temperature at terminals and at the top of a switch to make sure the both temperatures are within the specification. If even one of them is out of the specifications, please adjust.

● Embossed Carrier Taping

Tape width=12.0 mm (A=12.0 mm)

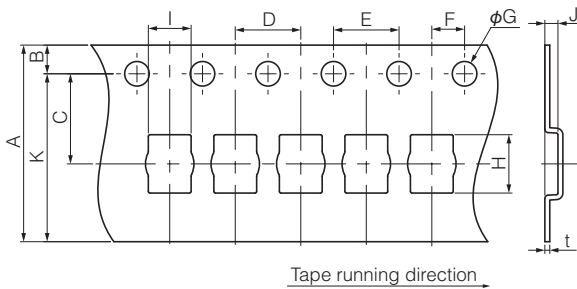

Taping condition : Lack of products in the middle of taping should be one MAX, but total quantity specified in the specifications should be secured.
 Peeling off strength of top tape : It should be within 0.2N to 1.0N at 165 degree in peeling off angle.
 Joint of carrier tape : One joint per one reel may exist.

Part No.	Height	A	B	C	D	E	F	G	H	I	J	K	t
EVPBA	0.58	12.0±0.3	1.75±0.10	5.5±0.1	4.0±0.1	4.0±0.1	2.0±0.1	1.5±0.3	3.75±0.20	2.85±0.20	0.8±0.2	(10.25)	0.3 ^{+0.15} / _{-0.1}

Unit: mm