



PART No. EN4SD20168WLG

for more information visit
www.hammfg.com

Data subject to change without notice

Isometric drawing Not to Scale

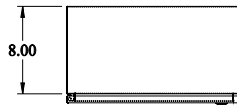
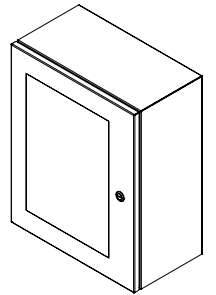

TOP VIEW

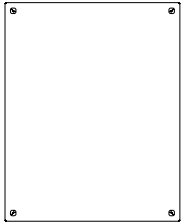

BACK VIEW

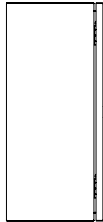

LEFT SIDE VIEW

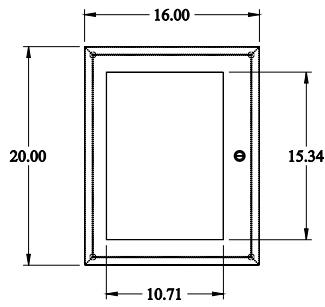

FRONT VIEW

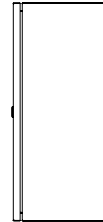

RIGHT SIDE VIEW

ISOMETRIC VIEW

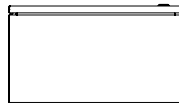

BOTTOM VIEW