

SMT Air Coil Inductor

AIAC-1606C

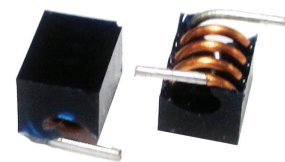

RoHS/RoHS II compliant



4.04 x 3.10 x 1.37mm

FEATURES:

- High current design
- Wide Range Frequency Response
- Excellent Q & SRF
- Standard flat cap suitable for automatic placement.

APPLICATIONS:

- Widely used in Cordless Phones, High Frequency Communication Equipments, Intercom, CATV,RFID
- Suitable for metal sensors and proximity sensors
- Noise suppression for RF power supply/bias
- I/O filtering, frequency selection for audio devices such as Loudspeakers,Hifi
- Impedance Matching for transceivers
- Improves switch isolation for RF circuit

STANDARD SPECIFICATIONS:

PARAMETERS

ABRACON P/N:	AIAC-0805C
Operating temperature:	-40 °C ~ +125 °C
Storage temperature:	-25°C to + 60°C in tape and reel

Part Number AIAC-0606C- Inductance Code	Inductance	Tolerance	DCR (Max)	Q(Min)	SRF(Min)	Rated Current (Max)	No. of Turns
Units	nH	%	mΩ		GHz	A	
Symbol	L	J	DCR			IDC	
AIAC-1606C-06	5.6	G	9.0	100	6.5	1.6	6
AIAC-1606C-07	7.15	G	10.0	100	6.0	1.6	7

Test Conditions and equipments

Test frequency: 800MHz, 0.25Vrms

Equipment: HP4286A RF LCR meter

PART IDENTIFICATION:

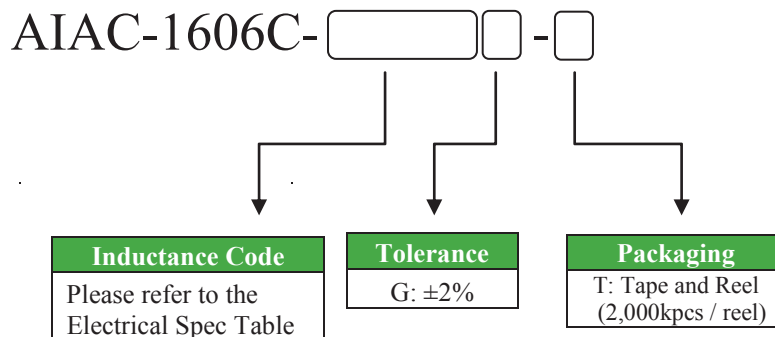

SMT Air Coil Inductor

AIAC-1606C

 RoHS/RoHS II compliant

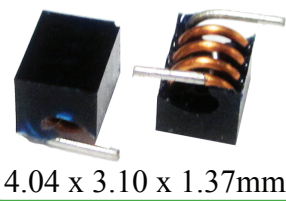

4.04 x 3.10 x 1.37mm

OUTLINE DRAWING:

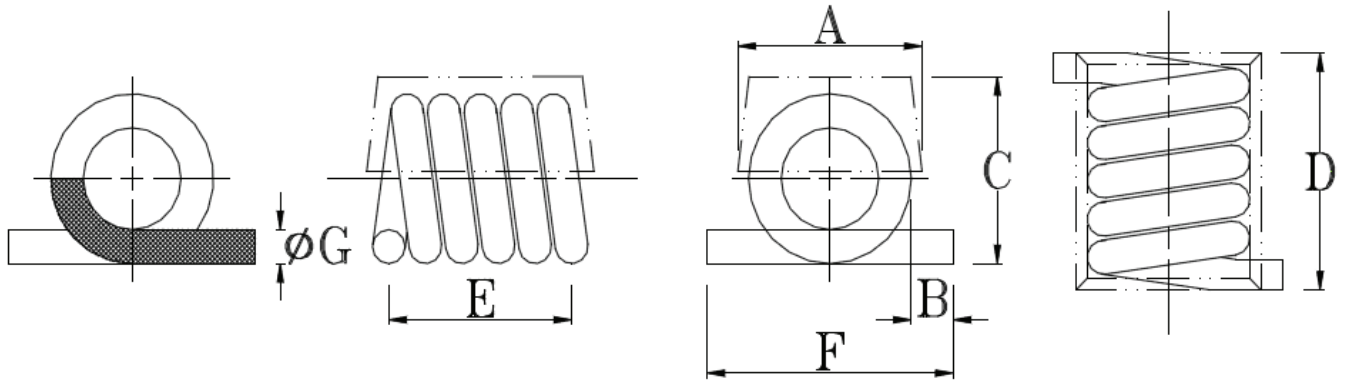

A	B	C	D	E	F
1.42±0.13	0.89±0.25	1.37±0.15	4.04±0.30	3.66±0.30	3.10±0.30

Schematic

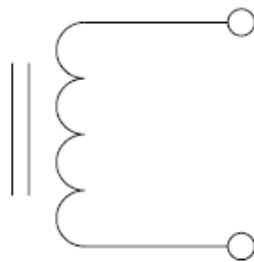

Recommended Land Pattern

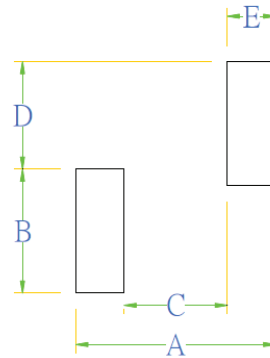

A	B	C	D	E
4.45	2.46	2.87	1.02	0.79

Dimension: mm

SMT Air Coil Inductor

AIAC-1606C



RoHS/RoHS II compliant

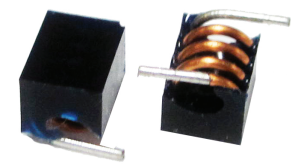

4.04 x 3.10 x 1.37mm

REFLOW PROFILE:

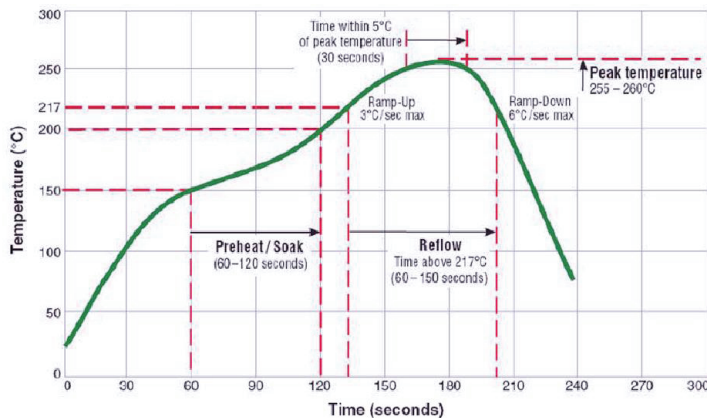

TAPE & REEL:

T: 2,000pcs / reel

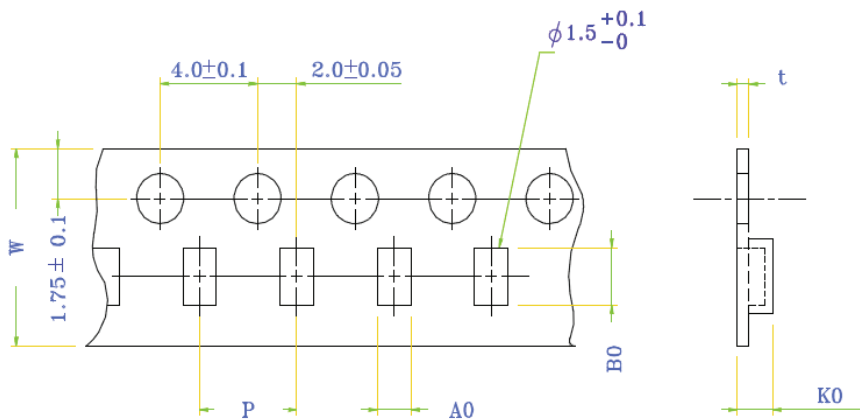

A0	B0	K0	P	W	T
4.0±0.1	4.7±0.1	1.75±0.1	4.0±0.1	12±0.3	0.35±0.05

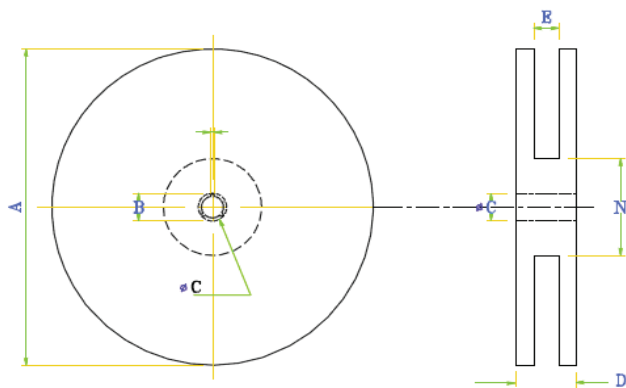

A	B	C	D	E	N
180 max	21±0.8	13±0.5,-0.2	18.4 max	12.4±0.2, -0.0	50 min

Dimension: mm

ATTENTION: Abracon Corporation's products are COTS – Commercial-Off-The-Shelf products; suitable for Commercial, Industrial and, where designated, Automotive Applications. Abracon's products are not specifically designed for Military, Aviation, Aerospace, Life-dependant Medical applications or any application requiring high reliability where component failure could result in loss of life and/or property. For applications requiring high reliability and/or presenting an extreme operating environment, written consent and authorization from Abracon Corporation is required. Please contact Abracon Corporation for more information.

ABRACON IS
ISO 9001:2008
CERTIFIED



Visit www.abracon.com for Terms & Conditions of Sale
30332 Esperanza, Rancho Santa Margarita, California 92688
tel 949-546-8000 | fax 949-546-8001 | www.abracon.com

Revised: 04.14.14