

ENERGIZER EN92

**AAA**

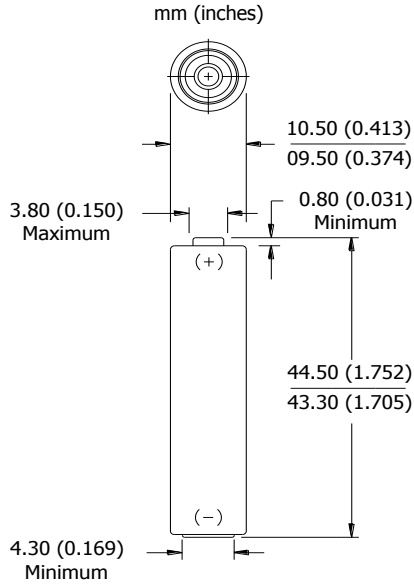

**Industry Standard Dimensions**



**Specifications**

**NOT INTENDED FOR RETAIL TRADE**

<b>Classification:</b>	Alkaline
<b>Chemical System:</b>	Zinc-Manganese Dioxide (Zn/MnO <sub>2</sub> ) No added mercury or cadmium
<b>Designation:</b>	ANSI-24A, IEC-LR03
<b>Nominal Voltage:</b>	1.5 volts
<b>Nominal IR:</b>	150 to 300 milliohms (fresh)
<b>Operating Temp:</b>	-18°C to 55°C (0°F to 130°F)
<b>Typical Weight:</b>	11.5 grams (0.4 oz.)
<b>Typical Volume:</b>	3.8 cubic centimeters (0.2 cubic inch)
<b>Jacket:</b>	Plastic Label
<b>Shelf Life:</b>	10 years at 21°C
<b>Terminal:</b>	Flat Contact

**Milliamp-Hours Capacity**

Continuous discharge to 0.8 volts at 21°C

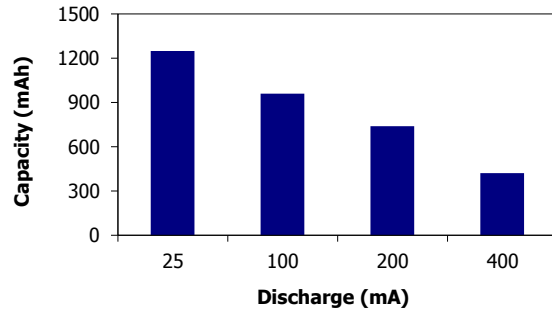

**Constant Power Performance**

Typical Characteristics (21°C)

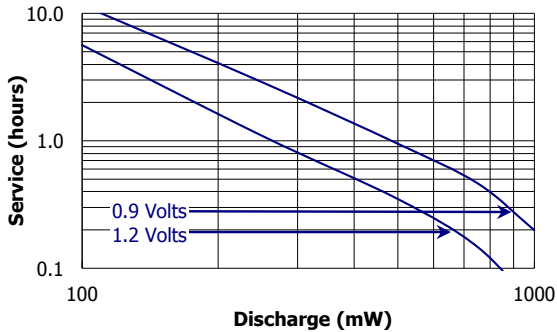

**Constant Current Performance**

Typical Characteristics (21°C)

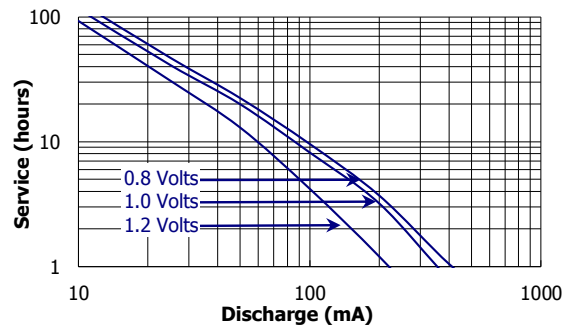

**Important Notice**

This data sheet contains typical information specific to products manufactured at the time of its publication.  
©Energizer Holdings, Inc. - Contents herein do not constitute a warranty.

ENERGIZER EN92



**Constant Power Performance**

Discharge Characteristics (21°C)

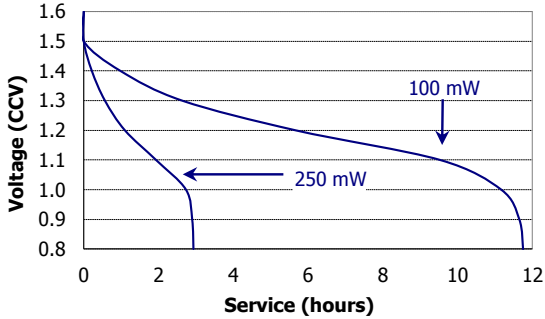

**Constant Current Performance**

250 mA Discharge (-20°C / 0°C / 21°C)

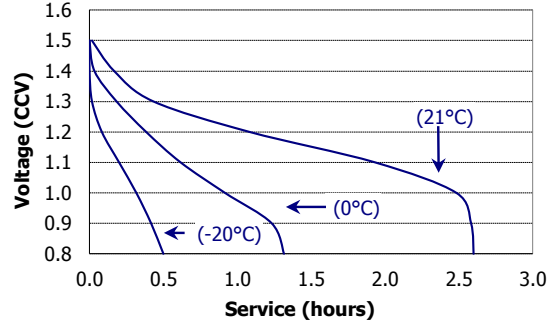

**Industry Standard Tests (21°C)**

**LIGHTING**  
5.1 ohm LIF

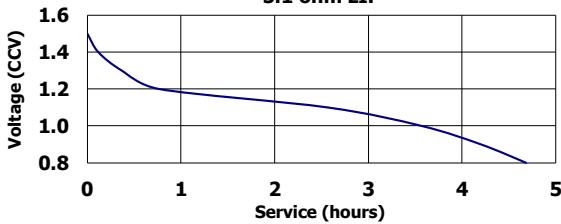

**REMOTE**  
24 ohm 15 sec/min 8 hrs/day

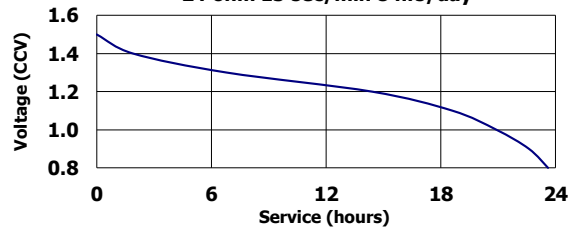

**TAPE-GAME-DIGITAL AUDIO**  
100 mA 1 hr/day

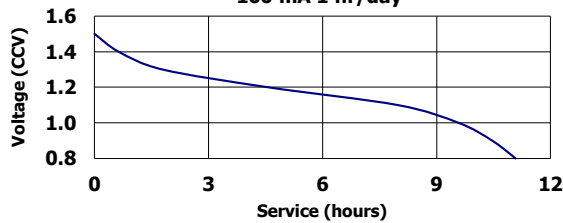

**PHOTOFLASH**  
600 mA 10 sec/min 1 hr/day

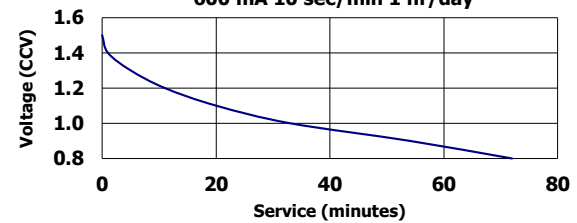

**Important Notice**

This data sheet contains typical information specific to products manufactured at the time of its publication.  
©Energizer Holdings, Inc. - Contents herein do not constitute a warranty.