

Quick Start Guide

TDTP4000W066B_0v1

Evaluation Platform
4kW bridgeless totem-pole PFC

transphorm

Highest Performance, Highest Reliability GaN

9/2017

Equipment Needed

- ➔ The TDTP4000W066B_Ov1 board
- ➔ Texas Instruments F28335 control card (included)
- ➔ High-voltage AC power supply for input
- ➔ 12V_{DC} auxiliary power adapter (included)
- ➔ Electronic/resistive load
 - Power range: 0W to 4400W



Cautions and Warnings

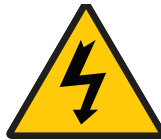

This evaluation board is intended to demonstrate GaN FET technology and is for demonstration purposes only and no guarantees are made for standards compliance.

There are areas of this evaluation board that have exposed access to hazardous high voltage levels. Exercise caution to avoid contact with those voltages. Also note that the evaluation board may retain high voltage temporarily after input power has been removed. Exercise caution when handling.

When testing converters on an evaluation board, ensure adequate cooling. Apply cooling air with a fan blowing across the converter or across a heatsink attached to the converter. Monitor the converter temperature to ensure it does not exceed the maximum rated per the datasheet specification.

See page 5 for operating guidelines.

Step 2: Power-up the Board

➔ Insert the control card

- LED1 ON indicates DSP power is on
- LED2 BLINKING indicates the DSP is running
- LED3 ON indicates the DSP has stopped running due to fault protection (over voltage or current)

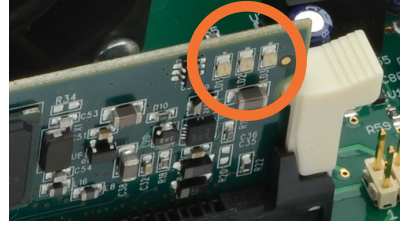

➔ Connect an electronic/resistive load to the corresponding marking (CN2). The requirements for the resistive load are:

- At 115V_{AC} input: 0W and ≤2200W
- At 230V_{AC} input: 0W and ≤4400W

➔ Connect the 12V_{DC} auxiliary supply (included) to the evaluation board

➔ Verify that both fans attached to the heatsink are running

➔ With high-voltage power off, connect the high-voltage AC power input to the corresponding marking (CN1) on the PCB; N and L (PE: potential ground)

➔ Turn on the AC power input (85V_{AC} to 265V_{AC}, 50Hz to 60Hz); minimum power load for turn-on sequence is 350W

➔ Monitor CN2 output voltage with V_{DC} meter to verify that 385V ±5V is generated

➔ Load can be increased when AC supply is on and board is functional

Step 3: Power-down the Board

➔ Switch off the high-voltage AC power input

➔ Power off the DC bias

Note:

See page 5 for important operating guidelines

Probing

There are four voltage probing sockets to measure V_{GS} and V_{DS} of the GaN FET and MOSFET low side, shown below.

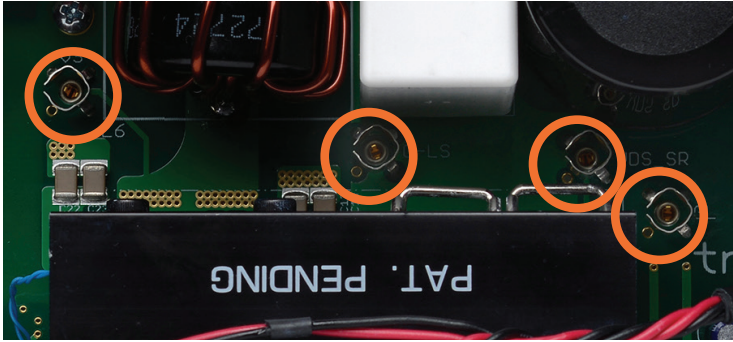
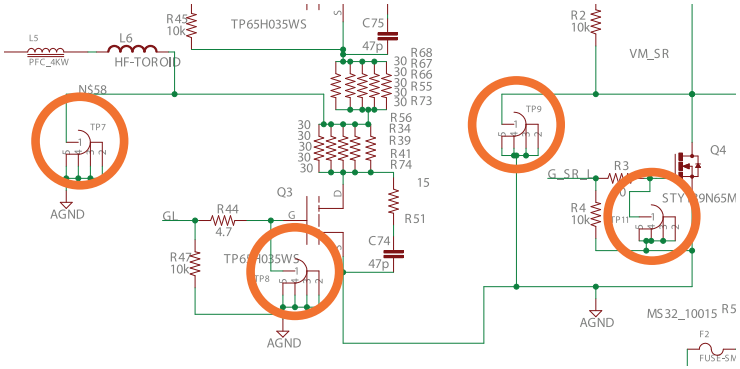

By removing the jumpers and using a short wire to clamp the current probe, the PFC inductor can also be measured.



Passive voltage probe

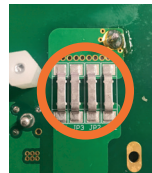

Remove jumpers and add a cable for inductor current measurement

Important Operating Guidelines

The TDTP4000W066B is for evaluation purposes only and is not intended to be a finished product and does not include all protection features found in commercial power supplies. Additional warnings to keep in mind:

- ➔ An isolated AC source should be used as input. An isolated lab bench-grade power supply or the included AUX DC supply should also be used for the 12V DC power supply. Float the oscilloscope by using an isolated oscilloscope or by disabling the PE (Protective Earth) pin in the power plug. Float the current probe power supply (if any) by disabling the PE pin in the power plug.
- ➔ Use a resistive load only. The totem-pole PFC kit can work at zero load with burst mode and the output voltage will be swinging between 375V and 385V during burst mode.
- ➔ The evaluation board is not fully-tested at large load steps. **DO NOT** apply a very large step in the load (>2000W) when it is running.
- ➔ **DO NOT** manually probe the waveforms when the board is running. Set up probing before powering up the demo board.
- ➔ The auxiliary V_{DC} supply must be 12V. The evaluation board will not work under 10V or over 15V V_{DC} , for example.
- ➔ **DO NOT** touch any part of the evaluation board when it is running.
- ➔ When plugging the control cards into the socket, make sure the control cards are fully pushed down with a clicking sound.
- ➔ If the evaluation circuit goes into protection mode it will work as a diode bridge by shutting down all PWM functions. Recycle the bias power supply to reset the DSP and exit protection mode.
- ➔ **DO NOT** use a passive probe to measure control circuit signals and power circuit signals at the same time. GND1 and AGND are not the same ground.
- ➔ To get clean V_{GS} of the low side GaN FET, it is not recommended to measure the V_{DS} at the same time.
- ➔ It is not recommended to use a passive voltage probe for V_{DS} and V_{GS} measurements while simultaneously using a differential voltage probe for V_{IN} measurements, unless the differential probe has very good dv/dt immunity.

Typical Performance Curves

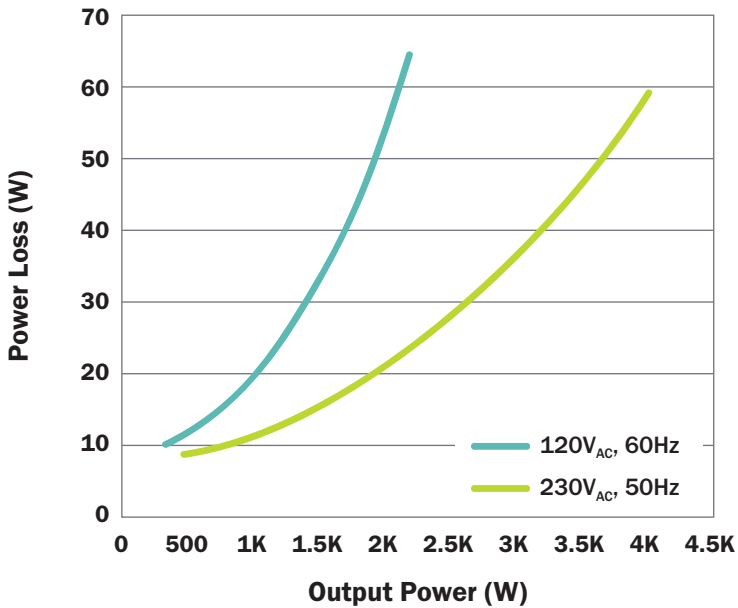
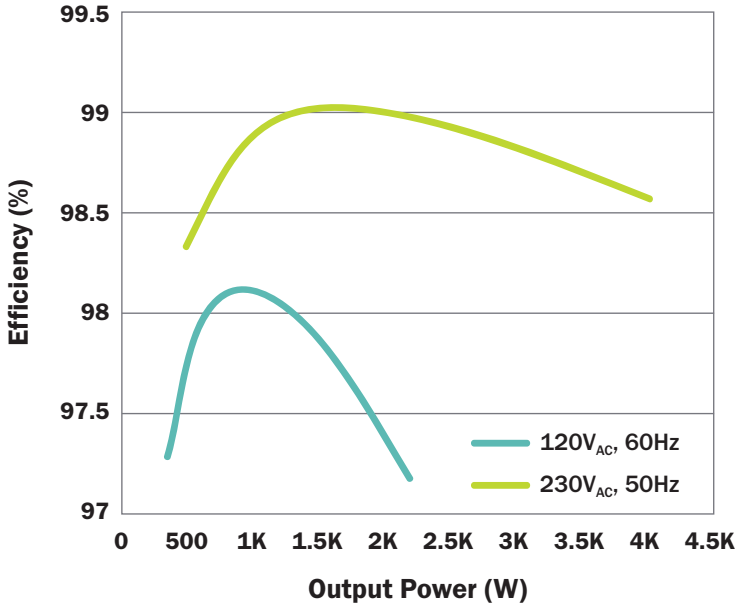



transphorm

+1 805 456 1300
transphormusa.com

TDTTP4000W066B_0v1
For evaluation purposes only

Design files and more at
transphormusa.com/tp4kit