

FEATURES

- ITE (2nd Ed.) and Medical (3rd ed.) MOPP safety approved
- 30-40W compact high density
- 2" x 4" standard footprint
- High efficiency up to 89%
- Universal AC input
- Low profile - 1U package
- Convection-cooled operation up to 40W
- Complies with 5000m altitude
- RoHS compliant
- UL Class I and II approved
- Less than 0.3W no load input power
- Complies with ErP/Energy Star requirement average efficiency > 85.3% (24V and 48V)

DESCRIPTION

The MVAD040 series switching power supplies utilize advanced component and circuit technologies to deliver high efficiency. Designed for Medical, Telecom, and Industrial applications to satisfy 1U height design considerations, the MVAD040 Series measures only 2.0" x 4.0" x 1.3". All models offer universal AC input and compliance to worldwide safety and EMC standards.

ORDERING GUIDE

Model Number	Natural Convection Cooling	Main Output (V1)
MVAD040-05	30W	5V
MVAD040-12		12V
MVAD040-24	40W	24V
MVAD040-48		48V

INPUT CHARACTERISTICS

Parameter	Conditions	Min.	Typ.	Max.	Units
Input Voltage Operating Range	Single phase	90	120/230	264	Vac
	DC	120		300	Vdc
Input Frequency		47	50/60	63	Hz
Turn-on Input Voltage	Input rising at full load	50		70	Vac
Turn-off Input Voltage	Input falling at full load	50		70	
Input Current	90Vac input, full load			0.9	A
Inrush Current	At 264Vac, at 25°C cold start		60		Apk

OUTPUT CHARACTERISTICS

Model Number	Main Output Voltage (V1)	Load Current	Peak Load ³	Load Capacitance	Line, Load, Cross Regulation	Typical Efficiency @230Vac full load
MVAD040-05	5V	0 to 6A		0 to 1200µF	± 2%	80%
MVAD040-12	12V	0 to 3.34A	5.0A	0 to 680µF	± 2%	87%
MVAD040-24	24V	0 to 1.67A	2.5A	0 to 330µF	± 2%	88%
MVAD040-48	48V	0 to 0.84A	1.25A	0 to 220µF	± 2%	89%

Main Output Characteristics (all models)

Parameter	Conditions	Min.	Max.	Units
Transient Response (MVAD040-05 only)	50% load step, 1A/µsec slew rate		± 8	%
Transient Response (all other models)		± 5		
Settling Time to 1% of Nominal			200	µsec
Turn On Delay	After application of input power		1	sec
Output Voltage Rise	Monotonic, 0 to 100% load		50	msec
Setpoint Accuracy	120Vac, 40W, 25°C		± 0.5	%
Output Holdup, MVAD040-05 only	115Vac, 100% load	20		msec
Output Holdup, all other models	115Vac, 100% load	15		msec
Temperature Coefficient			0.02	%/°C
Ripple Voltage & Noise ¹			1	%

1. Ripple and noise are measured with 0.1 µF of ceramic capacitance and 47 µF of electrolytic capacitance on each of the power supply outputs. The output noise requirements apply over a 0 Hz to 20 MHz bandwidth. A short coaxial cable with 50ohm scope termination is used.
2. Unless otherwise specified all readings are taken at 120Vac input and 25 °C ambient temperature.
3. Peak current lasting <15 seconds with a maximum 10% duty cycle and with an average output power of 40W.



Available now at www.murata-ps.com/en/3d/acdc.html



For full details go to www.murata-ps.com/rohs



ENVIRONMENTAL CHARACTERISTICS					
Parameter	Conditions	Min.	Typ.	Max.	Units
Storage Temperature Range		-40		85	°C
Operating Temperature Range	See thermal derating curves	-20		70	
	Start up	-20			
Operating Humidity	Non-condensing	10		95	%
Operating Altitude	For Class I ITE Equipment deployment	-200		5000	m
	Other	-200		2000	
MTBF	Telcordia SR-332 M1C3 25°C	1M			Hours
Shock	Operating, IEC60068-2-27, half-sine 5G, 6ms, 3 times per face, 6 faces	Complies			
	Non-operating, IEC60068-2-27, half-sine, 30G, 18ms, 3 times per face, 6 faces	Complies			
Vibration	Operating, IEC60068-2-6, 1.0G, 10-150Hz, 10minutes per axis, on all 3 axes	Complies			
	Non-operating, IEC60068-2-6, 2.0G, 10-150Hz, 10minutes per axis, on all 3 axes	Complies			
Safety	IEC60950-1:2005 (2nd Edition); Am1:2009 UL60950-1 2nd Edition,2011-12-19, CSA C22.2 No. 60950-1-07, 2nd Edition,2011-12 EN60950-1:2006 + A11:2009 + A1:2010 + A12:2011 IEC60601-1:2005 + CORR.1(2006) + CORR.2(2007) ANSI/AAMI ES60601-1 (2005+C1:09 + A2:10), CSA-C22.2 No. 60601-1(2008), MOPP CE Marking per LVD				
Warranty	2 years				
Outside Dimensions	2.0" x 4.0" x 1.3" (50.8mm x 101.6mm x 33.02mm)				
Weight	0.28lbs (127g) typical (MVAD040-05 only)				
	0.27lbs (123g) typical (all other models)				

PROTECTION CHARACTERISTICS					
Parameter	Conditions	Min.	Typ.	Max.	Units
Overvoltage Protection	Latching (60% load)	110		160	%V1
Overcurrent Protection, MVAD040-05 only	Hiccup mode	110		160	%A
Overcurrent Protection, all other models	Hiccup mode	170		240	%A

ISOLATION CHARACTERISTICS					
Parameter	Conditions	Min.	Typ.	Max.	Units
Isolation	Primary to Earth Ground (1xMOPP)	1500			Vac
	Primary to Secondary (2xMOPP)4	4000			
	Secondary to Earth Ground	500			Vdc
Leakage Current (under normal conditions)	240Vac, 60Hz, 25°C			300	µA
	264Vac, 60Hz, 25°C			350	
Touch Current	264Vac, 60Hz, 25°C			100	

EMISSIONS AND IMMUNITY		
Characteristic	Standard	Compliance
Input Current Harmonics	IEC/EN 61000-3-2	Class A
Voltage Fluctuation and Flicker	IEC/EN 61000-3-3	Complies
Conducted Emissions	EN 55022	Class B, Class A (at Class II equipment)
	FCC Part 15	Class B, Class A (at Class II equipment)
ESD Immunity	IEC/EN 61000-4-2	Level 4, Criterion A
Radiated Field Immunity	IEC/EN 61000-4-3	Level 2, Criterion A
Electrical Fast Transient Immunity	IEC/EN 61000-4-4	Level 3, Criterion A
Surge Immunity	IEC/EN 61000-4-5	Level 4, Criterion A
RF Conducted Immunity	IEC/EN 61000-4-6	Level 2, Criterion A
Magnetic Field Immunity	IEC/EN 61000-4-8	Level 2, Criterion A
Voltage dips, interruptions	IEC/EN 61000-4-11	Level 3, Criterion B

4. At class I equipment.

EMI CONSIDERATIONS

For optimum EMI performance, the power supply should be mounted to a metal plate grounded to all 4 mounting holes of the power supply. To comply with safety standards, this plate must be properly grounded to protective earth (see mechanical dimension notes). Pre-compliance testing has shown the stand-alone power supply to comply with EN55022 class A radiated emissions. Radiated emission results vary with system enclosure and cable routing paths.

SAFETY CONSIDERATIONS



1. This power supply is a component level power supply intended for use in class I or class II applications. Secondary ground traces need to be suitably isolated from primary ground traces when used in class II applications.
2. When the power supply is used in class II equipment, all ground traces and components connected to the primary side are considered primary for spacing and insulation considerations.
3. Double pole/neutral fusing.

PERFORMANCE DATA

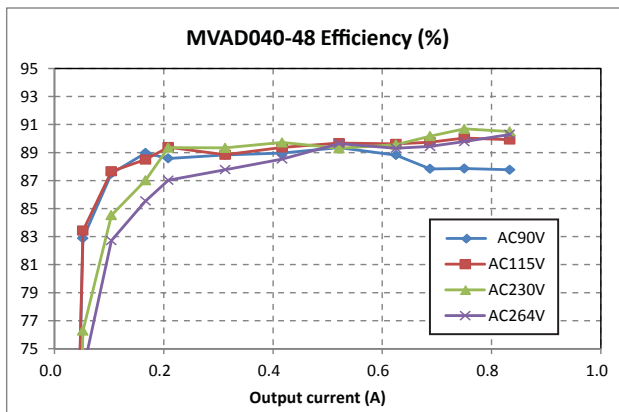
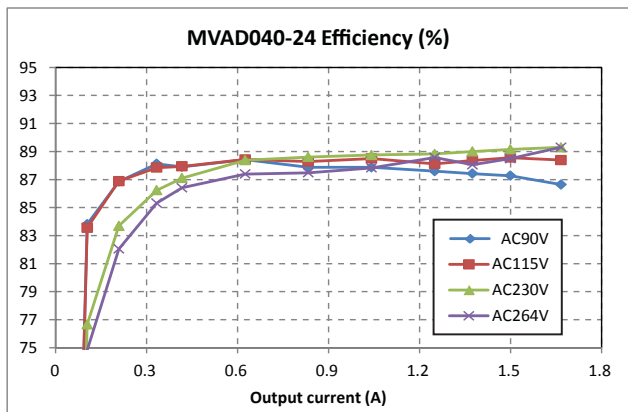
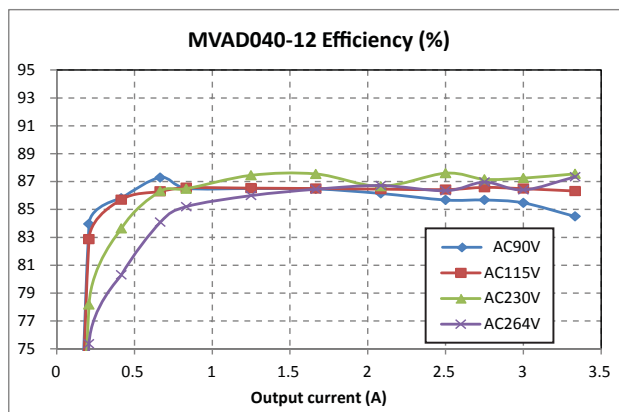
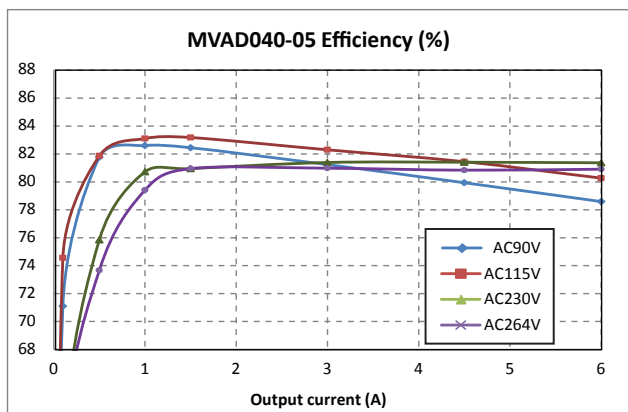

Inrush waveform (AC264V 25°C)

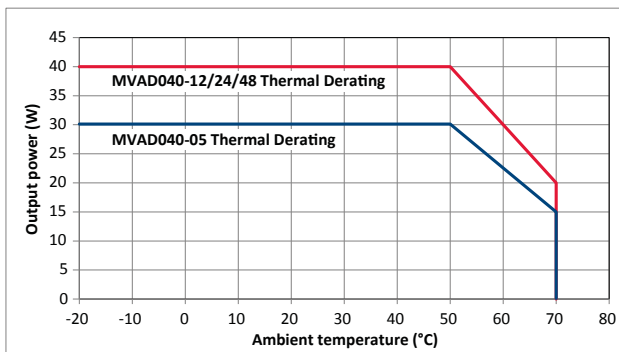
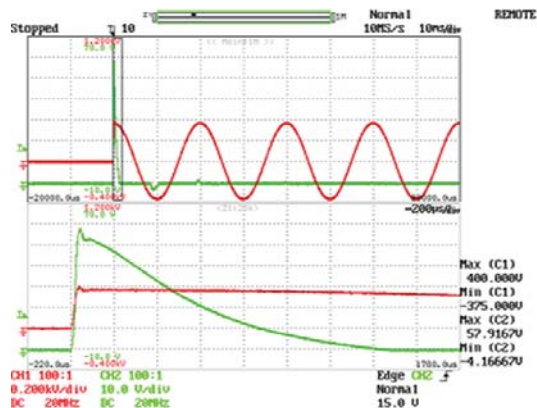

MECHANICAL DIMENSIONS – MVAD040-05 ONLY

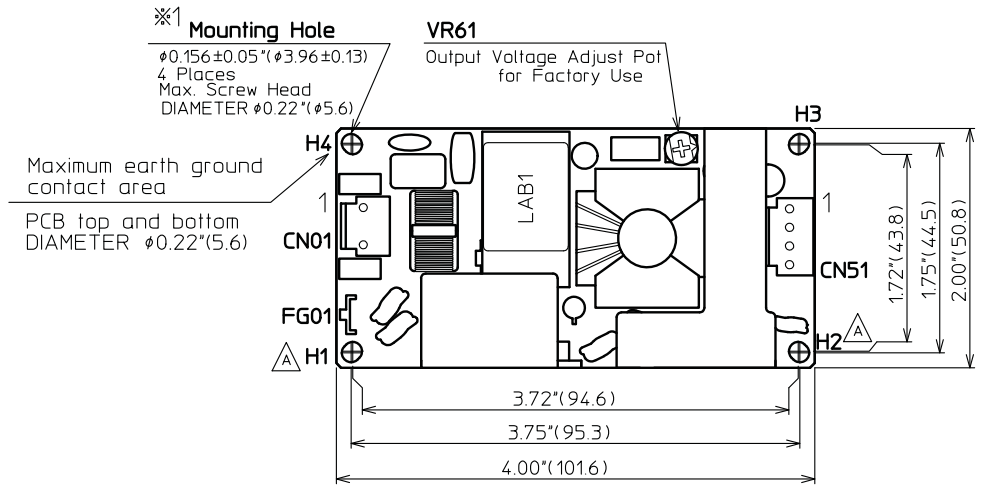

※1 Preferred screw type :
M3 (Metric screw threads)
No.4-40UNC (Unified Thread Standard)

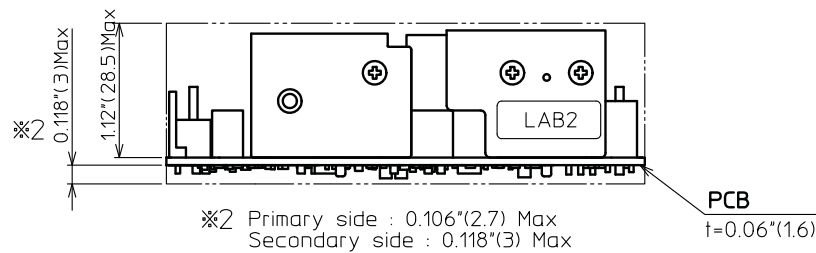

All dimensions in inches (mm), tolerance is +/-0.02' (0.5)
Mounting holes H1 and H2 should be earth-grounded for EMI purpose
Mounting holes H2 is earth ground connection
This power supply requires mounting on standoffs minimum 0.2' (5.0) in height

Dimensions: 2.0" x 4.0" x 1.3" (50.8mm x 101.6mm x 33.02mm)

INPUT/OUTPUT CONNECTOR AND SIGNAL SPECIFICATION AND MATING CONNECTORS

PIN	Description	Mating Housing	Crimp terminal/pins
Input Connector CN1 : Molex 26-62-4030			
1	AC Line (V-)	Molex 09-50-8031 with locking ramp	Molex 6838 Series
3	AC Neutral (V+)		
Spade Connector: #250			
GND	Earth Ground		
Output Connector CN2 : Molex 26-60-4040			
1, 2	V1	Molex 09-50-8041 with locking ramp	Molex 6838 Series
3, 4	DC Return		

MECHANICAL DIMENSIONS – MVAD040-12 ONLY

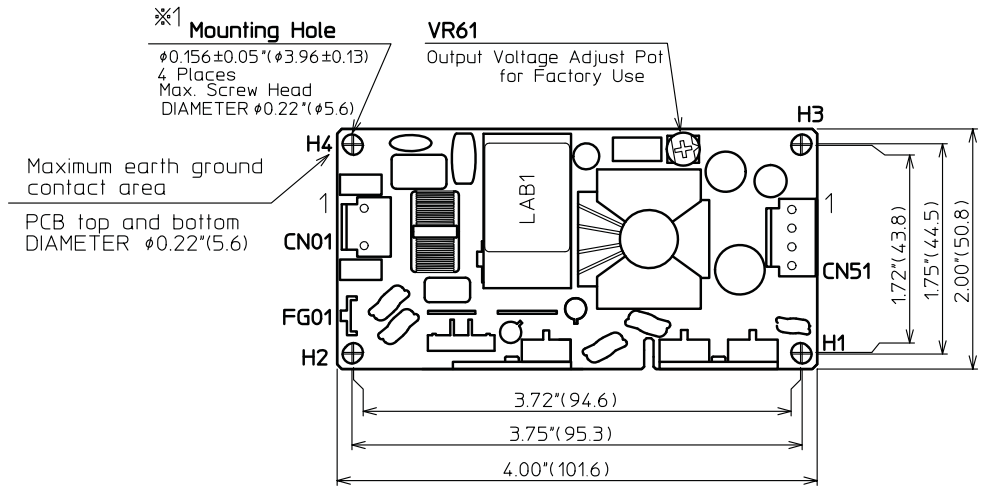

※1 Preferred screw type :
 M3 (Metric screw threads)
 No.4-40UNC (Unified Thread Standard)

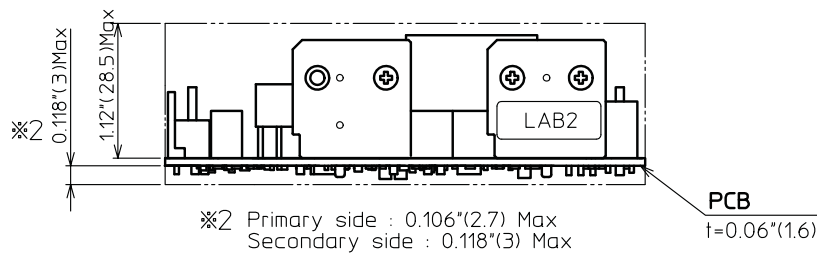

All dimensions in inches (mm), tolerance is +/-0.02' (0.5)
 Mounting holes H1 and H2 should be earth-grounded for EMI purpose
 Mounting holes H2 is earth ground connection
 This power supply requires mounting on standoffs minimum 0.2" (5.0) in height

Dimensions: 2.0" x 4.0" x 1.3" (50.8mm x 101.6mm x 33.02mm)

INPUT/OUTPUT CONNECTOR AND SIGNAL SPECIFICATION AND MATING CONNECTORS

PIN	Description	Mating Housing	Crimp terminal/pins
Input Connector CN1 : Molex 26-62-4030			
1	AC Line (V-)	Molex 09-50-8031 with locking ramp	Molex 6838 Series
3	AC Neutral (V+)		
Spade Connector: #250			
GND	Earth Ground		
Output Connector CN2 : Molex 26-60-4040			
1, 2	V1	Molex 09-50-8041 with locking ramp	Molex 6838 Series
3, 4	DC Return		

MECHANICAL DIMENSIONS – MVAD040-xx 24V and 48V MODELS

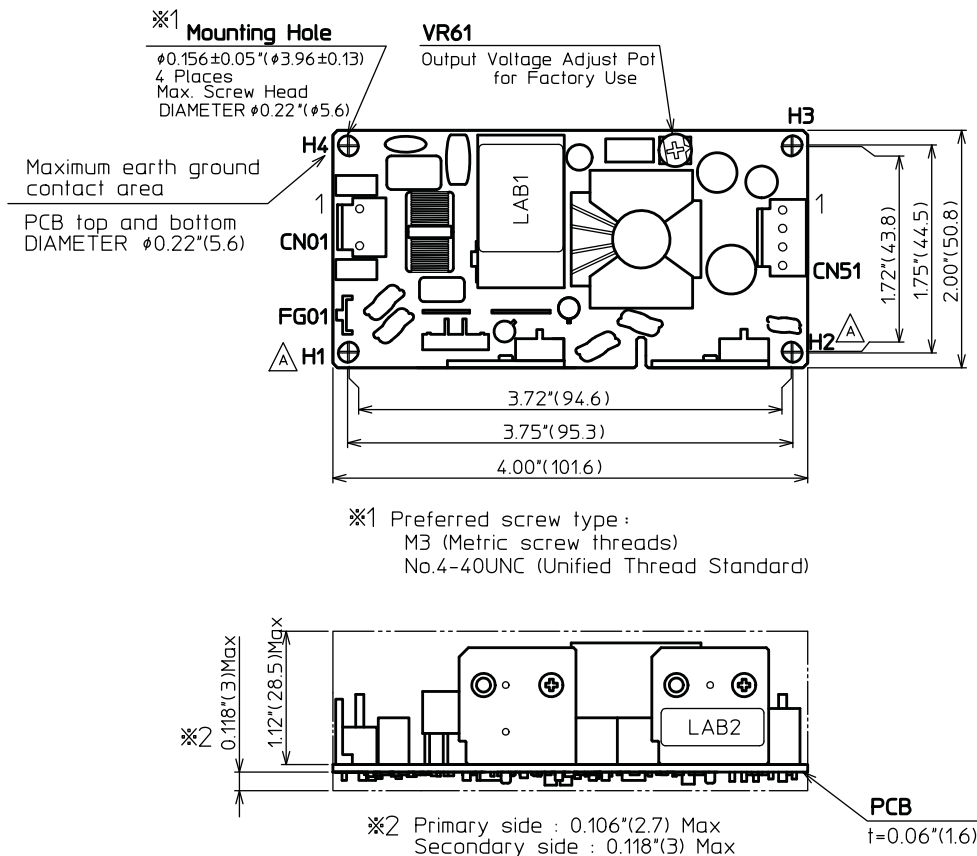

All dimensions in inches (mm). tolerance is +/-0.02' (0.5)
 Mounting holes H1 and H2 should be earth-grounded for EMI purpose
 Mounting holes H2 is earth ground connection
 This power supply requires mounting on standoffs minimum 0.2' (5.0) in height

Dimensions: 2.0" x 4.0" x 1.3" (50.8mm x 101.6mm x 33.02mm)

INPUT/OUTPUT CONNECTOR AND SIGNAL SPECIFICATION AND MATING CONNECTORS

PIN	Description	Mating Housing	Crimp terminal/pins
Input Connector CN1 : Molex 26-62-4030			
1	AC Line (V-)	Molex 09-50-8031 with locking ramp	Molex 6838 Series
3	AC Neutral (V+)		
Spade Connector: #250			
GND	Earth Ground		
Output Connector CN2 : Molex 26-60-4040			
1, 2	V1	Molex 09-50-8041 with locking ramp	Molex 6838 Series
3, 4	DC Return		

Murata Power Solutions, Inc.
 11 Cabot Boulevard, Mansfield, MA 02048-1151 U.S.A.
 ISO 9001 and 14001 REGISTERED



This product is subject to the following operating requirements and the Life and Safety Critical Application Sales Policy. Refer to: <http://www.murata-ps.com/requirements/>

Murata Power Solutions, Inc. ("Murata") makes no representation that the use of its products in the circuits described herein, or the use of other technical information contained herein, will not infringe upon existing or future patent rights. The descriptions contained herein do not imply the granting of licenses to make, use, or sell equipment constructed in accordance therewith. Buyer represents and agrees that it has all the necessary expertise to create and implement safeguards that anticipate dangerous consequences of failures, monitor failures and their consequences, lessen the likelihood of failures that might cause harm, and take appropriate remedial actions. Buyer will fully indemnify Murata, its affiliated companies, and its representatives against any damages arising out of the use of any Murata products in safety-critical applications. Specifications are subject to change without notice. © 2014 Murata Power Solutions, Inc.