

HN-210/210X

**Outdoor Base
Remote**



User Guide

Revision History

Revision	Date	Author	Change Description
1	2004	F. Perkins	Initial issue
2	01/13/2017	R. Willett	Updated Copyright and format for new Murata V.I.

Important Regulatory Information

**Cirronet Product FCC ID: HSW-2410
IC 4492A-2410**

Note: This unit has been tested and found to comply with the limits for a Class A digital device, pursuant to part 15 of the FCC Rules. These limits are designed to provide reasonable protection against harmful interference when the equipment is operated in a commercial environment. This equipment generates, uses, and can radiate radio frequency energy and, if not installed and used in accordance with the instruction manual, may cause harmful interference to radio communications. Operation of this equipment in a residential area is likely to cause harmful interference in which case the user will be required to correct the interference at their expense.

FCC s MPE Requirements

Information to user/installer regarding FCC s Maximum Permissible Exposure (MPE) limits.

Notice to users/installers using the 24 dBi parabolic dish antenna in conjunction with all Cirronet RF products.

FCC rules limit the use of this antenna, when connected to Cirronet RF products for **point-to-point applications only**. It is the responsibility of the installer to ensure that the system is prohibited from being used in point-to-multipoint applications, omni-directional applications, and applications where there are multiple co-located intentional radiators transmitting the same information. Any other mode of operation using this antenna is forbidden.

Notice to users/installers using the following fixed antennas, with Cirronet RF products:

<p>Andrews 24dBi parabolic dish Andrews 18dBi parabolic dish Cushcraft 15dBi Yagi, Mobile Mark 14dBi Corner Reflector, Mobile Mark 9dBi Corner Reflector</p>	<p>The field strength radiated by any one of these antennas, when connected to Cirronet RF products, may exceed FCC mandated RF exposure limits. FCC rules require professional installation of these antennas in such a way that the general public will not be closer than 2 m from the radiating aperture of any of these antennas. End users of these systems must also be informed that RF exposure limits may be exceeded if personnel come closer than 2 m to the apertures of any of these antennas.</p>
--	--

Notice to users/installers using the following mobile antennas, with Cirronet RF products:

<p>Mobile Mark 12dBi omni-directional, Mobile Mark 9dBi omni-directional, MaxRad 5dBi whip, Cirronet Patch antenna, Ace 2dBi dipole, Mobile Mark 2dBi Stub</p>	<p>The field strength radiated by any one of these antennas, when connected to Cirronet RF products, may exceed FCC mandated RF exposure limits. FCC rules require professional installation of these antennas in such a way that the general public will not be closer than 20 cm from the radiating aperture of any of these antennas. End users of these systems must also be informed that RF exposure limits may be exceeded if personnel come closer than 20 cm to the apertures of any of these antennas.</p>
--	--

Declaration of Conformity



Warning! The RLAN transceiver within this device uses a band of frequencies that are not completely harmonized within the European Community. Before using, please read the European Operation Section of the Products User's Guide for limitations.

0560 is the identification number of TELEFICATION B.V., Utrechtseweg 310, NL-6800 JA ARNHEM - Netherlands
– the Notified Body having performed part or all of the conformity assessment on the product.

The WIT2410 to which this declaration relates is in conformity with the essential requirements of the R&TTE directive 1999/5/EC and complies with the following standards and/or other normative documents:

For Interfaces

EN 55022

EN 55024

For RLAN Transceiver

EN 300 328

EN 301 489 -1, -17

EN 60950

Use Within the European Union

The WIT2410 is intended for use within the European Community States and in the following non-European Union States: Norway & Switzerland

Use of the WIT2410 in France

When used in France, the WIT2410 can only be operated with the France hopping pattern selected. This is accomplished by setting the **pe** parameter to 1. Refer to *European Union Settings* in this manual for details.

Canadian Department of Communications Industry Canada (IC) Notice

Canadian Department of Communications Industry Canada (IC) Notice

This apparatus complies with Health Canada's Safety Code 6 / IC RSS 102.

"To prevent radio interference to the licensed service, this device is intended to be operated indoors and away from windows to provide maximum shielding. Equipment (or its transmit antenna) that is installed outdoors may be subject to licensing."

ICES-003

This digital apparatus does not exceed the Class B limits for radio noise emissions from digital apparatus as set out in the radio interference regulations of Industry Canada.

Le présent appareil numérique n'émet pas de bruits radioélectriques dépassant les limites applicables aux appareils numériques de Classe B prescrites dans le règlement sur le brouillage radioélectrique édicté par Industrie Canada.

Table of Contents

Introduction	6
HOPNET BENEFITS	6
Operating Frequency	6
HopNet Frequency Hopping Spread Spectrum Advantages	6
HopNet Data Integrity.....	7
Flexible Power Management.....	7
ADVANCED FEATURES.....	7
THE HOPNET FAMILY OF PRODUCTS	8
External Antenna.....	8
Built-In Antenna.....	8
Accessories.....	8
Getting Started	9
INSTALL THE HOPNET CONFIGURATION WIZARD ON A PC.	9
CONNECT THE HN-210 TO THE PC.	9
SET ONE HN-210 TO ACT AS THE BASE.....	10
RUN A COMMUNICATIONS TEST.....	12
THE SERIAL ADAPTER BOX.....	13
3 Wire Operation	14
Remote Pin-Out, RS-232	14
GUIDELINES FOR INSTALLATION.....	15
AIMING THE ANTENNA AND PLACING THE REMOTE	15
INTERCONNECT CABLE	15
Configuring the Network.....	16
HOPNET CONFIGURATION WIZARD (5.0 OR LATER).....	16
ABOUT THE INIT.INI FILE	18
Parameters Tab	19
Protocol Tab.....	26
RF Tools	28
WinCom Window.....	32
Function Keys	35
Recover.....	35
Restart	36
SAVING CONFIGURATIONS	36
Configuration Commands.....	37
SERIAL COMMANDS	38
NETWORK COMMANDS	40
PROTOCOL COMMANDS.....	43
STATUS COMMANDS	46
MEMORY COMMANDS.....	48
MODEM COMMAND SUMMARY.....	49
Troubleshooting	50
OVERVIEW	50
Introduction	50
Transceiver Requirements	50
COMMON SYSTEM PROBLEMS	51

GUIDELINES FOR REDUCING INTERFERENCE	52
Introduction	52
Guidelines for Setting Up the Network	52
Guidelines for Selecting Your Site.....	52
GUIDELINES FOR AVOIDING TERRAIN OBSTRUCTIONS	53
CUSTOMER SUPPORT	54
Introduction	54
Technical Assistance	54
Factory Repairs.....	54
Technical Specifications.....	55
Electrical	55
Mechanical.....	56
Environmental	56
Glossary of Terms.....	57
Warranty.....	58

Introduction

The HopNet 10 Series family of products provides reliable wireless connectivity for either point-to-point or point-to-multipoint applications. HopNet products are built around the WIT2410 radio transceiver, which employs frequency hopping spread spectrum technology. This technology ensures:

- Maximum resistance to noise
- Maximum resistance to multipath fading
- Robustness in the presence of interfering signals

The HN-210 and HN-210X are NEMA 4X weatherproof versions of the HopNet product line. The HN-214, which is an HN-210 with a 4 ft. cable, is also available. The interface to the 210 and 210X allows the Host to communicate with the Remote unit through an integrated 50 ft (15 meter) cable. The HN-210 and 210X can act as either bases or remotes.

The HN-210 Remote has an internally mounted 6 dBi patch antenna. The built-in antenna of the HN-210 case greatly eases outdoor installation since no antenna feedline cable or adapters are needed. The 6 dBi antenna gain increases the radiated EIRP to +24 dBm and the effective receiver sensitivity to -99 dBm. The HN-210X has a TNC connector for attaching an external antenna and a mounting kit (part no.: HN210X-MKIT) that accommodates both the HN-210X and any of the following external antennas:

CORNER249

CORNER2414

OMNI249

OMNI2412

HopNet Benefits

The HopNet family of products is built with rugged enclosures compliant with IP 66 and NEMA 4X standards for outdoor and harsh industrial environments. All Hopnet products work with each other and can be mixed and matched in a single network. All HopNet Products are WIT2410 compatible and can be used with WIT2410 OEM based products as well as with the SNAP2410 10Base T access point.

Operating Frequency

The HopNet family operates in the 2.4 GHz ISM band that allows for license-free use and worldwide compliance.

HopNet Frequency Hopping Spread Spectrum Advantages

In the frequency domain, a multipath fade can be described as a frequency selective notch that shifts in location and depth over time. Multipath fades typically occupy five percent of the band. A conventional radio system typically has a five percent chance of signal impairment at any given time due to multipath fading.

Frequency Hopping Spread Spectrum reduces the vulnerability of a radio system to interference from jammers and multipath fading by distributing or spreading the signal over a larger region of the frequency band.

The fade resistant, HopNet frequency-hopping technology employs up to 75 channels and switches channels over 100 times a second to achieve high reliability throughput.

HopNet Data Integrity

An on-board 3 KB buffer and error correcting over-the-air protocol ensure data integrity even in the presence of weak signals or jammers. The serial interface handles both data and control of asynchronous data rates of up to 230 Kbps.

Flexible Power Management

The power can be set at 10 milliwatts or 100 milliwatts using the included software. Reduced power can reduce the size of the coverage zone, which may be desirable for multiple network indoor applications. You can also place the transceiver module in a power-save mode, which enables smart power management. Smart power management allows a remote unit to drop into a lower current standby mode during transmission or receiving gaps.

This feature also allows Hopnet products to be used in various countries where the output power requirements may vary due to regulation.

Advanced Features

HopNet modems have many advanced features:

- Employ frequency hopping technology with up to 75 channels in the 2401 to 2475 MHz frequency range
- Support digital addressing for up to 64 networks, with 62 remotes per network.
- Use transparent ARQ protocol
- Use same hardware for all supported data rates
- Supports up to 115 Kbps asynchronous data rates
- Full Duplex operation
- Store setup configuration in nonvolatile memory (FLASH)
- Fast acquisition – less than 2 seconds is the typical time to acquire hopping pattern
- Smart power management features

The HopNet Family of Products

The HopNet family consists of the following products:

HN-210

HN-210X

HN-210D

HN-214

HN-214X

HN-210DX

HN-214D

HN-214DX

HN-510

SNAP2410

SNAP2410X

SNAP2410D

SNAP2410DX

External Antenna

HN-210X Base/Remote Unit

Built-In Antenna

HN-210 Base/Remote Unit

Accessories

Antennas

Adapter

Power Supplies

Getting Started

A pair of HN-210s is set up by performing the following steps:

- Install the HopNet Wizard configuration program on a PC
- Connect the HN-210 to the PC
- Set one HN-210 as a base radio
- Run a communications test

These steps are described in detail below. Other steps you may want to perform include:

- Change the baud rate
- Change the radio network number
- Change how fast the radios change frequencies

Refer to the *Configuring the Network* section of this manual for details on these steps.

Install the HopNet Configuration Wizard on a PC.

The HopNet Configuration Wizard is located on the software and documentation CD included in the HN-210 package. Install the program by inserting the CD in the PC and following the installation wizard. If Autorun has been turned off, double-click on setup.exe on the CD to start the wizard.

Connect the HN-210 to the PC.

Connect the serial adapter box to a serial port on the PC using the serial cable provided.

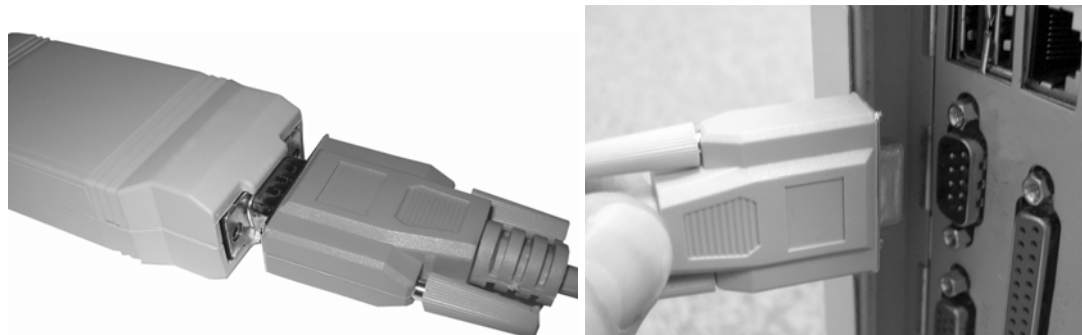

Connect the end of the cable from the HN-210 (RJ45 connector) to the small serial adapter box.

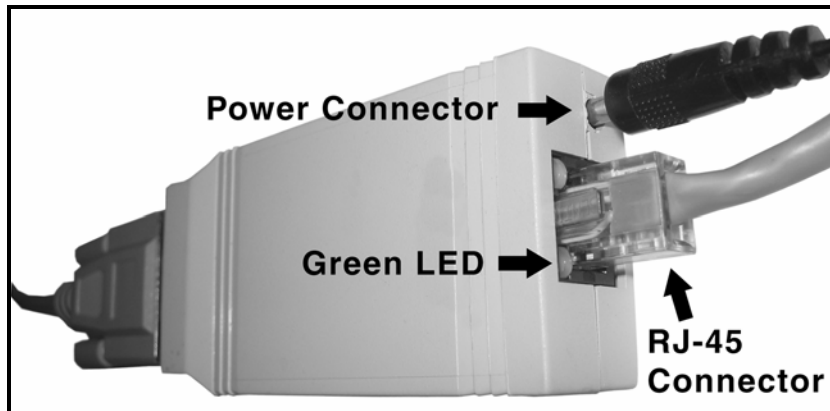

Connect power to the HN-210 by plugging one end of the wall-mount power supply into the serial adapter box and the other end into a wall outlet. A green LED on the serial adapter box will turn on indicating power is present.

Set one HN-210 to act as the base.

When using HN-210s, one unit, and only one, must be set as the base. All other HN-210s must be set as remotes. With an HN-210 connected to the PC, start the HopNet Configuration Wizard program by double-clicking on the icon on the desktop. The HopNet Configuration Wizard will automatically detect which serial port the HN-210 is connected to and the baud rate of the HN-210. When the radio has been detected, the Continue button will appear.



Click on the Continue button to bring up the next screen.

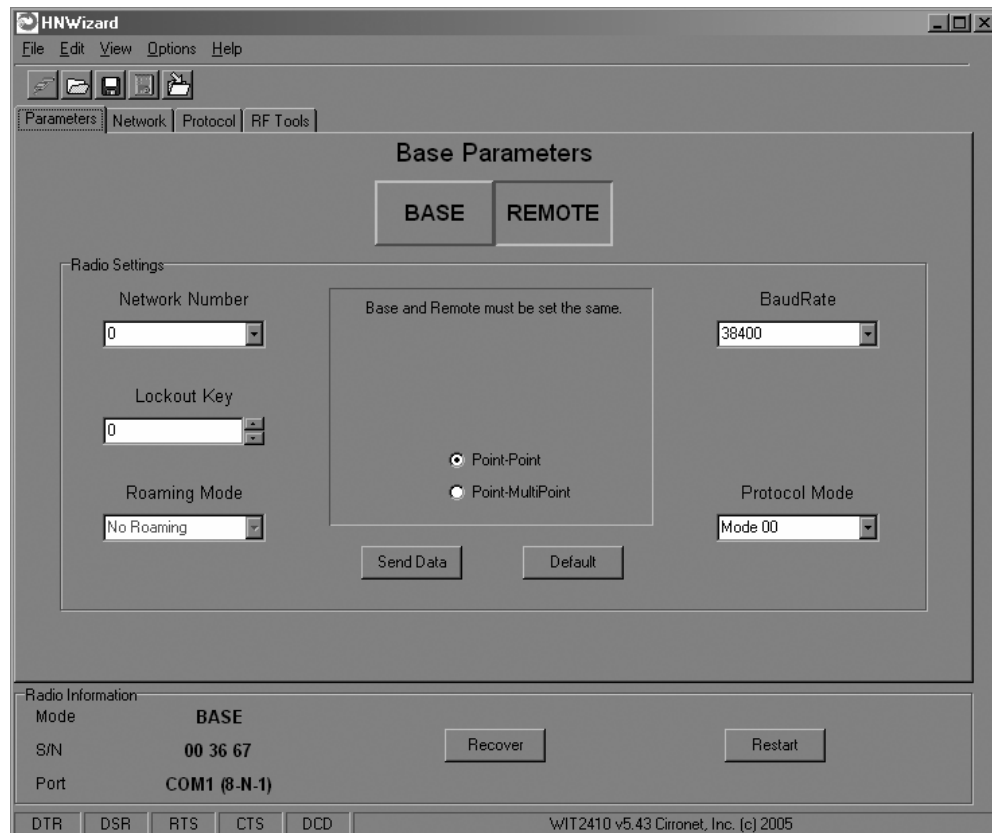

The program will read and display the current settings of the HN-210. The HN-210 is shipped from the factory as a remote. The Remote button on the Wizard screen will appear depressed indicating the HN-210 is a remote.

NOTE: The S/N displayed in the bottom left corner is the serial number of the radio inside the unit and is different from the serial number of the HopNet unit. Both the HopNet unit serial number and the radio serial number are on the radio unit of the HopNet product.

To set the HopNet radio as a base, click on the Base button. The Base button will depress and the Remote button will pop up. The screen heading will change from “Remote Parameters” to “Base Parameters.”

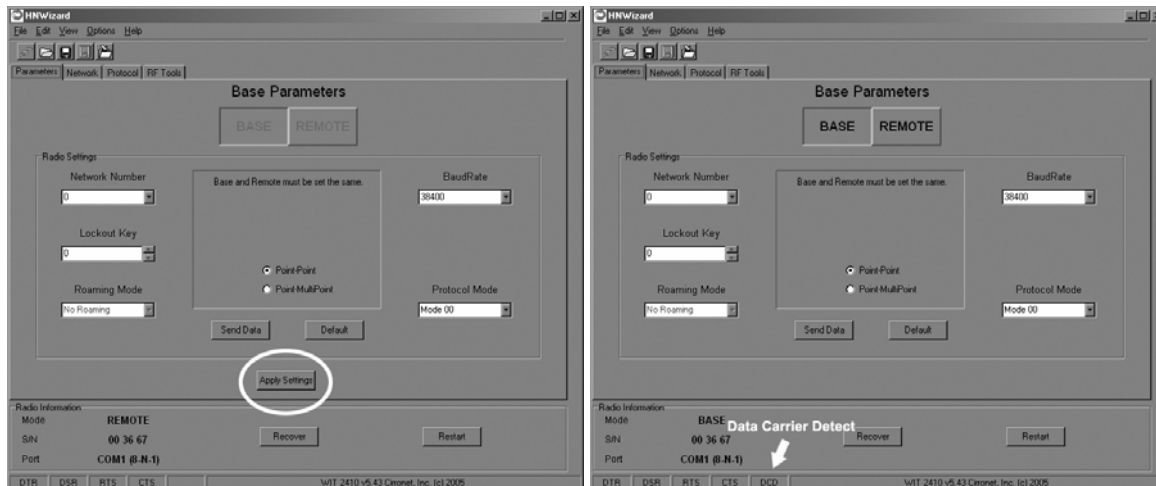

The Apply Settings button will appear at the bottom of the HopNet Configuration Wizard screen. Click on the Apply Settings button to set the HopNet radio as the base.

Run a communications test.

To run a communications test, connect one HopNet radio set as a base to one PC running the Wizard and another HopNet radio set as a remote to another PC running the Wizard. Verify that the Carrier Detect LED (CD) on the radio is on (red), the fifth parameter box on the lower left of the window will have DCD (as shown above right). Click on the Send Data button on the HopNet Configuration Wizard screen on both PCs. The HopNet radio set up as the base will send the message “This is a test message from the Base radio.” to the remote HopNet radio. This message will be displayed in the message window of the Wizard running on the remote PC. The remote HopNet radio will send the message “This is a test message from the Remote radio.” to the base HopNet radio. This message will be displayed in the message window of the Wizard running on the base PC. The test will run continuously until the Stop button is clicked.

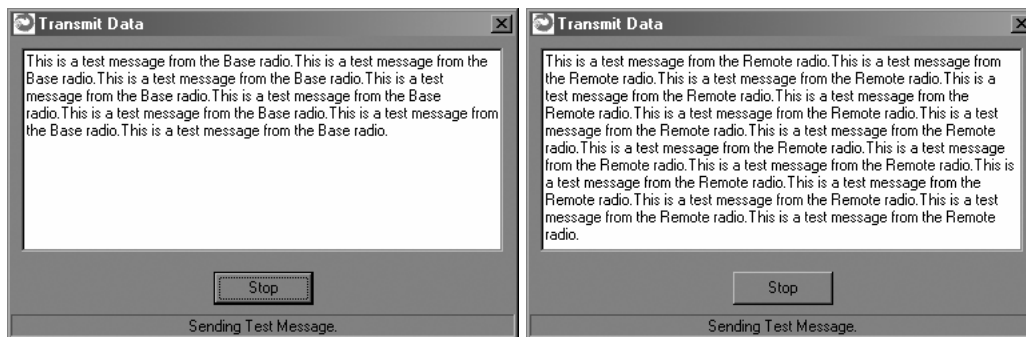

NOTE: If your computer has two serial ports, both the base and the remote HopNet radios can be connected to the same PC and the communications test run by opening a second window running the Wizard. Open the second window by simply double-clicking on the Wizard icon on your desktop.

The Serial Adapter Box

The HN-210 and HN-210X remotes interface with the user's hardware through a serial adapter box. The interface adapter supplies power and signal to the remote unit. The interface to the remote unit is a standard RS-232 DB-9 serial interface. To have all functions of the HN-210 available, including configuration and hardware flow control, the eight signal lines must be connected. The HN-210 serial connector is set up as a DCE device. This allows communication with a PC using the straight through serial cable provided with the HN-210. To connect the HN-210 to another DCE device, a cross-over cable must be used. The connector pin-out is detailed in the figure and table below.

3 Wire Operation

If configuration and hardware flow control is not necessary, the HN-210 can be used in 3-wire mode. In this mode, only Ground, Receive Data and Transmit data are connected

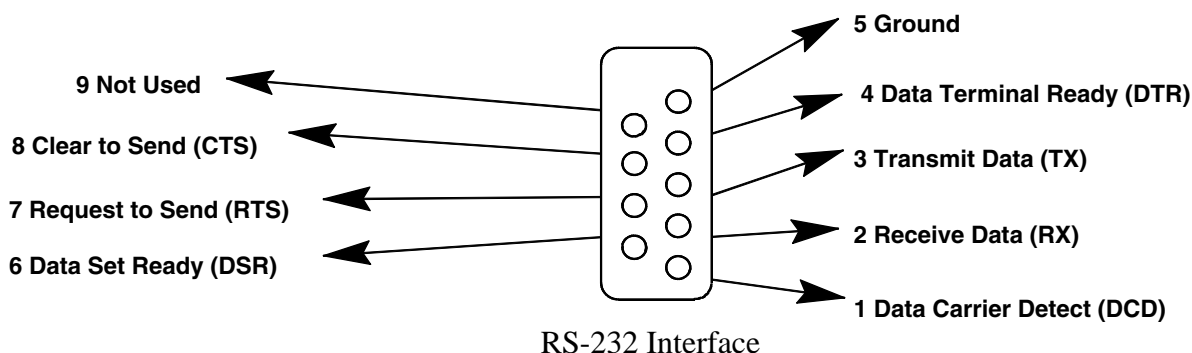

Remote Pin-Out, RS-232

Pin Number	Signal	Type	Description
1	DCD	Output	Data Carrier Detect. For remotes, DCD indicates that the remote has successfully acquired the hopping pattern.
2	RXD	Output	Output for received serial data.
3	TXD	Input	Input Serial Data to be transmitted
4	DTR	Input	Data Terminal Ready. Sleep/ wakes radio transceiver.
5	GND	-	Signal and Chassis Ground
6	DSR	Output	Data Set Ready. Response to DTR.
7	RTS	Input	Request to Send. Gates the flow of receive data from the radio to the user on or off. In normal operation signal should be asserted.
8	CTS	Output	Clear to Send. Used to control transmit flow from the user to the user to the radio. The WIT 2410 radio module supports hardware flow control only and does not support software flow control (e.g. Xon-Xoff).
9	Not Used	-	Not Used

Note: When the HN-210 and HN-210X are used as three wire serial devices, DTR and RTS do not have to be used.

Guidelines for Installation

When installing your system, always consider the following points:

Directional antennas are best for remote unit sites. They may increase the cost, but they confine the transmission path to a narrow lobe and minimize the interference from nearby stations.

For systems with constant interference present, you may need to change the polarity of the antenna system and reduce data streams. Groups of short data streams are more reliable and have a better chance of success in the presence of interference than do long data streams.

Systems installed in rural areas are least likely to encounter urban interference.

Multiple HopNet systems can operate in close proximity to each other but require a unique network address.

Poor quality coaxial cables will seriously degrade system performance. Use low-loss cable that is suitable for 2.4 GHz operation.

Short cable runs minimize signal loss.

Aiming the Antenna and Placing the Remote

Use the following guidelines for aiming the antenna and placing the Remote.

Do not place anything immediately in front of the antenna that could obstruct its radiation pattern. Because the antenna in the HopNet Remote is inside the unit, the antenna must have a clear line of sight.

Use the sticker on the HN-210 Remote unit to help you locate and aim the antenna. The sticker indicates which direction the antenna is pointing.

Be sure the antenna end of the HN-210 Remote faces the Base or Repeater that it is communicating with. Our tests have found that antenna placement is not critical as long as the patch antenna is facing in the general direction of the other end of the link. If possible, place the Remote unit at a higher elevation than the structures surrounding it to increase range and link reliability. Since the Remote will operate with up to 100 feet of interconnect cable between it and the Host, you can mount the unit on top of a building or other structure that will provide higher elevation.

Interconnect Cable

The HN-210 and HN-210X come with 50' (15 meters) of high quality interconnect cable. The cable may be lengthened by adding an additional 50' cable (part no.: CBLEXT50). The maximum cable length that the HN-210 and HN-210x will support is 100' (30 meters).

Configuring the Network

You can configure the HopNet network using a PC and the HopNet Configuration Wizard software provided by Cirronet, Inc. The Wizard runs under Windows 95/98/NT/2000/XP. This chapter provides the information you need to configure your network.

HopNet Configuration Wizard (5.0 or later)

If you haven't already installed the Wizard program, refer to the *Getting Started* section of this manual for instructions. Open the Wizard by double-clicking on the icon on the desktop. When the Wizard boots up, it will automatically detect the serial port to which the HopNet radio is connected and its baud rate. This process takes a few seconds to complete. During this process, the "Please wait" screen is displayed. Once the radio has been found and the Baudrate determined, the "Finished" screen is displayed. Click on the Continue button to enter the Wizard.

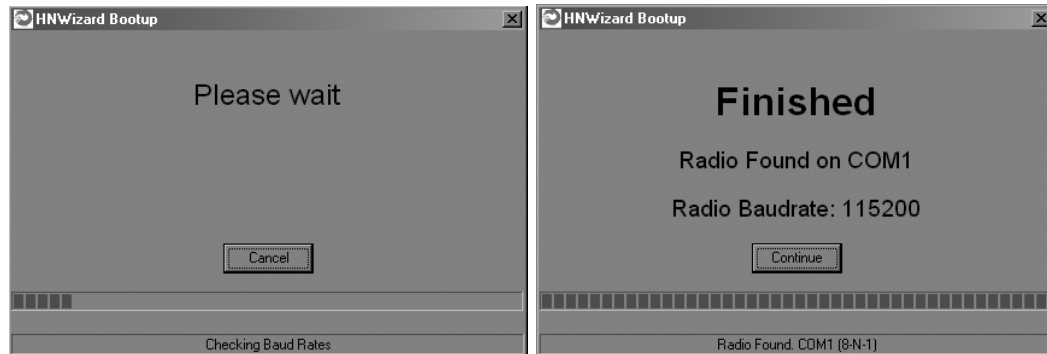

NOTE: The HopNet configuration Wizard is used with a variety of Cirronet radios. Not all radios support all the functions and features of every Cirronet radio. Thus, some selections in the Wizard will be grayed out if they are not applicable to the radio in use.

After detecting the serial port and baud rate of the HopNet radio, the Wizard reads the settings of the HopNet radio that is connected to the PC and will display them in the various parameter windows. In the bottom left corner of the Wizard window, the Base/Remote status, the serial number and the communication port are always displayed.

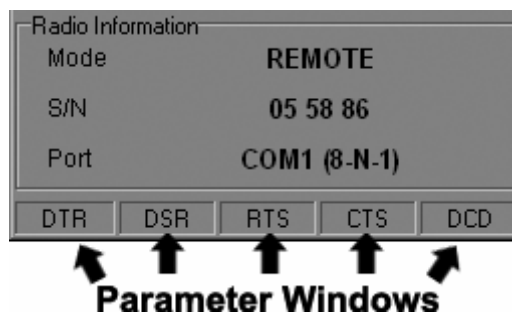

NOTE: The S/N displayed in the bottom left corner is the serial number of the radio inside the unit and is different from the serial number of the HopNet unit. Both the HopNet unit serial number and the radio serial number are on the radio unit of the HopNet product. The Wizard will also prompt to save the configuration settings to a file.

When a parameter value is changed from the value currently in the HopNet radio, the parameter label and value will turn red and the Apply Settings button will appear. When the value is changed back to the value that is currently in the attached HopNet radio, the label and parameter value will return back to black. When new values are applied to the HopNet radio, the red values will turn black indicating the updated values in the radio.

NOTE: The changes are not sent to the HopNet radio until the Apply Settings button is clicked.

Context sensitive help is available through the F1 key or Help menu.

About the INIT.INI File

One of the files unpacked with the program is the INIT.INI file. It contains the entries below and an explanation has been included on how each parameter may be used.

ErrorLevel=0

Leave this value as is. Only change it at the request of Cirronet Tech Support.

BiDirectionalHigh=55

BiDirectionalMedium=40

ReceiveHigh=55

ReceiveMedium=40

These parameters change the color levels (in percent) on the RF Tools bar graphs/pie charts.

RFToolsInterval=1000

This parameter sets the how often bar graphs / pie charts will update (in msec)

RSSIMarginal=-60

RSSIPoor=-80

These parameters set the levels (in dBm) of color the bars on the RSSI bar chart will display. Above the level set by **RSSIMarginal**, the bars will be green in color. Between the levels set by **RSSIMarginal** and **RSSIPoor**, the bars will be yellow in color and below the level set by **RSSIPoor**, the bars will be red in color.

FullShow=0, 1, 2

This changes the number of options that are viewable

0 (default) = Shows minimum amount of options.

1 = Adds all other options.

2 = Adds WinCom.

AutoDetect=1

1 = Auto-detects radio,

0 = User-defined inputs

The parameters below should not be changed as they are specific to different radios. These parameters will come from the factory set for your radio.

-40dBm=125

-95dBm=55

When the Wizard program is opened, it reads the parameters of the HopNet radio connected to the PC. These initial parameters are stored by the Wizard until the program is closed. This function allows the initial parameters to be loaded into any HopNet radio that is connected to the PC. Clicking on the Recover button displays the settings stored when the Wizard was first opened but will not load them in the radio until the Apply Settings is clicked. When the Apply Settings button is clicked, all the changed values will be loaded into the radio, even if the changed values are not on the tab currently displayed.

Parameters Tab

The Wizard program opens the main screen with the Parameters Tab displayed. The parameters screen of the Wizard allows the following variables to be set;

1. Base or Remote
2. Point-to-Point or Multipoint
3. Baud rate
4. Network number
5. Lockout Key
6. Roaming Mode
7. Protocol Mode

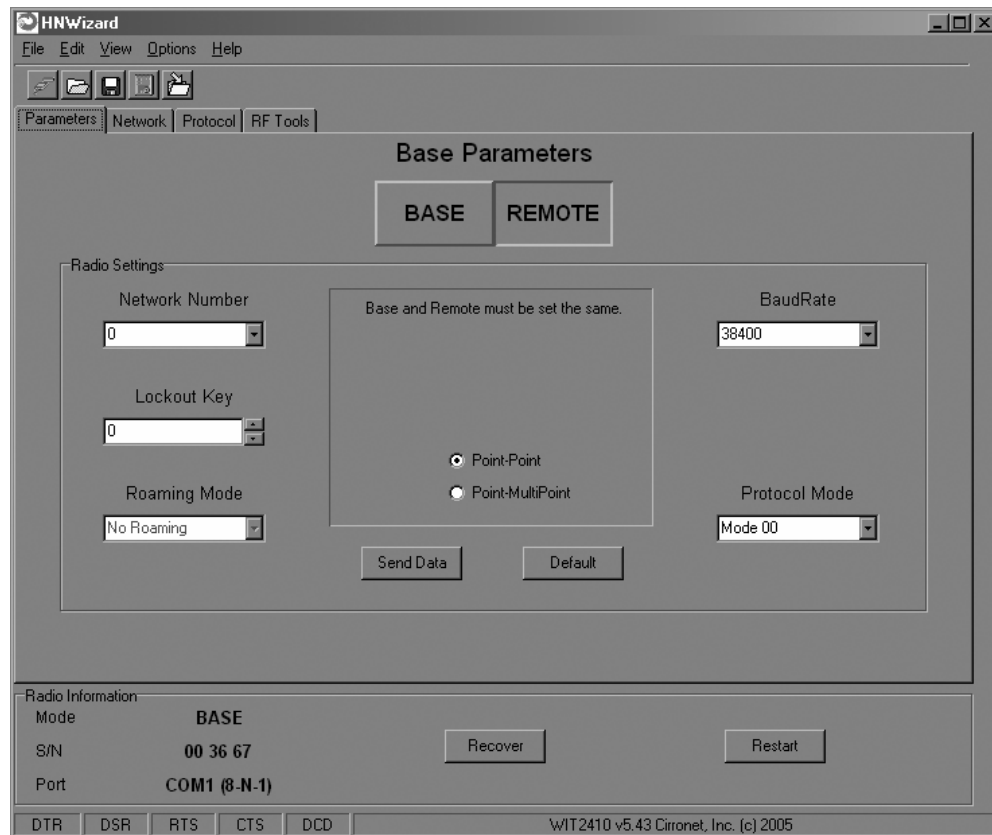

Depending on whether HopNet radio is configured as a Remote or Base when first connected, the heading on the Parameters page will display either “Remote Parameters” or “Base Parameters.” If the radio has a Modbus adapter, Transparent, Modbus and DNP3 selections will appear above the Point-Point-Multipoint selection as shown below.

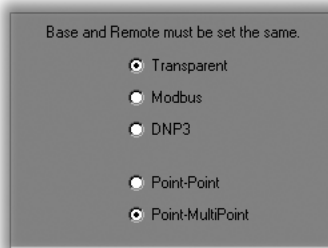

Modbus mode is selected to prevent Modbus errors from occurring due to inter-character gaps that are too long. Refer to the section, Modbus Operation for details on this mode.

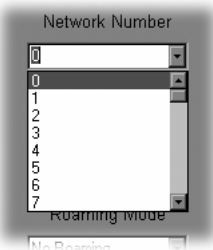

Network Number

This parameter is also known as Set Hopping and is the same command as `wn`. (Refer to “Configuration Commands” section for additional information on commands.) By using different network numbers or “hopping patterns”, nearby or co-located networks can avoid interfering with each other’s transmissions.

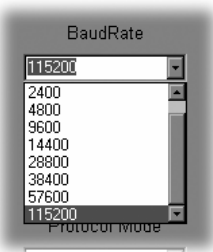

BaudRate

Also known as Set Data Rate Divisor (command `sd`) this parameter sets the serial bit rate between the modem and the host.



Lockout Key

This parameter is the same as **w1** and allows further network segregation beyond the network number. This feature allows multiple co-located networks in which global roaming is enabled. By using different lockout keys, the bases to which remotes link can be limited or segregated.

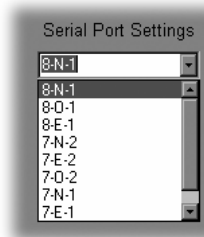

Serial Port Settings

This parameter is the same as **qs** and is only available on radios with Modbus adapters. It allows the setting of even, odd or no parity, 7 or 8 data bits and 1 or 2 stop bits.

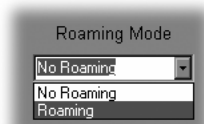

Roaming Mode

This parameter is the same as **wg** and allows remote radios to Roam or only link to specific base stations.

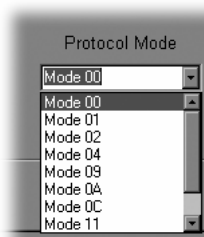

Protocol Mode

This parameter is the same as **sp** and enables the base station to operate in a multipoint network. Depending on the user application, more or less acknowledgment may be desired by the application. Remotes can operate in transparent mode even though the base station is operating in one of the nontransparent modes. When using a protocol mode, make sure to count in packet overhead when calculating network performance. Refer to the section on Protocol Modes for details on each format.

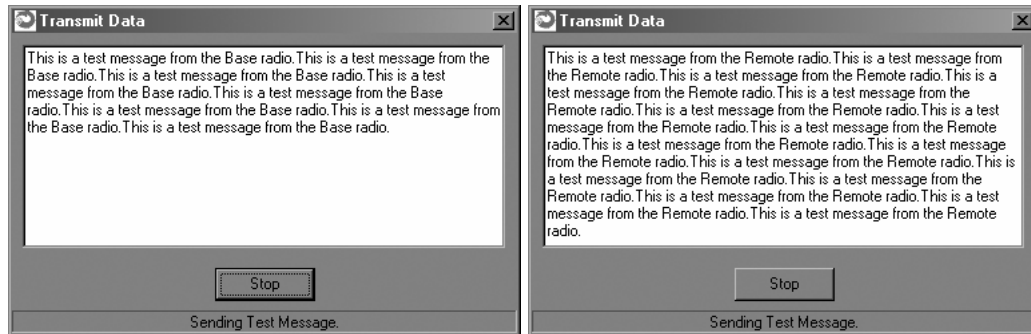

When the radio is linked to another radio, a communications test can be run by clicking on the Send Data button (shown below) on both radios. The remote radio's Transmit Data window (above left) will display the message, "This is a test message from the Base radio", which will repeat until the Stop button is pressed (on the base radio's HN Wizard main screen). The base radio's Transmit Data window (above right) will display the message, "This is a test message from the Remote radio" which will repeat until the Stop button is pressed (on the remote radio's HN Wizard main screen).

Send Data

The Send Data button (shown below) initiates the transmission of data.



Default

The Default button (shown above) returns all parameters to Factory settings.

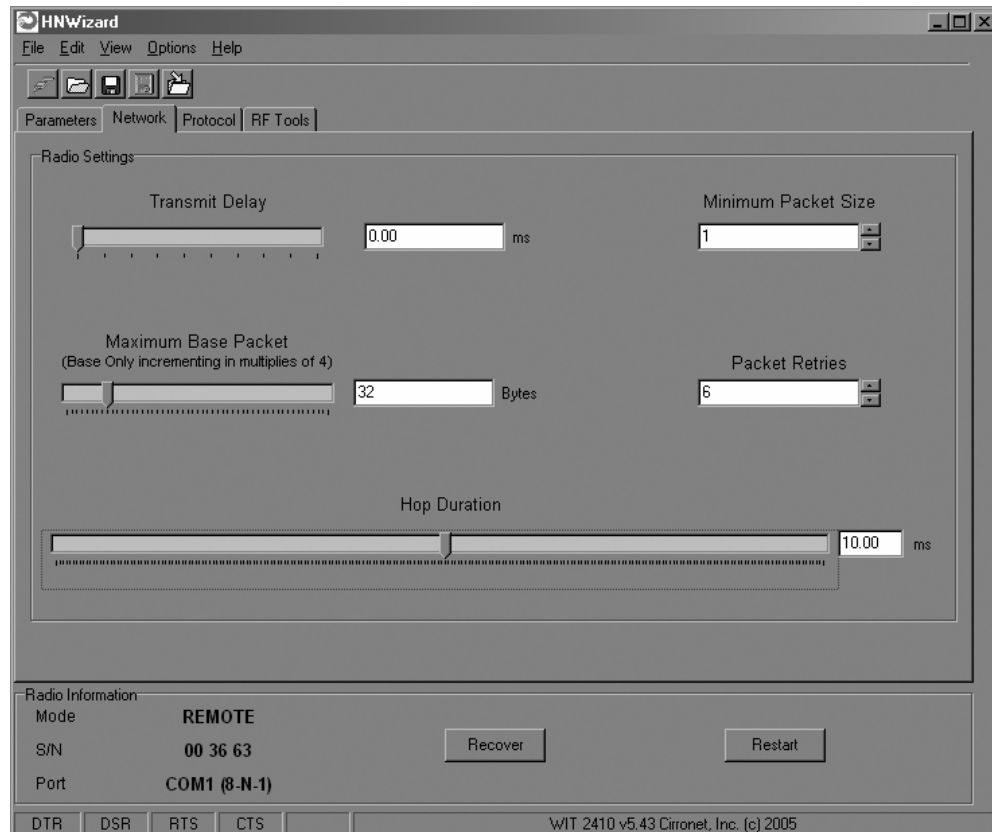

Network Tab Clicking on the Network tab will bring up a second configuration screen. From this screen it is possible to change the dwell time at which the HopNet radio hops, set a minimum number of bytes of data the radio must receive before it will transmit, set a maximum amount of time the radio will wait to receive the minimum number of bytes before transmitting what is in the radio's buffer and set the number of times the radio will repeat a transmission that is not acknowledged before discarding the data.



Set Data Transmit Delay

Essentially this is the `pt` command and when used in conjunction with the *minimum data length* parameter, sets the amount of time from the receipt of a first byte of data from the host until the radio will transmit in transparent mode. Default is `00H` which causes transmission to occur without any delay. When a host is sending a group of data that needs to be sent together, setting this parameter will provide time for the group of data to be sent by the host before the radio transmits. If the length of data to be sent together is longer than the time slot can send, the data will not be sent together but will be broken up over multiple hops. The length of time the radio will wait is equal to the specified value times the hop duration.

NOTE: The Transmit Delay is specified as a number of hop durations and thus will be an integer multiple of the Hop Duration. The Maximum Base Packet can only be set in radios set as a base. If the radio is a remote, this value cannot be changed.

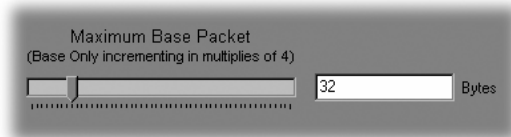

Maximum Base Packet (base station only)

This is the `pw` command and sets the amount of time allocated for transmission on each hop for the base station time slot in 4-byte increments. If using a protocol mode, attempting to send a packet with a length longer than this setting will cause the packet to be discarded.

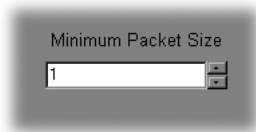

Set Minimum Data Length

This is the `pk` command and sets the minimum threshold number of bytes required to form a packet in transparent mode. The radio will wait until the data transmit delay elapses before sending a data packet with less than this number of bytes. This parameter can be used to keep short, intermittent transmissions contiguous. In packet modes, the length parameter in the data packet will override this value. This value is subject to the maximum data length even in packet mode.



Set Packet Retries

This is the `pr` command and if *ARQ Mode* is set to 0, it sets the number of times the radio will attempt to send an unsuccessful transmission before discarding it. If *ARQ Mode* is set to 1, it is the number of times every transmission will be sent, regardless of success or failure of a given attempt. When this parameter is set to 255, RF flow control mode is entered for transmissions from the radio. This mode can be entered for one or both radios in a point-to-point system. Using this mode in a point-to-multipoint system will stop transmissions to all radios when any one radio has a full buffer.

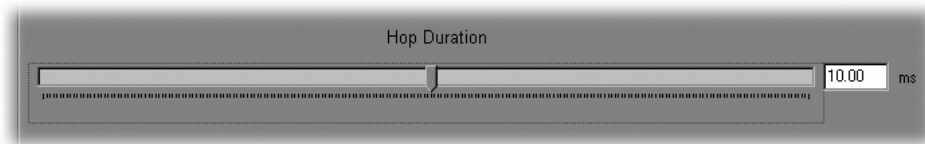

Set Hop Duration

This is the `ph` command and it sets the length of time the transceiver spends on each frequency channel. A smaller value will allow the remote to lock on to the base signal faster at system startup, and will generally decrease packet latency. A larger value increases network capacity, due to decreased overhead in channel switching. This Set Hop Duration value only needs to be set in the base which broadcasts the parameter to all remotes. However, link time can be reduced if this value is also programmed into the remotes, which use it as a starting value when scanning for the base.

The speed at which the radio hops affects both latency and throughput. The faster the radio hops, the shorter the latency but the lower the throughput. The minimum packet length and packet timeout allow fixed-length packets of data to be transmitted on a single hop without leaving data stuck in the radio's transmit buffer.



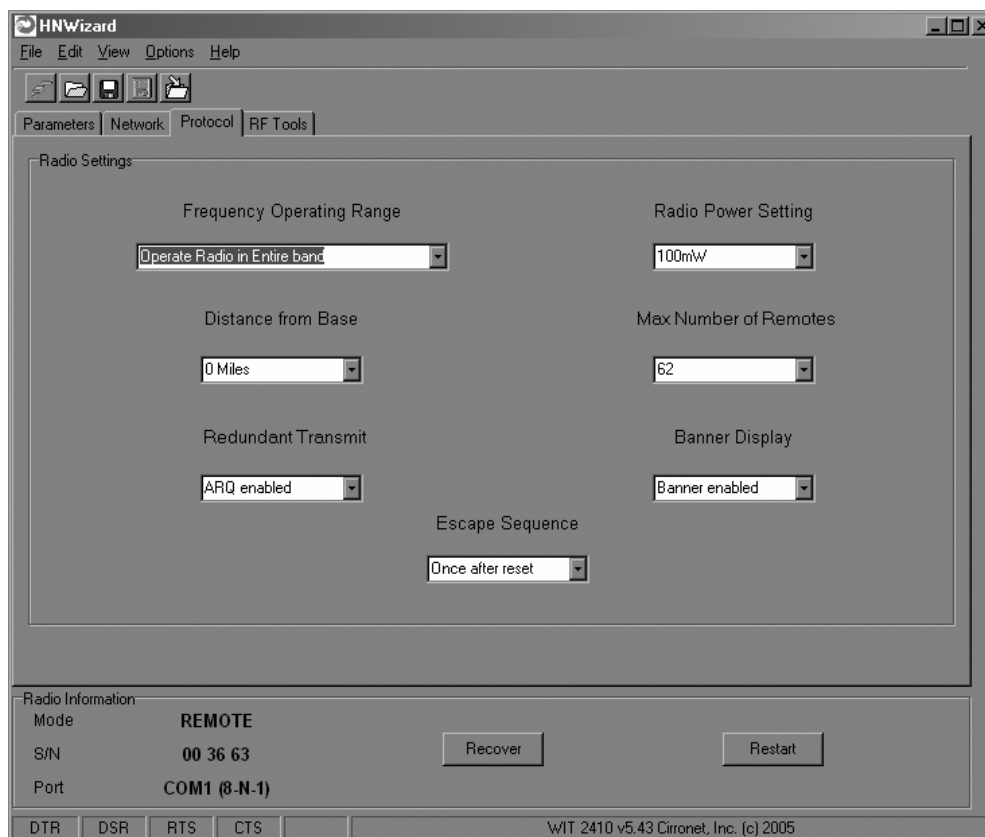

NOTE: If the hop speed is too fast, there may not be time to send a long packet on a single hop.

Refer to the *Protocol Commands* section of this manual for details on these commands.

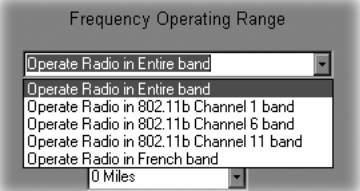
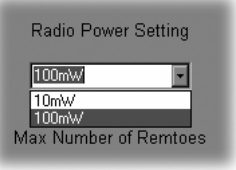

Protocol Tab

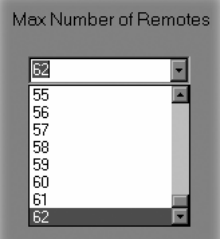
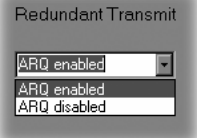
The Protocol tab brings up the configuration screen above. On the next page are descriptions of the commands/parameters that are available for modification.

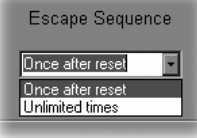
 <p>Set the Frequency Operating Range (pe) by clicking on the drop-down menu and making a selection. ¹</p>	 <p>Set Radio Power Setting (wp) up by clicking on a selection. ² <i>Note: This list will change depending on which radio is being used.</i></p>
 <p>Select the Distance from Base (dx) drop down and make a selection.</p>	 <p>Set Maximum Number of Remotes (pn) from 1 to 62.</p>
 <p>Set Redundant Transmit (px) by selecting either ARQ enabled or ARQ disabled.</p>	 <p>Choose to have the Banner Display (zb) or not by selecting Banner disabled or Banner enabled.</p>
 <p>Choose the type of Escape Sequence (zc) by selecting Once after reset or Unlimited times.</p>	

¹ The selections in this field will change depending on the frequency band the radio operates in. For 2.4GHz radios, selecting one of the 802.11b bands in which to operate, the HopNet radio can be used in locations with 802.11b networks without causing interference with those networks. If there are no 802.11b networks present, it is recommended that the radio be set to operate in the entire band which is the default. For 900MHz radios, there will only be two bands to select.

² The Radio Power Setting controls how much power is used to transmit data. Unless the HopNet radio operates in the 2.4GHz band and is being used in the European Union (EU) this setting should be left at the default High Power. Because of the built-in antenna of the HopNet radio, the 10mW power setting must be used when operating in an EU country.

RF Tools

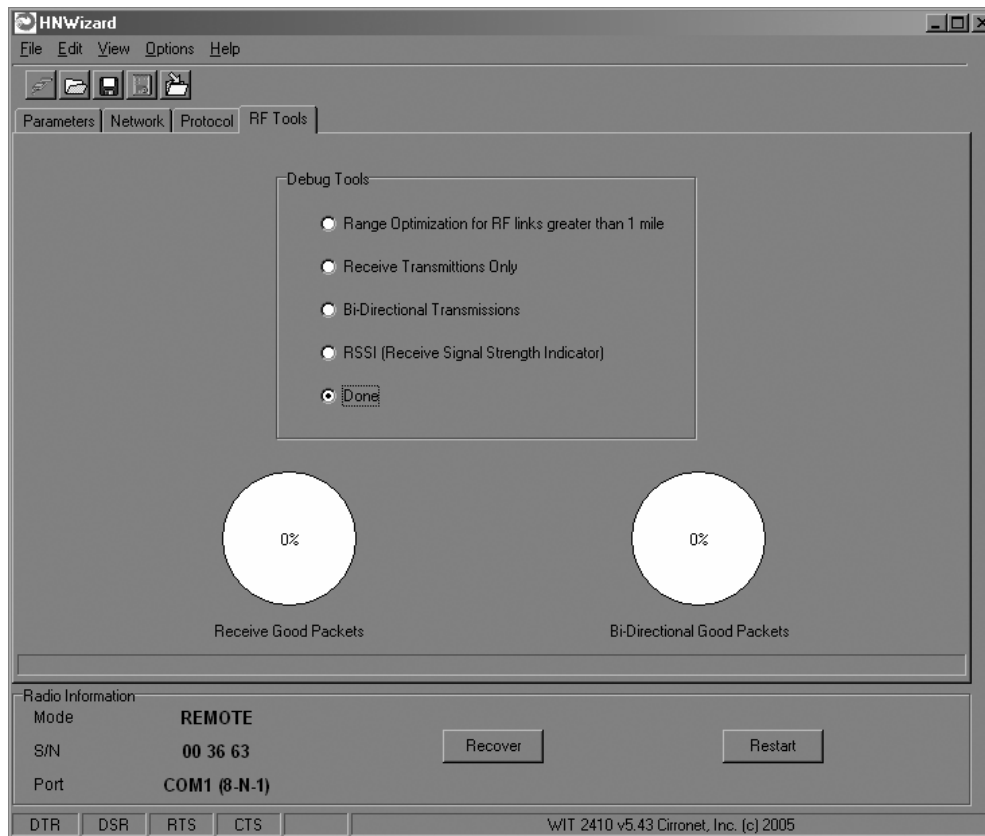

Clicking on the RF Tools tab brings up a screen that allows the receive signal strength to be monitored and the link quality to be observed. Range Optimization may be grayed out on certain radios.

NOTE: RF Tools only work on HopNet radios operating as remote radios. The radio must be linked with its base radio for the functions on this screen to work.

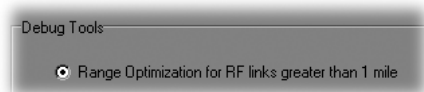

Range Optimization (HopNet 2410-based radios only)

This command automatically applies an adjustment factor to the over-the-air timing of remotes to compensate for the effects of propagation delay at long ranges. Simply click on the radio button opposite Range Optimization and the following screen will display.

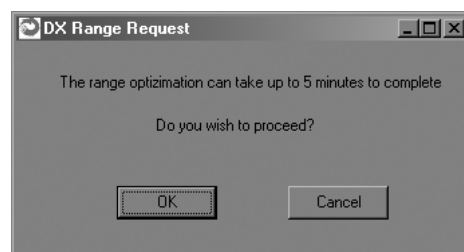

Click on OK and the Select Connect Range screen will appear.

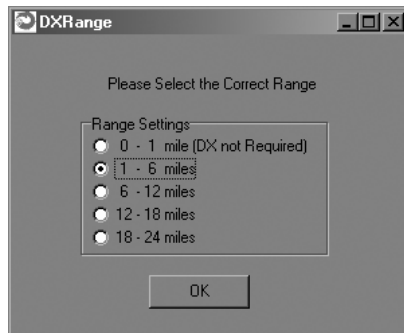

Click on the estimated distance between radios and click OK.

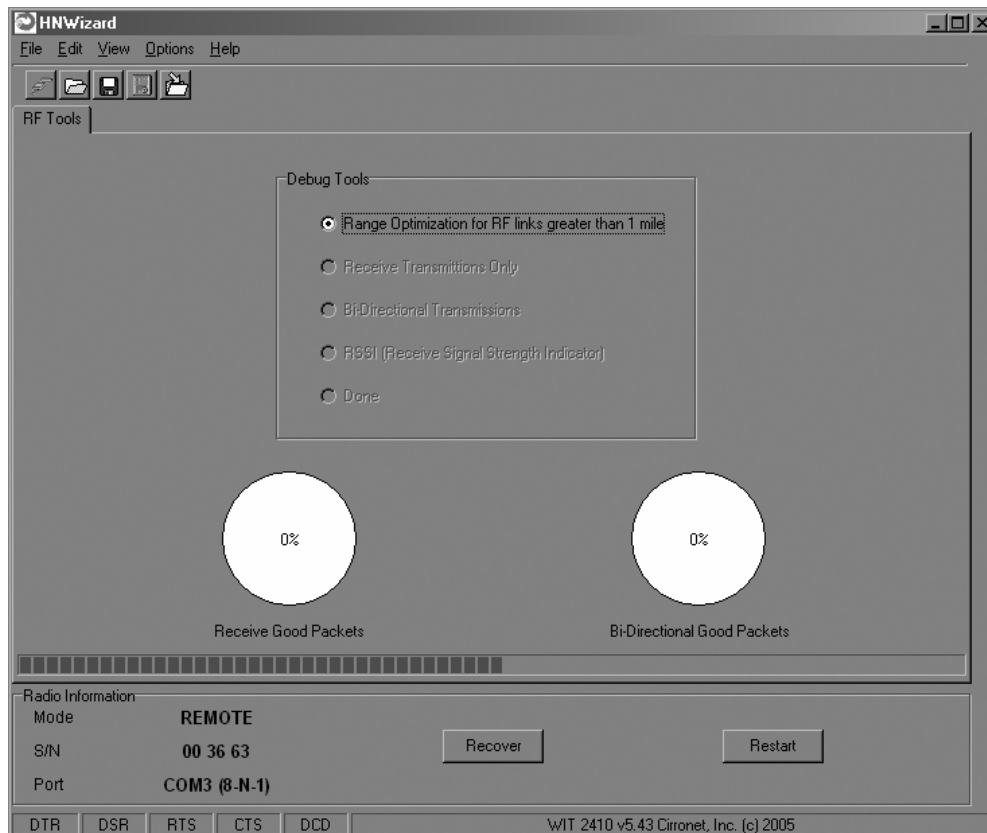

A bar will appear showing the progress of Range Optimization. Once the process has completed, the Range Optimization radio button will clear and the Done radio button will fill in indicating that adjustment factor has been applied.

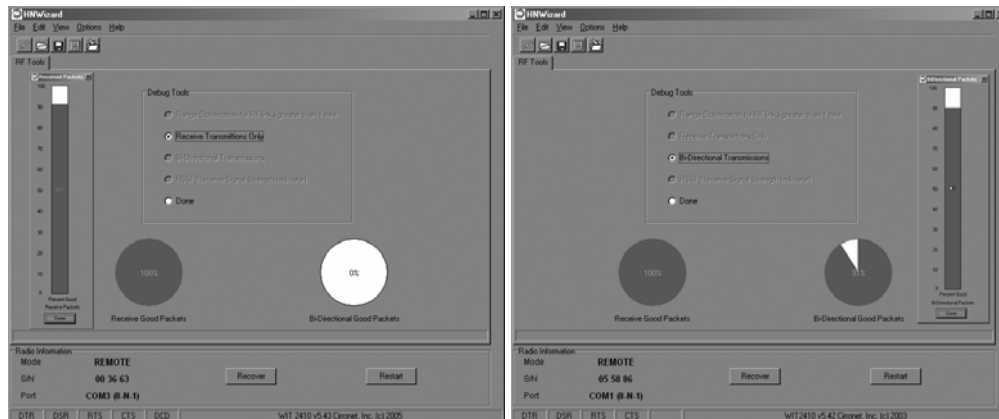

Receive and Bi-Directional Transmissions

The Receive Only function displays the percentage success rate for receiving transmissions from the base. This is an indication of how well the remote HopNet radio “hears” the base. The Bi-Directional function provides a round-trip success rate. That is, the base must successfully receive data from the remote and the remote must successfully receive data from the base. In theory, this percentage should be the square of the Receive Only percentage. If it is substantially less, it is an indication that the base HopNet radio is having difficulty “hearing” the remote. Good RF links will have the Receive Only percentage above 95% and the Bi-Directional percentage above 90%. These functions operate with the Automatic Retransmit Request (ARQ) disabled and as such provide an indication of link quality but do not provide an indication of how often data will get through since in normal operation ARQ is enabled and the radio automatically and transparently will resend data that was not received on the first attempt.

NOTE: The Options menu allows for bar graph display (in addition to the pie chart display) of the Receive Good Packets and Bi-Directional Good Packets data.

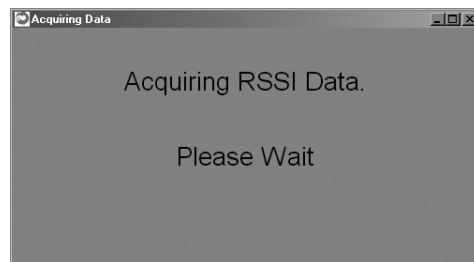

Received Signal Strength Indication.

This function will display on a channel basis, the strength of the signal received from the base by the remote. The values on the Y-axis are only approximate and should not be used as absolute reading values.

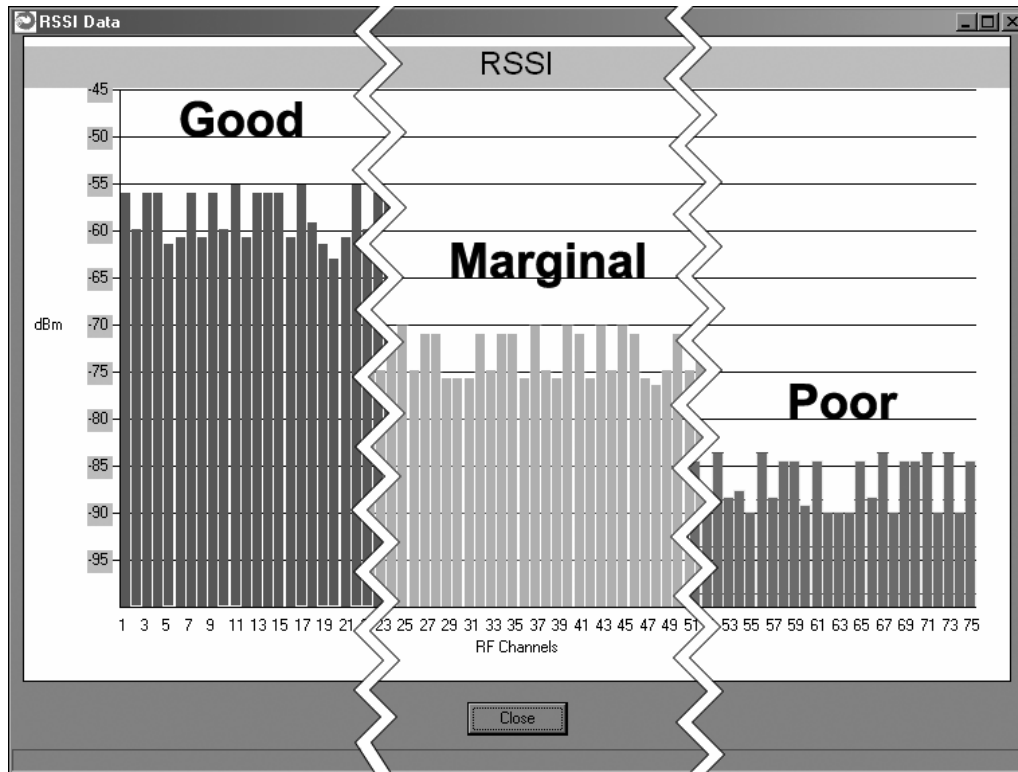

The bars will change color depending on the level of the signal received. The points at which they change color have been set in the .INI file, default setting for **RSSIMarginal** is -60 whereas the default setting for **RSSIPoor** is -80. Therefore any bars rising above the -60 level will display green. Conversely, any bars falling below -80 will display red. Bars at levels between these two points will display yellow. These points can be modified by editing the INIT.INI file.

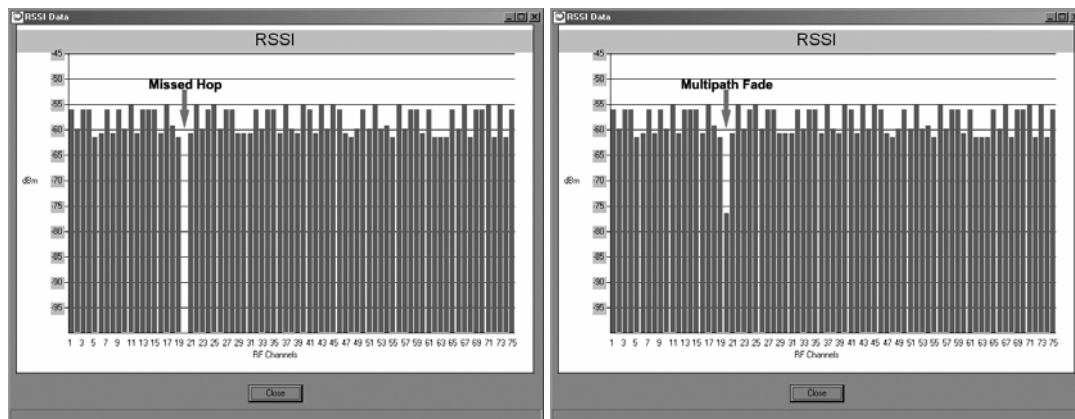

Under normal operation, the received signal strength for each channel will fluctuate, occasionally dropping to nothing indicating the hop was missed by the radio. This display also shows multipath fading when a channel drops noticeably below the surrounding channels. Over time, one can see clearly how different channels are affected to differing degrees.

WinCom Window

Normally, the WinCom Window is not displayed and no tab will appear to the right of the RF Tools tab. To display the WinCom tab, place the cursor in any hot field and press the CTRL+F10 key. Clicking on the WinCom tab will display the following screen.

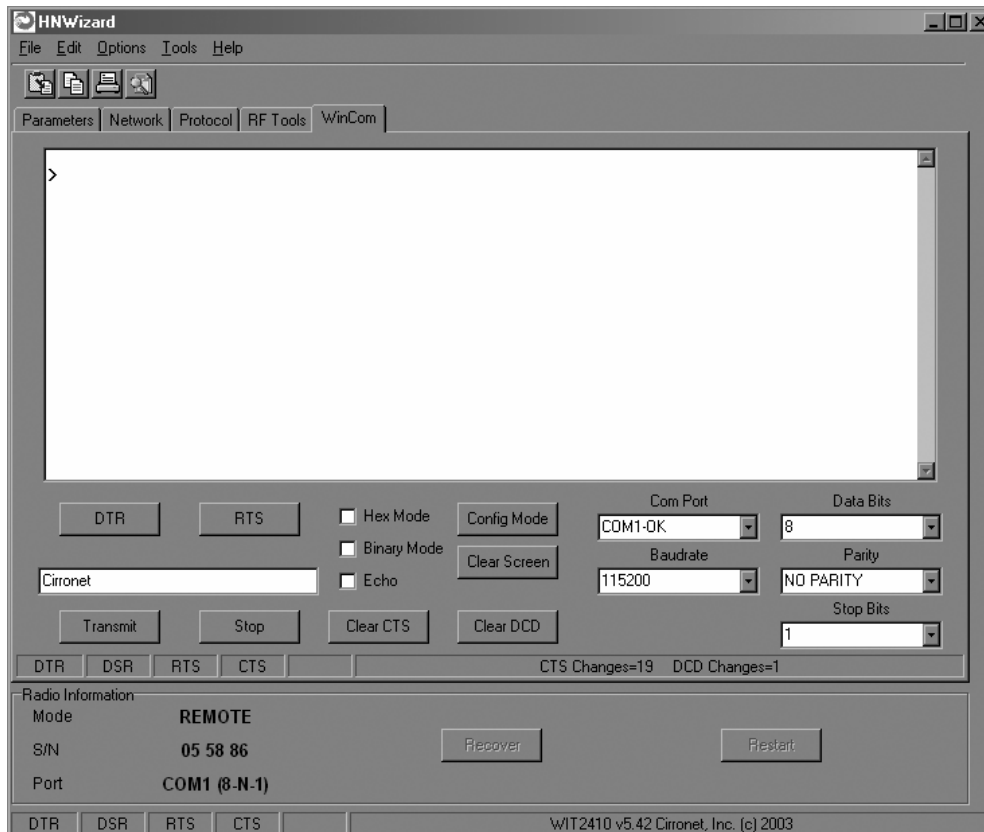

When first initialized, WinCom will automatically put the radio in Config Mode and two prompts will display as shown above. Both the Com Port and Baud Rate will have been automatically detected and set providing Auto-Detect is set in the INIT.INI file (default). If the INIT.INI file has been changed, Com Port and Baud Rate will need to be set manually.

NOTE: In order to display the banner, you will need to press the F1 key twice, toggling the DTR which resets the radio and causes a new banner to display. WinCOM de-asserts and re-asserts the DTR line to the radio which resets the radio causing the sign-on banner to be displayed as shown below.

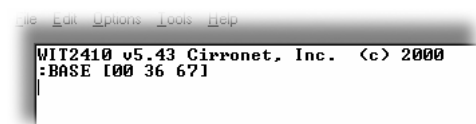

The banner indicates the radio firmware version, whether the radio is operating as a base or a remote and the unique factory serial number of the radio module. If nothing is displayed in the communications window of WinCOM, verify the COM port and baud rate settings, then reset the radio (by hitting F1 twice). Cycling power to the radio also will cause the sign on banner to be displayed.

NOTE: If the banner does not display, check the Banner Display Disable command (zb0) which may have been enabled.

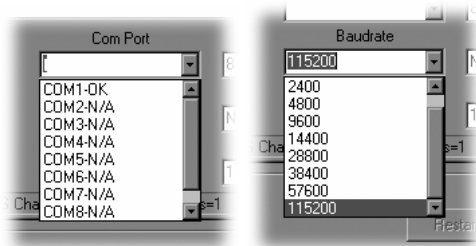

The COM port and baud rate can be changed using the drop down menus on the bottom right. All the available COM ports will be listed in the menu but will have OK or N/A designated. If another program that uses a COM port is open, that COM port will not be available for use by WinCOM.

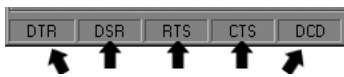

The boxes on the lower right of the WinCOM window provide the status of the COM port flow control being used to communicate with the radio. Note that DCD is only asserted by radios configured as remotes when they are linked to a base radio. Radios configured as bases always assert DCD even if no remotes are linked. Clicking on the DTR or RTS buttons will change the state of the respective signal line in the COM port.

The radio is normally in data mode – data that is sent to it from the PC is transmitted over the wireless connection. When the WinCOM window is active, keys typed on the keyboard will be sent to the radio and will be transmitted. Unless the “Echo” box is checked the typed data will not be displayed in the WinCOM window of the sending radio.

To change configuration parameters, the radio must be put into configuration mode by clicking on the Config Mode button on the WinCOM window immediately after opening WinCOM or after cycling power to the radio. Another method is to toggle the DTR by pressing the F1 key twice, which de-asserts then re-asserts DTR, then pressing the F3 key (or Config Mode button).

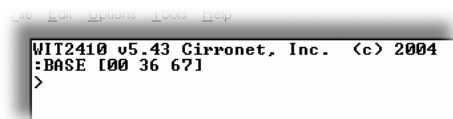

When the radio is in configuration mode, a “>” prompt character is displayed in the WinCom window as shown above. Configuration parameters are sent to the radio by entering them in the WinCom window after the “>” prompt and pressing the Enter key.

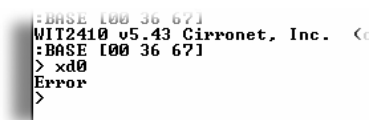

If an invalid command or value is entered, the radio will respond with “Error” as shown above. Until the command to save the parameters (**m>**) is issued, the new parameters will only be valid until power is cycled or DTR is toggled by pressing the F1 key twice.

New parameter values that have been issued are saved to non-volatile memory using the “**m>**” command. Refer to the *Memory Commands* section for details on this and other helpful memory commands.

To exit configuration mode from the WinCom screen, use the “**z>**” command and press Enter as shown below.

```

WIT2410 v5.43 Cirronet, Inc. <
-BASE [00 36 67]
> m0
> z>

```

The return to the data mode is indicated by an absence of the “>” prompt. Refer to the *Configuration Commands* section below for details on all the configurable parameters.

When the radio is linked to another radio, a communications test can be run by clicking on the Transmit button or pressing the F6 key. Whatever ASCII string is in the Transmit String window will be transmitted as shown below.

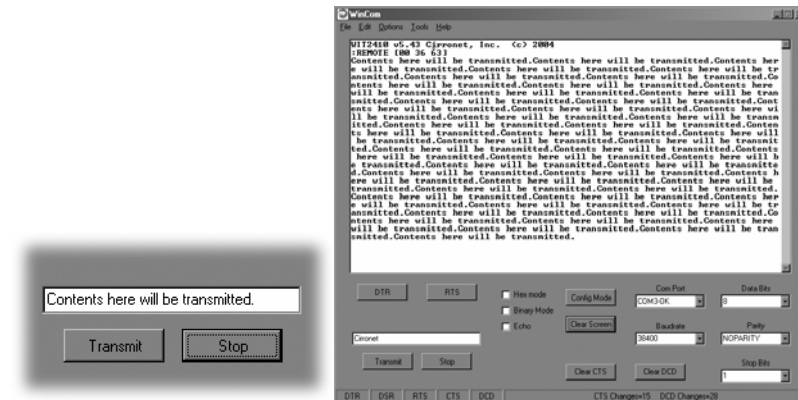

If the other radio is sending data, the received data will be displayed in the WinCOM window.

```

WIT2410 v5.43 Cirronet, Inc.
-REMOTE [00 36 63]
☐F<

```

If the Binary box is checked, all characters received will be displayed subject to the limitations of Windows. For example, a carriage return will not return the cursor to the left side of the window but the character corresponding to 0x0d value of the carriage return will be displayed. Similarly, if the Hex Mode box is checked, all characters are displayed in hexadecimal format.

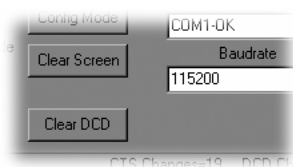

The Clear Screen button deletes all the text in the display window. The Clear CTS and Clear DCD buttons reset the respective changes counters to zero.

Function Keys

All of the function key shortcuts are described below:

F1	Toggles state of DTR (Sleep). State is shown in status line.
F2	Toggles state of RTS. State is shown in status line.
F3	Transmits “:wit2400”. Used to enter control mode.
F5	Toggles local echo. If you are transmitting characters through one modem to another modem, this allows you to see what you are typing.
F6	Toggles stream mode. Causes WinCOM to transmit a repeating pattern of characters. Useful for testing.
F8	Toggles binary mode. Displays extended ASCII and control characters. Useful for testing.
PgUp	Sets data rate of PC serial port to next higher value. Value is displayed in status line. Useful when WinCOM is used to change the interface data rate. WinCOM can communicate at new data rate without having to exit and re-enter WinCOM.
PgDn	Sets data rate of PC serial port to next lower value. Value is displayed in status line.

Recover

When the Wizard program is opened, it reads the parameters of the HopNet radio connected to the PC. These initial parameters are stored by the Wizard until the program is closed. This function allows the initial parameters to be loaded into any HopNet radio that is connected to the PC. Clicking on the Recover button displays the settings stored when the Wizard was first opened but will not load them in the radio until the Apply Settings is clicked. When the Apply Settings button is clicked, all the changed values will be loaded into the radio, even if the changed values are not on the tab currently displayed.

Restart

The Restart button on the Wizard causes the program to start the radio search and parameter load process again without shutting the program down. This is particularly useful when USB-to-RS-232 adapters are used that prevent the Wizard from detecting that a radio has been disconnected from the computer running the Wizard. If a radio is disconnected from the computer and the Wizard does not detect it, the Restart button should be clicked when it or another radio is connected. Note that clicking the Restart button will not change the parameter values stored for use by the Recover button.

Saving Configurations

Configuration settings that have been applied from the Wizard can be saved for future use. The Wizard prompts to save changes on initial boot-up, after changes have been applied and on exiting the Wizard if the changes have not previously been saved. The default filename for the configuration settings is “hn_XXXXXX.cfg” where XXXXXX is the serial number of the radio in the HopNet (This serial number is also on the outside of the radio). To save a configuration under another filename, simply enter the desired filename in the dialog box. Once a configuration has been saved, it can be used to set up additional HopNet radios with the same configuration by clicking on the Load command on the File menu. You will be prompted for a filename to load. Loading the file will load the parameters into the Wizard program but will not program the settings into the HopNet radio until the Apply Settings button is clicked.

Configuration Commands

The HN-210 has a wide selection of configuration parameters that can be modified using one or more of the configuration commands. The commands can be grouped into five categories based on what they do. The five sections are:

- Serial Interface Commands
- Network Commands
- Protocol Commands
- Status Commands
- Memory Commands

Each command is described in detail below. In the descriptions, brackets ([,]) are used to denote a set of optional arguments. Vertical slashes (/) separate selections. For example, given the string **wn[?|0..3f]**, some legal commands are **wn?**, **wn0**, **wn3** and **wna**. Most commands which set a parameter also have a **?** option which causes the modem to respond with the current parameter setting, e.g., **wn?** When using the WinCom window to enter these commands, the syntax must be followed as described. Each modem command must be followed by either a carriage return or a line feed. When these commands are entered from the main or advanced Wizard screen, the Wizard will insure the proper syntax is used.

Serial Commands

These commands affect the serial interface between the modem and the host. The default settings are 9600 bps and protocol mode 0.

Command	Description
sd[? 00..FF]	Set Data Rate Divisor Data Rate Divisor (hex) 1200 bps = BF 2400 bps = 5F 9600 bps = 17 14400 bps = 0F 19200 bps = 0B 28800 bps = 07 38400 bps = 05 57600 bps = 03 115200 bps = 01
sp[? 00..14]	Set Protocol Mode 00 = point-to-point transparent mode 01 = basic command and data only 02 = command, data and connection notification 04 = WIT2400 protocol mode 05 – 08 = <i>reserved for future use</i> 09 = mode 01 during transmit, transparent receive 0C = mode 04 during transmit, transparent receive 0D – 10 = <i>reserved for future use</i> 11 = transparent transmit, mode 01 during receive 12 = transparent transmit, mode 02 during receive 14 = transparent transmit, mode 04 during receive

Set Data Rate Divisor

Sets the serial bit rate between the modem and the host. This command takes effect immediately and will require adjusting the host serial rate to agree. Nonstandard rates may be programmed by entering a data rate divisor computed with the following formula:

$$\text{DIVISOR} = (230400/\text{RATE})-1$$

Round all non-integer values down.

Set Protocol Mode

Enables the base station to operate in a multipoint network. Depending on the user application, more or less acknowledgment may be desired by the application. Remotes can operate in transparent mode even though the base station is operating in one of the nontransparent modes.

When using a protocol mode, make sure to count in packet overhead when calculating network performance. Refer to the section on *Protocol Modes* for details on each format.

Network Commands

Network commands are used to set up a HopNet network and to set radio addressing and configuration.

Command	Description
wb[? 0 1]	Set Transceiver Mode 0 = remote (default) 1 = base station
wd[? 0-3f] (base only)	Set Default Handle Used to override automatic handle assignment by the base station 30 = default
wg[? 0 1] (remote only)	Enable Global Network Mode 0 = Link only to hop pattern specified by wn parameter (default) 1 = Link to any hop pattern, regardless of wn parameter
wn[? 0-3f]	Set Hopping Pattern (Network Number) 0 = default
wp[? 0 1]	Set Transmit Power 0 = 10mW 1 = 100mW (default)
wr? (remote only)	Read Receive Signal Strength
wu[? 0 1]	Set Point-to-Point Direct Mode 0 = Multipoint mode (default) 1 = Point-to-point direct mode
dx[? 0-FF] (remote only)	Set Range optimization 0 = default

Set Transceiver Mode

Sets modem operation as either base station or remote. Default is remote.

Set Default Handle

This handle will override the automatic handle assignment by the base station. When specified for the base, the default handle determines which remote it will address when transparent protocol mode is in effect. When 3FH is specified for the base, broadcast mode is entered.

Enable Global Network Mode

For networks with multiple base stations, remotes are ordinarily only able to link to one base station, set by the hopping pattern. Mode 1 enables the global mode that allows remotes to link to any base station they can hear, acquiring whatever hop pattern is required. In this mode a remote can only change base stations once it is no longer registered with a base station.

Set Hopping Pattern

The HopNet has 64 preprogrammed hopping patterns (also referred to as network numbers). By using different hopping patterns, nearby or co-located networks can avoid interfering with each other's transmissions. Even if both networks tried to use the same frequency, on the next hop they would be on different frequencies.

Set Transmit Power

The HopNet has two preset transmit power levels, 10mW (10dBm) and 100mW (20dBm). Control of the transmit power is provided through this command. Default is 100mW.

Read Receive Signal Strength Indicator (RSSI)

This command reports the relative signal strength averaged over the last 10 hops. This command returns a one byte value that is proportional to received signal strength and can range from **00H** to **FFH**. Typical values range from **30H** to **80H** where the lower the number the lower the received signal strength and the higher the number the higher the received signal strength. This is a relative indication and does not directly correspond to a field strength number. This is available only at the remotes as the base station is the only source that transmits on a regular basis. Plus, in a point-to-multipoint network the base will receive different signal strengths from each remote.

Set Point-to-Point Direct Mode

Sets point-to-point mode that is recommended for point-to-point applications, especially where the remote radio is mobile and may leave and re-enter the range of the base. This mode fixes the remote handle assignment to always be 30H and improves the re-registration process. Must be set in both base and remote radios.

Set Range Optimization

This command applies an adjustment factor to the over-the-air timing of remotes to compensate for the effects of propagation delay at long ranges. The default setting of **00H** is suitable for ranges of 0 to 0.8 miles (1287 m), with optimal performance at 0.1 miles (162m). Each increment of this parameter adds 0.1 miles (162 m) to the working range. Thus the optimal and max ranges are determined by:

$$\begin{aligned} \text{optimal} &= 0.1\text{mi} + 0.1\text{mi} \times \mathbf{dx} = 0.17\text{km} + 0.17\text{km} \times \mathbf{dx} \\ \text{max} &= 0.8\text{mi} + 0.1\text{mi} \times \mathbf{dx} = 1.33\text{km} + 0.17\text{km} \times \mathbf{dx} \end{aligned}$$

The following table presents various values of dx and the associated optimal and max ranges.

<i>dx</i> <i>setting</i>	<i>range:</i> <i>min</i>	<i>optimal</i>	<i>max</i>
00H	0mi/0km	0.1mi/0.2km	0.8mi/1.3km
01H	0mi/0km	0.2mi/0.3km	0.9mi/1.5km
04H	0mi/0km	0.5mi/0.8km	1.2 mi/2.0km
06H	0.1mi/0.2km	0.7mi/1.2km	1.4mi/2.3km
09H	0.4mi/0.7km	1.0mi/1.6km	1.8 mi/3.0km
13H	1.4mi/2.3km	2.0mi/3.3km	2.8mi/4.7km
31H	4.4mi/7.3km	5.0mi/8.3km	5.8 mi/9.7km
45H	6.4mi/10.7km	7.0mi/11.7km	7.8mi/13.0km
64H	9.4mi/15.7km	10.0mi/16.7km	10.8mi/18.0km
C8H	19.4mi/32.3km	20.0mi/33.3km	20.8mi/34.7km
FAH	24.4mi/40.7km	25.0mi/41.7km	25.8mi/43.0km

Optimal 'dx' setting for various distances.

Protocol Commands

These commands can be used to tune the transceiver for optimum transmission of data across the RF link. For most applications, the default values are adequate.

Command	Description
pe[? 0-8]	Set Alternative Frequency Band 0 = FCC/ETSI operation. (~2401 – 2471MHz) (default) 1 = France (~2448 – 2473MHz)/Avoids 11b channels 1 – 6 & 14 2 = Spain (~2448 – 2473MHz)/Avoids 11b channels 1 – 6 & 14 3 = Japan (~2473 – 2495MHz)/Avoids 11b channels 1 - 10 4 = Canada (~2452 – 2478MHz)/Avoids 11b channels 1 – 6 & 14 5 = Avoids 11b channels 6 – 14 6 = Avoids 11b channels 8 – 14 7 = Avoids 11b channels 1 & 10 – 14 8 = Avoids 11b channels 1,2 & 12 - 14
ph[? 00-fe] (base only)	Set Hop Duration 90H = default (=10ms)
pk[? 00-d0]	Set Minimum Data Length 01 = default
pl?	Get Maximum Data Length D4 = 212 bytes
pn[? 01-3e] (base only)	Set Maximum Number of Remotes 3e = default (=62 remotes)
pr[? 00-ff]	Set Packet Attempts Limit 10H = default FFH = Infinite retry (RF flow control point-to-point only)
pt[? 00-ff] (remote only)	Set Data Transmit Delay 00H = default
pv[? 0 1] base only)	Set Slot Assignment Mode 0 = default (dynamic slot assignment) 1 = static slot assignment
pw[? 00-34] base only)	Set Base Slot Size 08H = default (=32 bytes)
px[? 0 1]	Set ARQ mode. 0 = ARQ enabled (default) 1 = ARQ disabled (redundant transmission)

Note: Incorrect setting of these parameters may result in reduced throughput or loss of data packets.

Set Alternative Frequency Band

When set to 1, limits the operating RF channel set to the 2448 to 2473MHz frequency band for compliance with French regulatory standards. When set to 2, sets appropriate operation for Spain. When set to 3, sets appropriate operation for Japan. This setting should be set to 0, for FCC-compliant operation in the US (this is the default). For Canadian operation, set this parameter to 4.

Set Hop Duration

Sets the length of time the transceiver spends on each frequency channel. A smaller value will allow the remote to lock on to the base signal faster at system startup, and will generally decrease packet latency. A larger value increases network capacity, due to decreased overhead in channel switching. The hop duration is specified in 69.4 μ s increments. The default value of **90H** corresponds to a duration of 10ms. The maximum value of **FEH** is 17.627ms. For best results, do not specify a duration of less than 3 ms. This value only needs to be set in the base which broadcasts the parameter to all remotes. However, link time can be reduced if this value is also programmed into the remotes, which use it as a starting value when scanning for the base.

Set Minimum Data Length

This sets the minimum threshold number of bytes required to form a packet in transparent mode. The radio will wait until the data transmit delay elapses before sending a data packet with less than this number of bytes. Can be used to keep short, intermittent transmissions contiguous. In packet modes, the length parameter in the data packet will override this value (See Section 3.1). This value is subject to the maximum data length even in packet mode. See Get Maximum Data Length below.

Get Maximum Data Length (read only)

This parameter indicates the largest number of bytes that a remote will transmit per hop, based on the size of the slot it has been allocated by the base. In general more remotes mean less data can be transmitted per remote. By reading this parameter and dividing by the hop duration, the remote's data rate capacity can be determined. Attempting to send protocol mode packets longer than *maximum data length* will result in the packet being discarded without being sent. See Section 2.3.3 on the tradeoffs between *hop duration* and data length.

Set Maximum Number of Remotes (base only)

This parameter limits the number of remotes that can register with a given base. The default is 62 remotes which is the maximum number of remotes that can be registered with a base at one time. This command is useful when used in conjunction with global roaming for load balancing when base stations are collocated. It is also useful to assure a minimum remote throughput.

Set Packet Attempts Limit

If *ARQ Mode* is set to 0, sets the number of times the radio will attempt to send an unsuccessful transmission before discarding it. If *ARQ Mode* is set to 1, it is the number of times every transmission will be sent, regardless of success or failure of a given attempt. When this parameter is set to **FFH**, RF flow control mode is entered for transmissions from the radio (See Section 2.3.4). This mode can be entered for one or both radios in a point-to-point system. Using this mode in a point-to-multipoint system will stop transmissions to all radios when any one radio has a full buffer.

Set Data Transmit Delay

When used in conjunction with the *minimum data length* parameter, this sets the amount of time from the receipt of a first byte of data from the host until the radio will transmit in transparent mode. Default is 00H which causes transmission to occur without any delay. When a host is sending a group of data that needs to be sent together, setting this parameter will provide time for the group of data to be sent by the host before the radio transmits. If the length of data to be sent together is longer than the time slot can send, the data will not be sent together but will be broken up over multiple hops. The length of time the radio will wait is equal to the specified value times the hop duration.

Set Slot Assignment Mode (base station only)

Sets whether the base station will assign remote transmit slots dynamically, based on the number of remotes currently registered or whether the base station will assign remote transmit slots statically, based on the *maximum number of remotes* parameter. If static slot assignment is selected, make sure *maximum number of remotes* is correctly set. Otherwise remote transmit performance will suffer as transmit time will be reserved for remotes that may not exist. The dynamic assignment mode will generally be preferred; however, the static assignment mode will result in a static *maximum data length* parameter.

Set Base Slot Size (base station only)

Sets the amount of time allocated for transmission on each hop for the base station time slot in 69.4µs increments, corresponding to 4 bytes per unit. Maximum value is **34H** which corresponds to 208 bytes. If using a protocol mode, attempting to send a packet with a length longer than this setting will cause the packet to be discarded.

Set ARQ Mode

Sets ARQ mode when set to 0 which is the default. In this mode the radio will resend an unsuccessful transmission until either successful or *packet attempt limit* attempts have been made. When set to 1 selects redundant transmit mode that will send every transmission *packet attempt limit* times regardless of success or failure of any given attempt. When redundant transmit mode is used, receiving radios will discard all subsequent retransmissions once the transmission has been successfully received. Thus the receiving host will receive just one copy of the transmission.

Status Commands

These commands deal with general interface aspects of the operation of the HopNet.

Command	Description
zb[? 0 1]	Banner Display Disable 0 = disabled 1 = enabled (default)
zc[? 0..2]	Set Escape Sequence Mode 0 = disabled 1 = once after reset (default) 2 = unlimited times
zh?	Read factory serial number high byte.
zm?	Read factory serial number middle byte.
zl?	Read factory serial number low byte.
zp[? 0-5] base only)	Set the duty cycle at which the modem will wake up to send and receive data. Duty cycle equals $1/2^N$ where the argument of the command equals N.
zq[? 0 1] remote only)	Low Power Acquisition Mode Enable 0 = Disabled (default) 1 = Enabled
z>	Exit Modem Control Mode

Banner Display Disable

Enables or disables display of the banner string and revision code automatically at power-up. May be disabled to avoid being mistaken for data by the host.

Set Escape Sequence Mode

Enables or disables the ability to use the in-data-stream escape sequence method of accessing Control Mode by transmitting the string ":wit2410". When this mode is set to 1, the escape sequence only works immediately after reset (this is the default). When set to 2, the escape sequence may be used at any time in the data stream when preceded by a pause of 20 ms. For backwards compatibility with the WIT2400, the string ":wit2400" is also accepted for entering Control Mode. Note that the escape sequence must be interpreted as data by the radio until the last character is received, and as such will be transmitted to a receiving radio station.

Read Factory Serial Number High, Middle and Low Bytes.

These read only commands return one of the three bytes of the unique factory-set serial number, which are also visible in the startup banner.

Set Duty Cycle

Allows reduced power consumption by having a remote wake up only every 2^N hops to receive and transmit. Power consumption is roughly proportional to the duty cycle selected. For example, if $N=2$, the remote will wake up every fourth hop. Power consumption will be roughly $\frac{1}{4}$ the consumption as when $N=0$. This parameter must be set to the appropriate value when more than 16 remotes are in use.

Enable Low Power Acquisition Mode

When a remote is searching for a base to acquire and register with, it scans the frequency band very rapidly. This mode consumes about 80mA of current during this mode. To reduce the frequency consumption when a remote is in acquisition mode, a low power acquisition mode is provided. In this mode, the remote only scans the frequency band every other hop. This will reduce the average current consumption during acquisition to about 40mA. The tradeoff is it can take twice as long to acquire and register with a base, or up to 4 seconds.

Memory Commands

The user is able to store a configuration in nonvolatile memory, which is loaded during the initialization period every time the radio is powered up. Note that changes to the serial port baud rate- from recalling the factory defaults or recalling memory - will not take effect until DTR is toggled or power to the radio is cycled.

Command	Description
m0	Recall Factory Defaults
m<	Recall Memory
m>	Store Memory
m!	Display Modified Settings

Recall Factory Defaults

Resets the HopNet to its factory default state. This is useful for testing purposes or if there is a problem in operation of the system and the configuration is suspect. Use the *Store Memory* command afterwards if you wish the factory default settings to be remembered the next time you cycle power or reset the radio.

Recall Memory

Useful for restoring the power-on settings after experimenting with temporary changes to data rate, protocol or network parameters, etc.

Store Memory

This command is necessary after any command to change the data rate, transceiver address, or other radio setting that you wish to make permanent.

Display Modified Settings

This command lists all parameter settings that are different from the factory default settings. This will list changed parameters whether or not they have been stored with the m> command. Note that issuing this command will cause the radio to lose link with the base and will cause all remotes to lose link when issued to the base radio.

Modem Command Summary

Serial Commands

sd[? 00..ff]	Set Data Rate Divisor
sp[? 00..14]	Set Protocol Mode

Network Commands

wb[? 0 1]	Set Transceiver Mode
wd[? 0..3f]	Set Default Handle (base only)
wn[? 00..3f]	Set Hopping Pattern
wg[? 0 1]	Enable Global Network Modes (remote only)
wp[? 0 1]	Set Transmit Power
wr?	Read Receive Signal Strength (remote only)
wu[? 0 1]	Set Point-to-Point Direct Mode
dx[? 0..ff]	Set Range Optimization (remote only)

Protocol Commands

pe[? 0..8]	Set Alternative Frequency Band
ph[? 00..fe]	Set Hop Duration (base only)
pl?	Get Maximum Data Length
pn[? 01..3e]	Set Maximum Number of Remotes (base only)
pk[? 00..d4]	Set Minimum Data Length
pr[? 00..ff]	Set Packet Attempts Limit
pt[? 00..ff]	Set Data Transmit Delay (remote only)
pv[? 0 1]	Set Slot Assignment Mode (base only)
pw[? 00..34]	Set Base Slot Size (base only)
px[? 0 1]	Set ARQ Mode

Status Commands

zb[? 0 1]	Banner Display Disable
zc[? 0..2]	Set Escape Sequence Mode
zh?	Read Factory Serial Number High Byte
zm?	Read Factory Serial Number Middle Byte
zl?	Read Factory Serial Number Low Byte
zp[? 0..4]	Set Duty Cycle(base only)
zq[? 0 1]	Enable Low Power Acquisition (remote only)
z>	Exit Modem Control Mode

Memory Commands

m0	Recall Factory Defaults
m<	Recall Memory
m>	Store Memory
m!	Display Modified Settings

Troubleshooting

Overview

Introduction

Troubleshooting the HopNet products is not difficult, but it does require a logical approach. It is best to begin troubleshooting at the base station because the rest of the system synchronizes to it. If the base station has problems, the entire network will be compromised.

This chapter provides troubleshooting information for your HopNet products.

Transceiver Requirements

For proper operation, all transceivers in the network must meet these basic requirements:

- Adequate and stable power

- Secure connections (Power, RF, and Data)

- Proper programming especially Hop Duration and Network Address

Common System Problems

The following table offers suggestions for resolving some common system problems that the operator may experience from the radio system. If problems persist, contact the factory for further assistance.

Problem	System Checks
Unit is inoperative	<ol style="list-style-type: none"> 1. Check for proper DC voltage at the power connector. 2. Momentarily remove and reapply power.
No Carrier Detect at remote units or intermittent	<ol style="list-style-type: none"> 1. Check for secure interface connections at the transceiver. 2. Check antenna, feedline, connectors, and reflective power. 3. If remote unit is in synchronization but performance is poor, it may indicate antenna problems. Check for properly aligned antenna headings. 4. Verify proper programming of the system parameters.
Interference is suspected	<ol style="list-style-type: none"> 1. Verify that the system has a unique network address. Nearby systems with same address will cause interference problems. 2. If Omni-directional antennas are used with the remote units, consider using a directional type instead. This will often limit interference to and from other stations. 3. Check RSSI value at the remote. A low value would correspond to a weak signal strength.

Guidelines for Reducing Interference

Introduction

The transceivers share the same frequency spectrum with other services and other Part 15 devices in the US. Because of this, you may not achieve 100 percent error free communications in a given location. You should also expect some level of interference. However, the flexible design of the radio and the hopping pattern should allow for adequate performance as long as care is taken in choosing station location, configuration parameters of the transceivers, and protocols techniques.

Use the following guidelines to reduce interference in your HopNet system.

Guidelines for Setting Up the Network

In general, the following points should be followed when setting up a network:

Systems installed in rural areas are least likely to encounter interference.

If possible, use directional antennas at remote sites. The directional antennas confine the transmission path and reception pattern to a comparatively narrow lobe, which minimizes interference from stations located outside the pattern.

Multiple HopNet systems can co-exist in close proximity to each other with very minor interface as long as they are assigned a unique network address. Each network address has a different hop pattern.

If interference is suspected from a similar operating system, change the antenna polarization. This will provide an additional 20dB of attenuation to interference.

For indoor applications, set all transceivers for the lowest level necessary for reliable communications. This lessens the chance of interference from nearby systems.

Guidelines for Selecting Your Site

Use these guidelines to select a proper site for the master remote stations. Suitable sites must provide the following:

An adequate and stable source of primary power.

Antenna location that provides an unobstructed transmission path in the direction of the associated units.

Proper antenna selection, data access, and feedline cabling

A clear line-of-sight. Microwave radio signals travel primarily by line-of-sight, and obstructions between the sending and receiving stations will affect system performance.

Guidelines for Avoiding Terrain Obstructions

The HopNet transceivers operate in the 2.4 GHz frequency band. While this band offers many advantages over the VHF band for data transmission, it is also more prone to signal attenuation from obstructions such as terrain, foliage, buildings and anything else in the transmission path.

Use the following guidelines to avoid terrain obstructions:

A line-of-sight transmission path between the base and the associated remote sites provides for the most reliable transmission path.

A line-of-sight path can be achieved by mounting the station antenna on a tower or elevated structure that raises it to a sufficient level to clear surrounding terrain and other obstructions.

The importance of a clear transmission path relates closely to the distance to be covered. If the system is to cover only a limited geographical area such as 1-3 miles, then some obstructions may be tolerated with minimal impact.

For longer-range systems, any substantial obstruction in the transmission path could compromise the performance of the system.

Customer Support

Introduction

Cirronet, Inc. products are designed for long life and trouble free operation. The following information is provided if servicing becomes necessary.

Technical Assistance

Technical assistance for Cirronet products is available during the hours of 9:00 A.M – 5:30 P.M. Eastern Standard Time. When calling, please have available the complete model name, serial number, and a complete description of the problem. Most problems can be resolved without returning the unit to the factory.

The following telephone numbers are available for assistance.

Phone	678-684-2000
Fax	678-684-2001

Factory Repairs

If return of equipment is necessary, you will be issued a Return Material Authorization number (RMA #). The RMA # will help expedite the repair so that equipment can be returned as quickly as possible. Please be sure to include the RMA number (#) on the outside of the shipping box and on any correspondence relating to the repair. Any equipment returned without an RMA # may be delayed in the repair cycle.

Please be sure to carefully package all items to be returned and address to:

CIRRONET, INC.
5375 Oakbrook Parkway
Norcross, GA 30093

RMA # ***

Technical Specifications

Refer to the tables below for the technical specifications for the HN-210 Remotes.

Electrical

Specification	Value
Transmitter FCC ID	HSW-2410M
Transmit Power	EIRP: +24 dBm Nominal (HN-210) +18 dBm (HN-210X)
Hopping Patterns	User configurable, 64 patterns (networks) available
Number of Channels	75 US; 25 France, Spain & Japan
Line-of-Sight Range	Greater than 3.5 miles (up to 20 miles with HN-210x and appropriate antennas)
Frequency Band	2401-2475 MHz (USA) 2448-2478 MHz (France) 2448-2473 MHz (Spain) 2473-2495 MHz (Japan)
Approvals	US FCC: Part 15. 203 Industry Canada European Community: ETS 300.328 Compliance
Receiver Sensitivity	-93 dBm (HN-210 Integrated patch antenna adds 6 dB to the link budget and -99dBm sensitivity)
Data Interface	RS-232
Input Power at Connector	9 VDC Operating 160 mA Typical (750 mA surge)

Mechanical

Specification	Value
Case	NEMA 4X, IP 66
Size	5.1 in. x 3.1 in. x 1.4 in. 130mm x 80mm x 35mm
Weight	1.75 lb (including cable) 794 g
Data Connector	DB-9 Female
Interconnect Cable Connector	RJ-45

Environmental

Specification	Value
Temperature Range	-30 to +70 degrees C
Humidity	95% at +40 degrees C, Non-condensing

Glossary of Terms

Refer to the following list of terms that may be unfamiliar to you. These terms are used throughout this document.

Term	Definition
ARQ	Automatic Repeat Request. The operation in which the radio will re-send the data until it is received correctly.
bps	Bits-per-second. A measure of information transfer rate of digital data across a channel.
Decibel	A measure of the ratio between two signal levels. Used to express either loss or gain.
dBi	Decibels referenced to an ideal isotropic radiator in free space. Used to express antenna gain.
dBm	Decibels referenced to 1 milliwatt. An absolute unit used to measure signal power. Transmitter power output or received signal strength.
DCE	Data Communications Equipment. A device that receives data in the form of digital signals at its input. The modem side of a computer-to-modem connection.
DCD	Data Carrier Detect.
DTE	Data Terminal Equipment. A device that provides data in the form of digital signals at its output. The computer side of a computer-to-modem connection.
EIRP	Effective Isotropic Radiated Power.
ISM	Industrial, Scientific, or Medical band operating at 2.4 GHz. Allows use of a radio without a license, but the equipment must be immune to interference from other users in the band and approved for use in the intended country.
Latency	The delay between when data is received on TX until it is output on RX.
RMA	Return Material Authorization.
RTU	Remote Terminal Unit. A device used in data collection.
TDMA	Time Division Multi Access. A time slot multiplexing protocol for multinode networking.

Warranty

Seller warrants solely to Buyer that the goods delivered hereunder shall be free from defects in materials and workmanship, when given normal, proper and intended usage, for twelve (12) months from the date of delivery to Buyer. Seller agrees to repair or replace at its option and without cost to Buyer all defective goods sold hereunder, provided that Buyer has given Seller written notice of such warranty claim within such warranty period. All goods returned to Seller for repair or replacement must be sent freight prepaid to Seller's plant, provided that Buyer first obtain from Seller a Return Goods Authorization before any such return. Seller shall have no obligation to make repairs or replacements which are required by normal wear and tear, or which result, in whole or in part, from catastrophe, fault or negligence of Buyer, or from improper or unauthorized use of the goods, or use of the goods in a manner for which they are not designed, or by causes external to the goods such as, but not limited to, power failure. No suit or action shall be brought against Seller more than twelve (12) months after the related cause of action has occurred. Buyer has not relied and shall not rely on any oral representation regarding the goods sold hereunder, and any oral representation shall not bind Seller and shall not be a part of any warranty.

THE PROVISIONS OF THE FOREGOING WARRANTY ARE IN LIEU OF ANY OTHER WARRANTY, WHETHER EXPRESS OR IMPLIED, WRITTEN OR ORAL (INCLUDING ANY WARRANTY OR MERCHANT ABILITY OR FITNESS FOR A PARTICULAR PURPOSE). SELLER'S LIABILITY ARISING OUT OF THE MANUFACTURE, SALE OR SUPPLYING OF THE GOODS OR THEIR USE OR DISPOSITION, WHETHER BASED UPON WARRANTY, CONTRACT, TORT OR OTHERWISE, SHALL NOT EXCEED THE ACTUAL PURCHASE PRICE PAID BY BUYER FOR THE GOODS. IN NO EVENT SHALL SELLER BE LIABLE TO BUYER OR ANY OTHER PERSON OR ENTITY FOR SPECIAL, INCIDENTAL OR CONSEQUENTIAL DAMAGES, INCLUDING, BUT NOT LIMITED TO, LOSS OF PROFITS, LOSS OF DATA OR LOSS OF USE DAMAGES ARISING OUT OF THE MANUFACTURE, SALE OR SUPPLYING OF THE GOODS. THE FOREGOING WARRANTY EXTENDS TO BUYER ONLY AND SHALL NOT BE APPLICABLE TO ANY OTHER PERSON OR ENTITY INCLUDING, WITHOUT LIMITATION, CUSTOMERS OF BUYERS