



Features

- Low leakage current: 1 nA
- Bidirectional configuration
- ESD protection 30 kV max.
- Low capacitance: 3 pF typ.
- Replaces 0805 MLV devices
- RoHS compliant* and halogen free**
- Automotive grade AEC-Q101 compliant product***

Applications

- Automotive
 - Entertainment applications
 - Comfort applications
- Communication lines
- Portable electronics

CDSOD323-T24C-DSLQ - TVS Diode Series

General Information

Portable communications and telecom equipment manufacturers are challenging the semiconductor industry to develop increasingly smaller electronic components for high-speed communication rates.

Bourns offers Transient Voltage Suppressor Diodes for surge and ESD protection applications in SOD323 package size format. Bourns® Chip Diodes conform to JEDEC standards, are easy to handle on standard pick and place equipment and their flat configuration minimizes roll away.

The Bourns® device will assist compliance with IEC 61000-4-2 (ESD), IEC 61000-4-4 (EFT) and IEC 61000-4-5 (Surge) requirements.

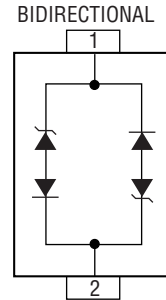

Absolute Maximum Ratings (@ T_A = 25 °C Unless Otherwise Noted)

Parameter	Symbol	CDSOD323-T24C-DSLQ	Unit
Peak Pulse Current (t _p = 8/20 μs)	I _{PPM}	6	A
Operating Temperature	T _J	-55 to +150	°C
Storage Temperature	T _{STG}	-55 to +150	°C
ESD Protection (per IEC 61000-4-2) Contact Discharge	ESD	±30	kV

Electrical & Thermal Characteristics (@ T_A = 25 °C Unless Otherwise Noted)

Parameter	Symbol	CDSOD323-T24C-DSLQ	Unit
Min. Breakdown Voltage @ 1 mA	V _{BR}	26.7	V
Working Peak Voltage	V _{WM}	24.0	V
Maximum Clamping Voltage @ I _P = 1 A	V _C	43.0	V
Typical Clamping Voltage @ 8/20 μs @ I _{PP}	V _C	56.0 V @ 6 A	V
Maximum Leakage Current @ V _{WM}	I _D	1	nA
Typical Capacitance @ 0 V, 1 MHz	C _J	3	pF

Note: The electrical specifications apply in both polarities.

* RoHS Directive 2002/95/EC Jan. 27, 2003 including annex and RoHS Recast 2011/65/EU June 8, 2011.

** Bourns considers a product to be "halogen free" if (a) the Bromine (Br) content is 900 ppm or less; (b) the Chlorine (Cl) content is 900 ppm or less; and (c) the total Bromine (Br) and Chlorine (Cl) content is 1500 ppm or less.

*** Q suffix for automotive and other applications requiring appropriate AEC-Q101 compliance for electronic limiters.

Specifications are subject to change without notice.

The device characteristics and parameters in this data sheet can and do vary in different applications and actual device performance may vary over time.

Users should verify actual device performance in their specific applications.

Performance Graphs

Typical Peak Pulse Power vs. Pulse Time

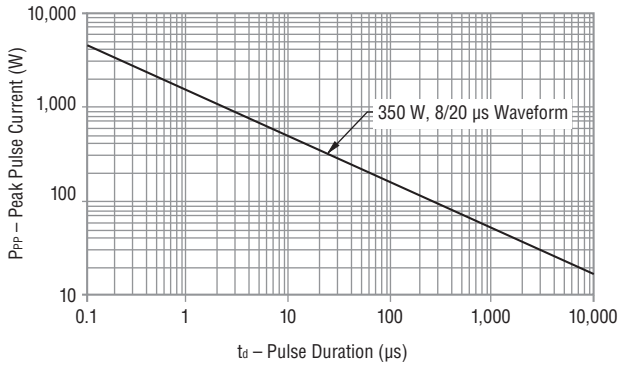

Pulse Waveform

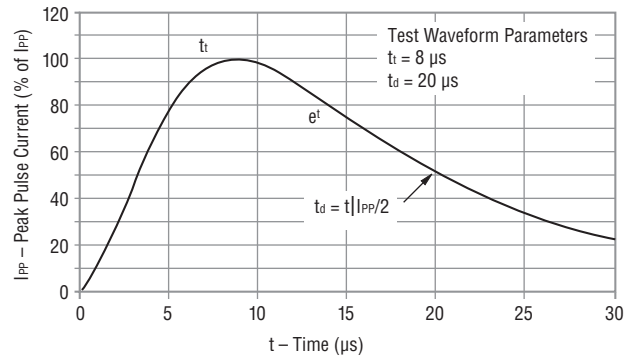

Block Diagram

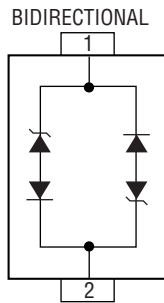

How to Order

CD SOD323 - T 24 C - DSL Q

Common Code _____
 Chip Diode _____
 Package _____
 • SOD323 = SOD-323 Package
 Model _____
 T = Transient Voltage Suppressor
 Working Peak Reverse Voltage _____
 24 = 24 V_{RWM} (Volts)
 Suffix _____
 C = Bidirectional Diode
 -DSL = Low Leakage Current
 Q = AEC-Q101 Compliant

Environmental Specifications

Moisture Sensitivity Level1
 ESD Classification (HBM)..... 3B

Specifications are subject to change without notice.
 The device characteristics and parameters in this data sheet can and do vary in different applications and actual device performance may vary over time.
 Users should verify actual device performance in their specific applications.

CDSOD323-T24C-DSLQ - TVS Diode Series



Product Dimensions

This is a molded JEDEC SOD-323 package with lead free 100 % Sn plating on the terminations. It weighs approximately 30 mg and has a flammability rating of UL 94V-0.

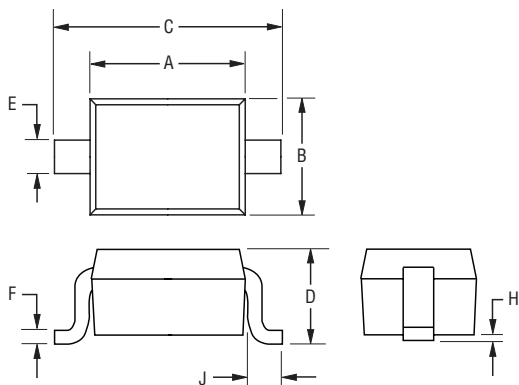

Dimensions	
A	$\frac{1.60 - 1.90}{(0.063 - 0.075)}$
B	$\frac{1.15 - 1.45}{(0.045 - 0.057)}$
C	$\frac{2.39 - 2.70}{(0.094 - 0.106)}$
D	$\frac{0.92 - 1.14}{(0.036 - 0.045)}$
E	$\frac{0.25 - 0.40}{(0.010 - 0.016)}$
F	$\frac{0.08 - 0.20}{(0.003 - 0.008)}$
H	$\frac{0 - 0.13}{(0.000 - 0.005)}$
J	$\frac{0.30 - 0.45}{(0.012 - 0.018)}$

DIMENSIONS: $\frac{\text{MM}}{(\text{INCHES})}$

Recommended Footprint

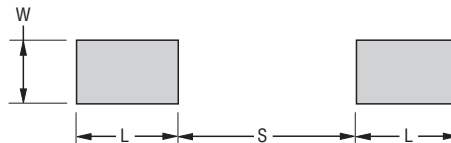

Dimensions (Nominal)	
L	$\frac{0.80}{(0.031)}$
S	$\frac{1.40}{(0.055)}$
W	$\frac{0.50}{(0.020)}$

DIMENSIONS: $\frac{\text{MM}}{(\text{INCHES})}$

Typical Part Marking

Each device has device marking outlined below.

CDSOD323-T24C-DSLQ4D
 (Underline denotes AEC-Q101 compliancy)

Specifications are subject to change without notice.

The device characteristics and parameters in this data sheet can and do vary in different applications and actual device performance may vary over time. Users should verify actual device performance in their specific applications.

CDSOD323-T24C-DSLQ - TVS Diode Series

BOURNS®

Packaging Information

The surface mount product is packaged in an 8 mm x 4 mm tape and reel format per EIA-481 standard.

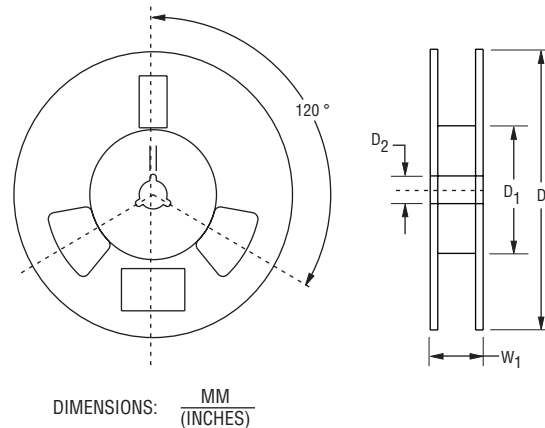
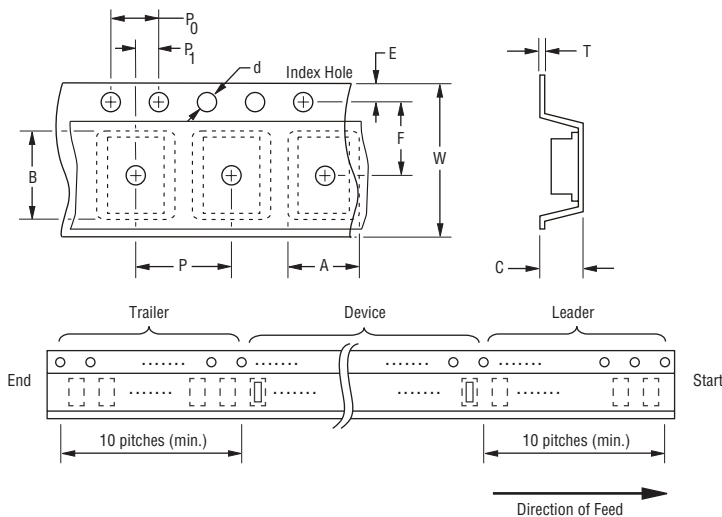

Devices are packed in accordance with EIA standard RS-481-A.

Item	Symbol	SOD-323
Carrier Width	A	$\frac{1.55 \pm 0.10}{(0.061 \pm 0.004)}$
Carrier Length	B	$\frac{2.90 \pm 0.10}{(0.114 \pm 0.004)}$
Carrier Depth	C	$\frac{1.35 \pm 0.10}{(0.053 \pm 0.004)}$
Sprocket Hole	d	$\frac{1.55 \pm 0.05}{(0.061 \pm 0.002)}$
Reel Outside Diameter	D	$\frac{178}{(7.008)}$
Reel Inner Diameter	D ₁	$\frac{80.0}{(3.150)}$ Min.
Feed Hole Diameter	D ₂	$\frac{13.0 \pm 0.20}{(0.512 \pm 0.008)}$
Sprocket Hole Position	E	$\frac{1.75 \pm 0.10}{(0.069 \pm 0.004)}$
Punch Hole Position	F	$\frac{3.50 \pm 0.05}{(0.138 \pm 0.002)}$
Punch Hole Pitch	P	$\frac{4.00 \pm 0.10}{(0.157 \pm 0.004)}$
Sprocket Hole Pitch	P ₀	$\frac{4.00 \pm 0.10}{(0.157 \pm 0.004)}$
Embossment Center	P ₁	$\frac{2.00 \pm 0.05}{(0.079 \pm 0.002)}$
Overall Tape Thickness	T	$\frac{0.20 \pm 0.10}{(0.008 \pm 0.004)}$
Tape Width	W	$\frac{8.00 \pm 0.20}{(0.315 \pm 0.008)}$
Reel Width	W ₁	$\frac{13.5}{(0.531)}$ Max.
Quantity per Reel	--	3,000

BOURNS®

Asia-Pacific:

Tel: +886-2 2562-4117

Email: asiacus@bourns.com

Europe:

Tel: +36 88 520 390

Email: eurocus@bourns.com

The Americas:

Tel: +1-951 781-5500

Email: americus@bourns.com

www.bourns.com