

THIS DOCUMENT IS THE PROPERTY OF
KEYSTONE ELECTRONICS CORP. AND
SHALL NOT BE REPRODUCED, DISTRIBUTED
OR USED AS A BASIS FOR MANUFACTURE
WITHOUT PRIOR WRITTEN PERMISSION
FROM KEYSTONE ELECTRONICS CORP.

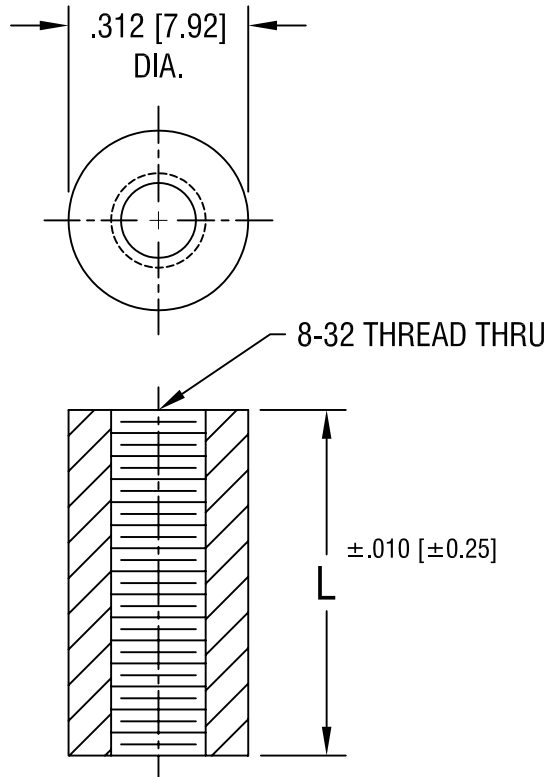

PART NO.	'L' DIM.
460	.250 [6.35]
461	.375 [9.52]
462	.500 [12.70]
463	.750 [19.05]
464	1.000 [25.4]

KEYSTONE ELECTRONICS CORP.

ASTORIA, N.Y. 11105-2017

PART NAME

THREADED ROUND STANDOFF

MATERIAL

PHENOLIC

FINISH

-

DRN BY

BOONE

DATE

5.1.96

APPD

LN

SCALE

3X

TOLERANCES

INCH [MM]

DECIMAL ± .005 [± 0.15]

ANGULAR ± 1°

UNLESS OTHERWISE SPECIFIED

CODE

C/M

DWG NO.

460-464

DATE

DESCRIPTION

REV.