



Technical Data Sheet

5.0mm Round Type LED Lamps

383-2USOC/S530-A4

■ Features :

- Choice of various viewing angles
- Available on tape and reel.
- Reliable and robust
- Pb free
- The product itself will remain within RoHS compliant version.



■ Descriptions :

- The series is specially designed for applications requiring higher brightness
- The led lamps are available with different colors, intensities.

■ Applications :

- TV set
- Monitor
- Telephone
- Computer

PART NO.	Material	Emitted Color	Lens Color
383-2USOC/S530-A4	AlGaInP	Super Sunset Orange	Water Clear

Technical Data Sheet

5.0mm Round Type LED Lamps

383-2USOC/S530-A4

Package Dimensions

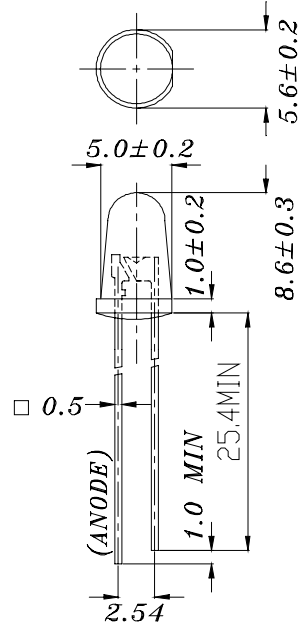

- Notes:
1. All dimensions are in millimetres
 2. The height of flange must be less than 1.5mm(0.059").
 3. Without special declared,the tolerance is ± 0.25 mm.

Absolute Maximum Ratings at $T_a = 25^\circ\text{C}$

Parameter	Symbol	Rating	Unit
Forward Current	I_F	25	mA
Operating Temperature	T_{opr}	-40 to +85	$^\circ\text{C}$
Storage Temperature	T_{stg}	-40 to +100	$^\circ\text{C}$
Soldering Temperature	T_{sol}	260 ± 5	$^\circ\text{C}$
Electrostatic Discharge	ESD	2000	V
Power Dissipation	P_d	60	mW
Reverse Voltage	V_R	5	V

Note: *1:Soldering time ≤ 5 seconds.



Technical Data Sheet
5.0mm Round Type LED Lamps

383-2USOC/S530-A4

Electro-Optical Characteristics (Ta=25°C)

Parameter	Symbol	Condition	Min.	Typ.	Max.	Unit
Forward Voltage	V _F	I _F = 20 mA	/	2.0	2.4	V
Reverse Current	I _R	V _R = 5 V	/	/	10	μA
Luminous Intensity	I _v	I _F = 20 mA	4000	6300	/	mcd
Viewing Angle	2θ 1/2	I _F = 20 mA	/	6	/	deg
Peak Wavelength	λ _p	I _F = 20 mA	/	621	/	nm
Dominant Wavelength	λ _d	I _F = 20 mA	/	615	/	nm
Spectrum Radiation Bandwidth	Δλ	I _F = 20 mA	/	20	/	nm



Technical Data Sheet

5.0mm Round Type LED Lamps

383-2USOC/S530-A4

Typical Electro-Optical Characteristic Curves:

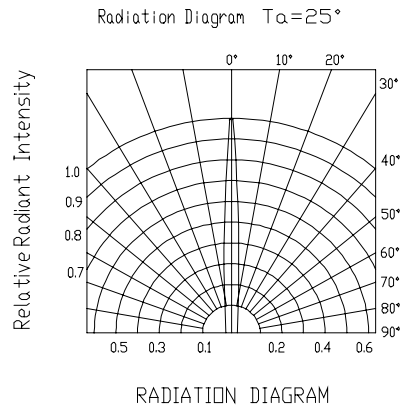
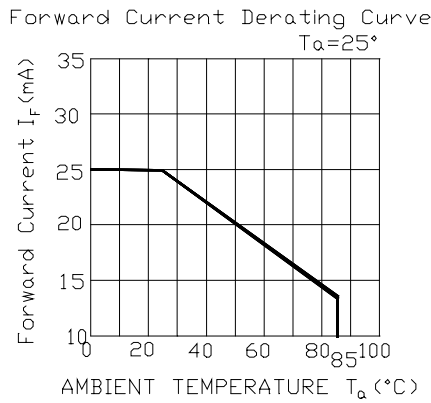
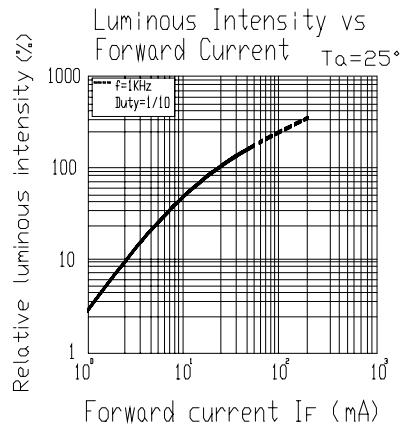
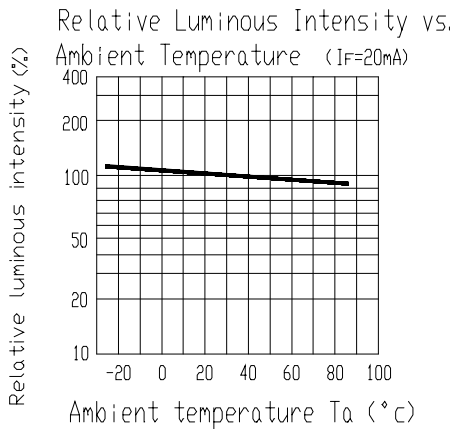
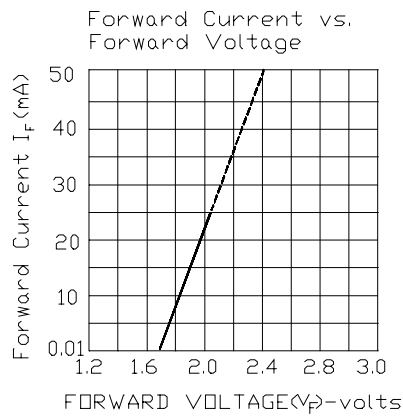
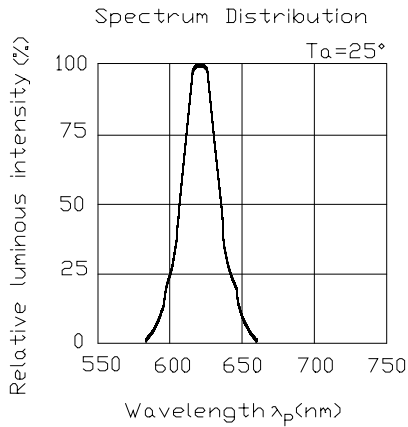



Technical Data Sheet

5.0mm Round Type LED Lamps

383-2USOC/S530-A4

Reliability test items and conditions:

The reliability of products shall be satisfied with items listed below.

Confidence level : 97%

LTPD : 3%

NO	Item	Test Conditions	Test Hours/Cycle	Sample Size	Failure Judgment Criteria	Ac/Re
1	Solder Heat	TEMP : 260°C ± 5 °C	10 SEC	76 PCS	$I_v \leq I_{vt} * 0.5$ or $V_f \geq U$ or $V_f \leq L$	0/1
2	Temperature Cycle	H : +100°C 15min ∫ 5 min L : -40°C 15min	300 CYCLES	76 PCS		0/1
3	Thermal Shock	H : +100°C 5min ∫ 10 sec L : -10°C 5min	300 CYCLES	76 PCS		0/1
4	High Temperature Storage	TEMP : 100°C	1000 HRS	76 PCS		0/1
5	Low Temperature Storage	TEMP : -40°C	1000 HRS	76 PCS		0/1
6	DC Operating Life	TEMP : 25°C I _F = 20mA	1000 HRS	76 PCS		0/1
7	High Temperature / High Humidity	85°C / 85% RH	1000 HRS	76 PCS		0/1

Note : I_{vt} : To test I_v value of the chip before the reliability test
I_v : The test value of the chip that has completed the reliability test
U : Upper Specification Limit
L : Lower Specification Limit



Technical Data Sheet
5.0mm Round Type LED Lamps

383-2USOC/S530-A4

Packing Quantity Specification

1.500PCS/1Bag · 5Bags/1Box

2.10Boxes/1Carton

Label Form Specification



CPN: Customer's Production Number

P/N : Production Number

QTY: Packing Quantity

CAT: Ranks

HUE: Dominant Wavelength

REF: Reference

LOT No: Lot Number

MADE IN TAIWAN: Production Place

CPN:

P/N:



383-2USOC/S530-A4

QTY:

CAT:



HUE:

REF:

LOT NO:EL



MADE IN TAIWAN

Notes

1. Above specification may be changed without notice. EVERLIGHT will reserve authority on material change for above specification.

2. When using this product, please observe the absolute maximum ratings and the instructions for using outlined in these specification sheets. EVERLIGHT assumes no responsibility for any damage resulting from use of the product which does not comply with the absolute maximum ratings and the instructions included in these specification sheets.

3. These specification sheets include materials protected under copyright of EVERLIGHT corporation. Please don't reproduce or cause anyone to reproduce them without EVERLIGHT's consent.

EVERLIGHT ELECTRONICS CO., LTD. Tel: 886-2-2267-2000, 2267-9936
Office: No 25, Lane 76, Sec 3, Chung Yang Rd, Fax: 886-2267-6244, 2267-6189, 2267-6306
Tucheng, Taipei 236, Taiwan, R.O.C http://www.everlight.com