

**Polar™ HiPerFET™**  
**Power MOSFET**

**IXFB30N120P**

N-Channel Enhancement Mode  
Avalanche Rated  
Fast Intrinsic Diode

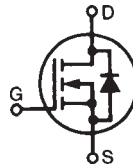

$V_{DSS} = 1200V$   
 $I_{D25} = 30A$   
 $R_{DS(on)} \leq 350m\Omega$   
 $t_{rr} \leq 300ns$

Symbol	Test Conditions	Maximum Ratings	
$V_{DSS}$	$T_J = 25^\circ C$ to $150^\circ C$	1200	V
$V_{DGR}$	$T_J = 25^\circ C$ to $150^\circ C$ , $R_{GS} = 1M\Omega$	1200	V
$V_{GSS}$	Continuous	$\pm 30$	V
$V_{GSM}$	Transient	$\pm 40$	V
$I_{D25}$	$T_C = 25^\circ C$	30	A
$I_{DM}$	$T_C = 25^\circ C$ , Pulse Width Limited by $T_{JM}$	75	A
$I_A$	$T_C = 25^\circ C$	15	A
$E_{AS}$	$T_C = 25^\circ C$	2.0	J
$dv/dt$	$I_S \leq I_{DM}$ , $V_{DD} \leq V_{DSS}$ , $T_J \leq 150^\circ C$	15	V/ns
$P_D$	$T_C = 25^\circ C$	1250	W
$T_J$		-55 ... +150	$^\circ C$
$T_{JM}$		150	$^\circ C$
$T_{stg}$		-55 ... +150	$^\circ C$
$T_L$	1.6mm (0.062 in.) from Case for 10s	300	$^\circ C$
$T_{SOLD}$	Plastic Body for 10s	260	$^\circ C$
$F_C$	Mounting Torque	30..120/6.7..27	N/lb.
<b>Weight</b>		10	g

**PLUS264™**

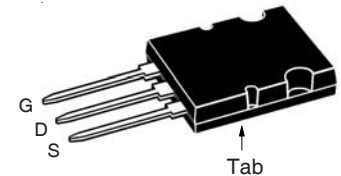

G = Gate      D = Drain  
S = Source    Tab = Drain

**Features**

- Fast Intrinsic Diode
- Avalanche Rated
- Low  $R_{DS(ON)}$  and  $Q_G$
- Low Package Inductance

**Advantages**

- Plus 264™ Package for Clip or Spring Mounting
- High Power Density
- Easy to Mount
- Space Savings

**Applications**

- High Voltage Switch-Mode and Resonant-Mode Power Supplies
- High Voltage Pulse Power Applications
- High Voltage Discharge Circuits in Laser Pulsers
- Spark Igniters, RF Generators
- High Voltage DC-DC Converters
- High Voltage DC-AC Inverters

Symbol	Test Conditions ( $T_J = 25^\circ C$ , Unless Otherwise Specified)	Characteristic Values		
		Min.	Typ.	Max.
$BV_{DSS}$	$V_{GS} = 0V$ , $I_D = 3mA$	1200		V
$V_{GS(th)}$	$V_{DS} = V_{GS}$ , $I_D = 1mA$	3.5		6.5 V
$I_{GSS}$	$V_{GS} = \pm 30V$ , $V_{DS} = 0V$			$\pm 300$ nA
$I_{DSS}$	$V_{DS} = V_{DSS}$ , $V_{GS} = 0V$ $T_J = 125^\circ C$			50 $\mu A$ 5.0 mA
$R_{DS(on)}$	$V_{GS} = 10V$ , $I_D = 0.5 \cdot I_{D25}$ , Note 1			350 m $\Omega$

Symbol	Test Conditions ( $T_J = 25^\circ\text{C}$ Unless Otherwise Specified)	Characteristic Values		
		Min.	Typ.	Max.
$g_{fs}$	$V_{DS} = 20\text{V}, I_D = 0.5 \cdot I_{D25}$ , Note 1	13	22	S
$C_{iss}$	$V_{GS} = 0\text{V}, V_{DS} = 25\text{V}, f = 1\text{MHz}$		22.5	nF
$C_{oss}$			950	pF
$C_{rss}$			28	pF
$R_{Gi}$	Gate Input Resistance		1.64	$\Omega$
$t_{d(on)}$	<b>Resistive Switching Times</b> $V_{GS} = 10\text{V}, V_{DS} = 0.5 \cdot V_{DSS}, I_D = 0.5 \cdot I_{D25}$ $R_G = 1\Omega$ (External)		57	ns
$t_r$			60	ns
$t_{d(off)}$			95	ns
$t_f$			56	ns
$Q_{g(on)}$	$V_{GS} = 10\text{V}, V_{DS} = 0.5 \cdot V_{DSS}, I_D = 0.5 \cdot I_{D25}$		310	nC
$Q_{gs}$			104	nC
$Q_{gd}$			137	nC
$R_{thJC}$			0.10	$^\circ\text{C/W}$
$R_{thCS}$		0.13		$^\circ\text{C/W}$

### Source-Drain Diode

Symbol	Test Conditions ( $T_J = 25^\circ\text{C}$ , Unless Otherwise Specified)	Characteristic Values		
		Min.	Typ.	Max.
$I_S$	$V_{GS} = 0\text{V}$			30 A
$I_{SM}$	Repetitive, Pulse Width Limited by $T_{JM}$			120 A
$V_{SD}$	$I_F = I_S, V_{GS} = 0\text{V}$ , Note 1			1.5 V
$t_{rr}$	$I_F = 0.5 \cdot I_{D25}, V_{GS} = 0\text{V}$ $-di/dt = 100\text{A}/\mu\text{s}$ $V_R = 100\text{V}$			300 ns
$Q_{RM}$			1.6	$\mu\text{C}$
$I_{RM}$			14	A

Note 1: Pulse test,  $t \leq 300\mu\text{s}$ , duty cycle,  $d \leq 2\%$ .

### PLUS264™ (IXFB) Outline

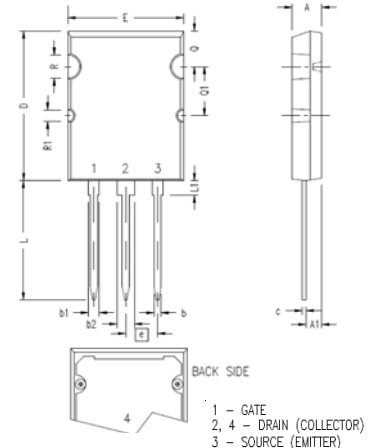

SYM	INCHES		MILLIMETERS	
	MIN	MAX	MIN	MAX
A	.185	.209	4.70	5.31
A1	.102	.118	2.59	3.00
b	.037	.055	0.94	1.40
b1	.087	.102	2.21	2.59
b2	.110	.126	2.79	3.20
c	.017	.029	0.43	0.74
D	1.007	1.047	25.58	26.59
E	.760	.799	19.30	20.29
e	.215 BSC		5.46 BSC	
L	.779	.842	19.79	21.39
L1	.087	.102	2.21	2.59
Q	.240	.256	6.10	6.50
Q1	.330	.346	8.38	8.79
ØR	.155	.187	3.94	4.75
ØR1	.085	.093	2.16	2.36

IXYS Reserves the Right to Change Limits, Test Conditions, and Dimensions.

IXYS MOSFETs and IGBTs are covered by one or more of the following U.S. patents:	4,835,592	4,931,844	5,049,961	5,237,481	6,162,665	6,404,065 B1	6,683,344	6,727,585	7,005,734 B2	7,157,338B2
	4,850,072	5,017,508	5,063,307	5,381,025	6,259,123 B1	6,534,343	6,710,405 B2	6,759,692	7,063,975 B2	
	4,881,106	5,034,796	5,187,117	5,486,715	6,306,728 B1	6,583,505	6,710,463	6,771,478 B2	7,071,537	

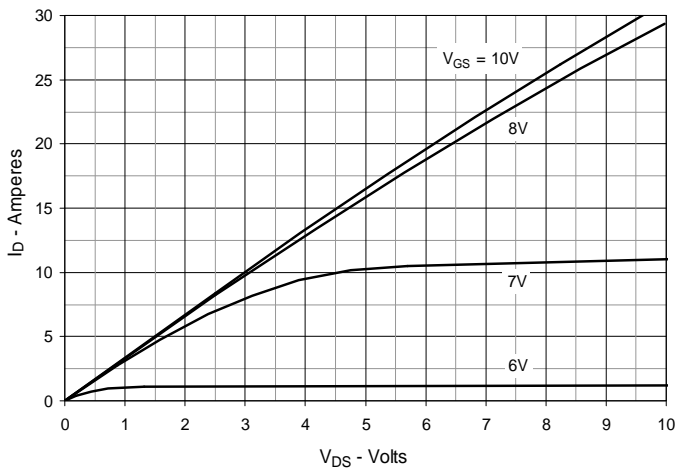
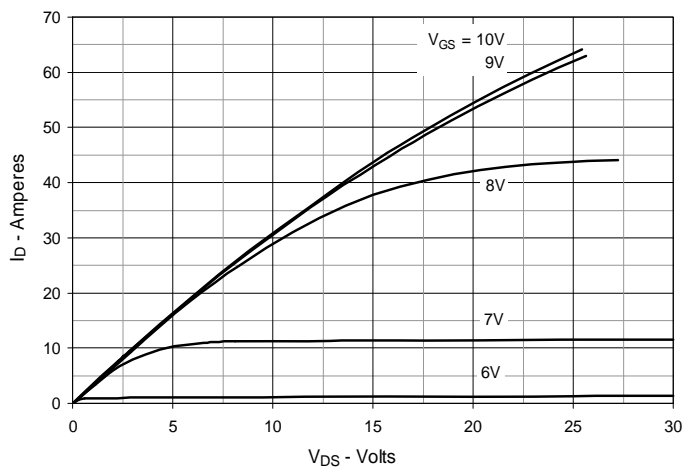
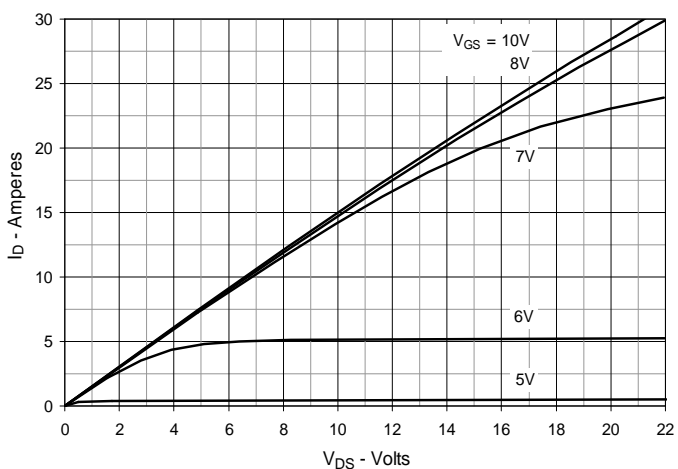
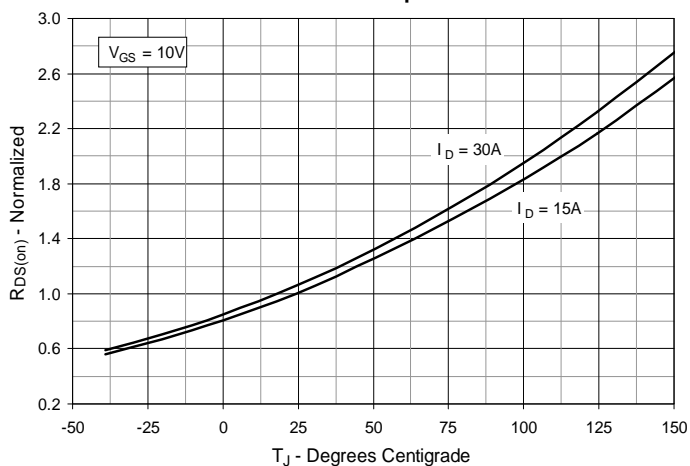
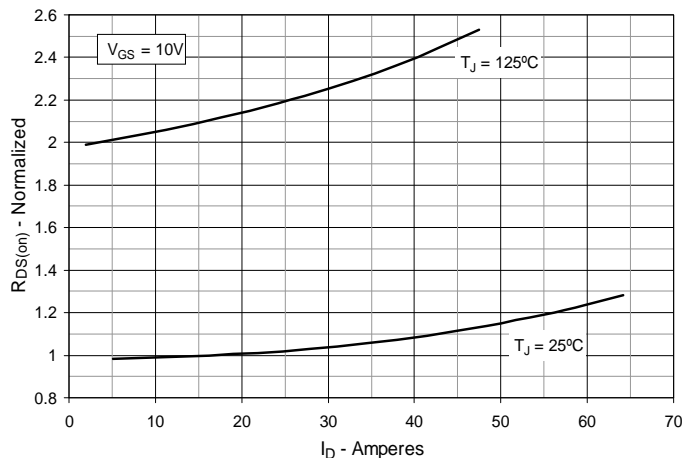
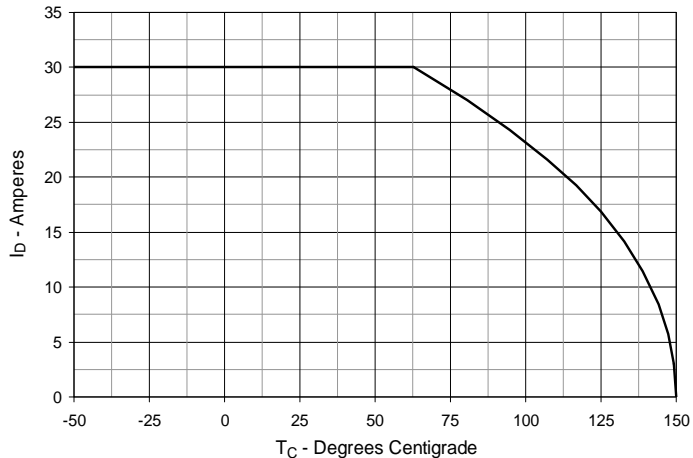
**Fig. 1. Output Characteristics @  $T_J = 25^\circ\text{C}$** 

**Fig. 2. Extended Output Characteristics @  $T_J = 25^\circ\text{C}$** 

**Fig. 3. Output Characteristics @  $T_J = 125^\circ\text{C}$** 

**Fig. 4.  $R_{DS(on)}$  Normalized to  $I_D = 15\text{A}$  Value vs. Junction Temperature**

**Fig. 5.  $R_{DS(on)}$  Normalized to  $I_D = 15\text{A}$  Value vs. Drain Current**

**Fig. 6. Maximum Drain Current vs. Case Temperature**

**Fig. 7. Input Admittance**

**Fig. 8. Transconductance**

**Fig. 9. Forward Voltage Drop of Intrinsic Diode**

**Fig. 10. Gate Charge**

**Fig. 11. Capacitance**

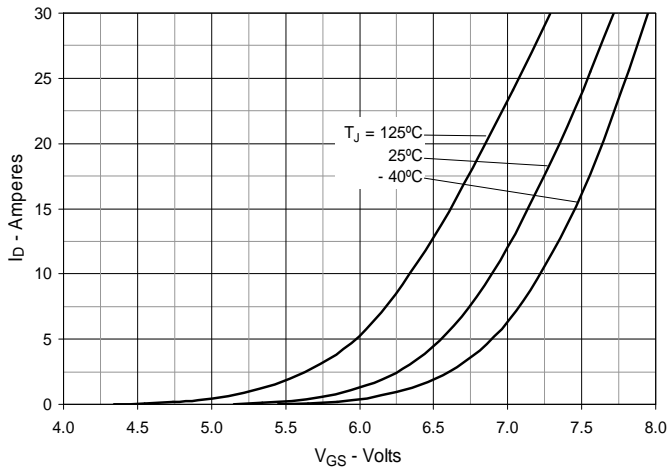
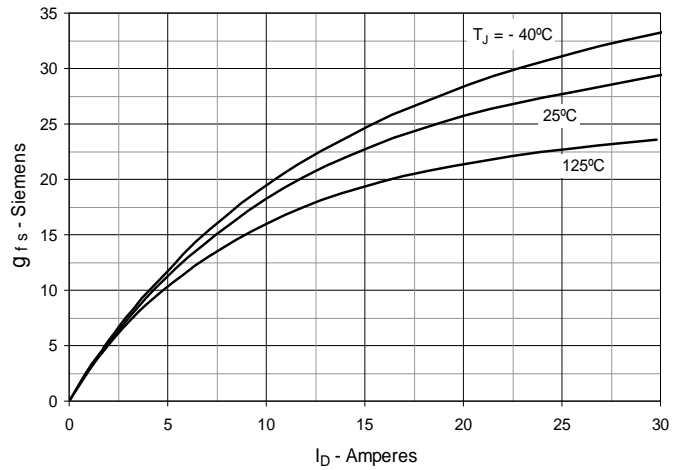
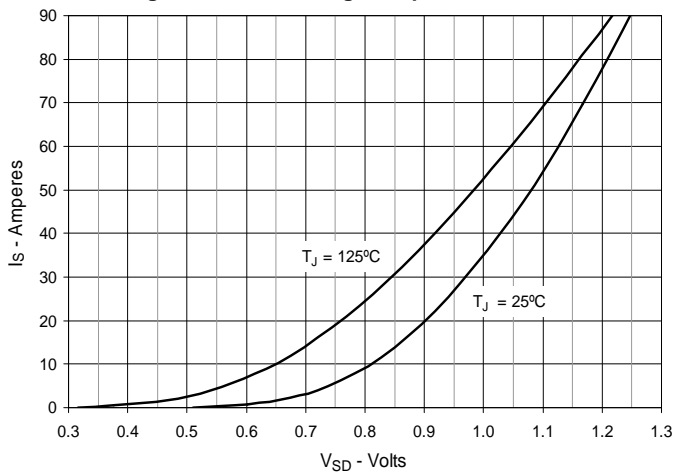
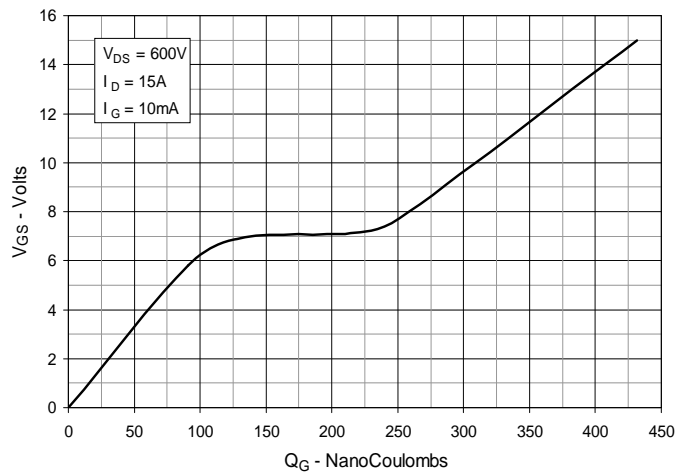
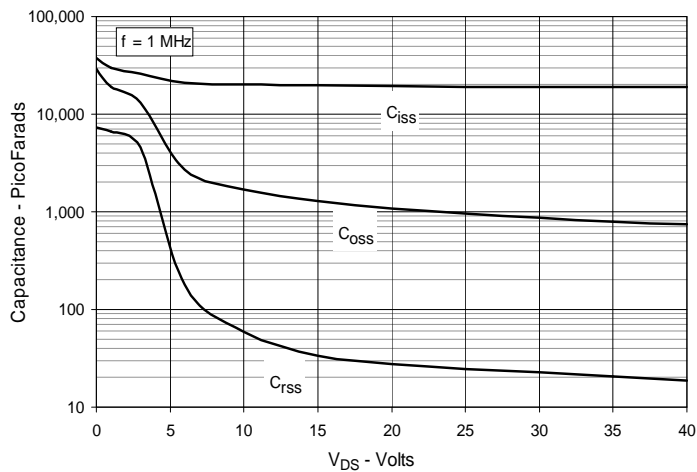
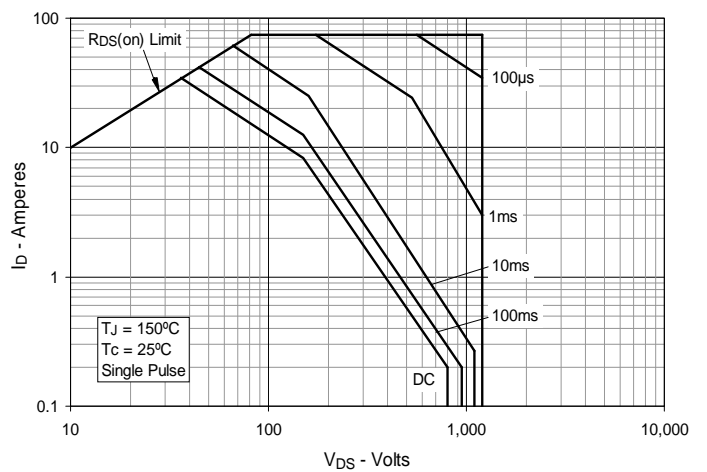
**Fig. 12. Forward-Bias Safe Operating Area**

Fig. 13. Maximum Transient Thermal Impedance

