

## Description

The Advanced Ultra Low Power (AUP) CMOS logic family is designed for low power and extended battery life in portable applications.

The 74AUP2G02 is a dual two-input NOR gate. Both gates have push-pull outputs designed for operation over a power supply range of 0.8 V to 3.6 V. The device is fully specified for partial power down applications using  $I_{OFF}$ . The  $I_{OFF}$  circuitry disables the output preventing damaging current backflow when the device is powered down. Each gate performs the positive Boolean function:

$$Y = \overline{A + B} \text{ or } Y = \overline{A} \bullet \overline{B}$$

## Pin Assignments

(Top View)

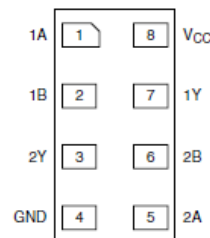

**X2-DFN1210-8**

## Features

- Advanced Ultra Low Power (AUP) CMOS
- Supply Voltage Range from 0.8V to 3.6V
- ±4mA Output Drive at 3.0V
- Low Static Power Consumption  
 $I_{CC} < 0.9\mu A$
- Low Dynamic Power Consumption  
 $C_{PD} = 6 \text{ pF}$  (Typical at 3.6V)
- Schmitt Trigger Action at all inputs makes the circuit tolerant for slower input rise and fall time. The hysteresis is typically 250 mV at  $V_{CC} = 3.0V$
- $I_{OFF}$  Supports Partial-Power-Down Mode Operation
- ESD Protection Exceeds JESD 22  
2000-V Human Body Model (A114)  
Exceeds 1000-V Charged Device Model (C101)
- Latch-Up Exceeds 100mA per JESD 78, Class I
- Leadless Packages Named per JESD30E
- **Totally Lead-Free & Fully RoHS Compliant (Notes 1 & 2)**
- **Halogen and Antimony Free. "Green" Device (Note 3)**

## Applications

- Suited for Battery and Low Power Needs
- Wide array of products such as:
  - Tablets, E-readers
  - Cell Phones, Personal Navigation / GPS
  - MP3 Players, Cameras, Video Recorders
  - PCs, Ultrabooks, Notebooks, Netbooks
  - Computer Peripherals, Hard Drives, SSD, CD/DVD ROM
  - TV, DVD, DVR, Set-Top Box

Notes: 1. No purposely added lead. Fully EU Directive 2002/95/EC (RoHS) & 2011/65/EU (RoHS 2) compliant.  
 2. See [http://www.diodes.com/quality/lead\\_free.html](http://www.diodes.com/quality/lead_free.html) for more information about Diodes Incorporated's definitions of Halogen- and Antimony-free, "Green" and Lead-free.  
 3. Halogen- and Antimony-free "Green" products are defined as those which contain <900ppm bromine, <900ppm chlorine (<1500ppm total Br + Cl) and <1000ppm antimony compounds.

## Ordering Information

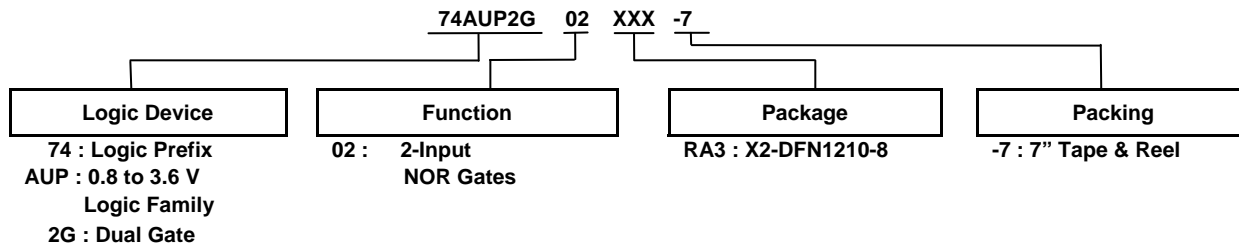

Device	Package Code	Package (Notes 4 & 5)	Package Size	7" Tape and Reel	
				Quantity	Part Number Suffix
74AUP2G02RA3-7	RA3	X2-DFN1210-8	1.2mm X 1.0mm X 0.35mm 0.3 mm lead pitch	5,000/Tape & Reel	-7

Notes: 4. Pad layout as shown on Diodes Inc. suggested pad layout document AP02001, which can be found on our website at <http://www.diodes.com/datasheets/ap02001.pdf>.  
 5. The taping orientation is located on our website at <http://www.diodes.com/datasheets/ap02007.pdf>.

## Pin Descriptions

Pin Name	Pin No.	Function
1A	1	Data Input
1B	2	Data Input
2Y	3	Data Output
GND	4	Ground
2A	5	Data Input
2B	6	Data Input
1Y	7	Data Output
V <sub>CC</sub>	8	Supply Voltage

## Logic Diagram

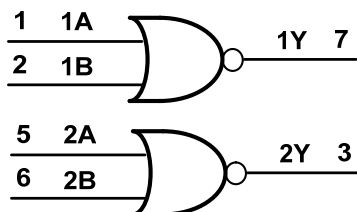

## Function Table

Inputs		Output
A	B	Y
L	L	H
L	H	L
H	L	L
H	H	L

**Absolute Maximum Ratings** (Notes 6 & 7)

Symbol	Description	Rating	Unit
ESD HBM	Human Body Model ESD Protection	2	kV
ESD CDM	Charged Device Model ESD Protection	1	kV
ESD MM	Machine Model ESD Protection	200	V
V <sub>CC</sub>	Supply Voltage Range	-0.5 to +4.6	V
V <sub>I</sub>	Input Voltage Range	-0.5 to +4.6	V
V <sub>O</sub>	Voltage Applied to Output in High or Low State	-0.5 to V <sub>CC</sub> +0.5	V
I <sub>IK</sub>	Input Clamp Current V <sub>I</sub> < 0	50	mA
I <sub>OK</sub>	Output Clamp Current (V <sub>O</sub> < 0)	50	mA
I <sub>O</sub>	Continuous Output Current (V <sub>O</sub> = 0 to V <sub>CC</sub> )	±20	mA
I <sub>CC</sub>	Continuous Current Through V <sub>CC</sub>	50	mA
I <sub>GND</sub>	Continuous Current Through GND	-50	mA
T <sub>J</sub>	Operating Junction Temperature	-40 to +150	°C
T <sub>STG</sub>	Storage Temperature	-65 to +150	°C

- Notes:
- Stresses beyond the absolute maximum may result in immediate failure or reduced reliability. These are stress values and device operation should be within recommend values.
  - Forcing the maximum allowed voltage could cause a condition exceeding the maximum current or conversely forcing the maximum current could cause a condition exceeding the maximum voltage. The ratings of both current and voltage must be maintained within the controlled range.

**Recommended Operating Conditions** (Note 8)

Symbol	Parameter	Min	Max	Unit	
V <sub>CC</sub>	Operating Voltage	0.8	3.6	V	
V <sub>I</sub>	Input Voltage	0	3.6	V	
V <sub>O</sub>	Output Voltage	0	V <sub>CC</sub>	V	
I <sub>OH</sub>	High-Level Output Current	V <sub>CC</sub> = 0.8V	—	-20	μA
		V <sub>CC</sub> = 1.1V	—	-1.1	mA
		V <sub>CC</sub> = 1.4V	—	-1.7	
		V <sub>CC</sub> = 1.65V	—	-1.9	
		V <sub>CC</sub> = 2.3V	—	-3.1	
		V <sub>CC</sub> = 3.0V	—	-4	
I <sub>OL</sub>	Low-Level Output Current	V <sub>CC</sub> = 0.8V	—	20	μA
		V <sub>CC</sub> = 1.1V	—	1.1	mA
		V <sub>CC</sub> = 1.4V	—	1.7	
		V <sub>CC</sub> = 1.65V	—	1.9	
		V <sub>CC</sub> = 2.3V	—	3.1	
		V <sub>CC</sub> = 3.0V	—	4	
Δt/ΔV	Input Transition Rise or Fall Rate	V <sub>CC</sub> = 0.8V to 3.6V	—	200	ns/V
T <sub>A</sub>	Operating Free-Air Temperature	—	-40	+125	°C

- Note: 8. Unused inputs should be held at V<sub>CC</sub> or Ground.

**Electrical Characteristics**

Symbol	Parameter	Test Conditions	V <sub>CC</sub>	T <sub>A</sub> = +25°C		T <sub>A</sub> = -40°C to +85°C		Unit
				Min	Max	Min	Max	
V <sub>IH</sub>	High-Level Input Voltage	—	0.8V to 1.65V	0.80 X V <sub>CC</sub>	—	0.80 X V <sub>CC</sub>	—	V
		—	1.65V to 1.95V	0.65 X V <sub>CC</sub>	—	0.65 X V <sub>CC</sub>	—	
		—	2.3V to 2.7V	1.6	—	1.6	—	
		—	3.0V to 3.6V	2.0	—	2.0	—	
V <sub>IL</sub>	Low-Level Input Voltage	—	0.8V to 1.65V	—	0.30 X V <sub>CC</sub>	—	0.30 X V <sub>CC</sub>	V
		—	1.65V to 1.95V	—	0.35 X V <sub>CC</sub>	—	0.35 X V <sub>CC</sub>	
		—	2.3V to 2.7V	—	0.7	—	0.7	
		—	3.0V to 3.6V	—	0.9	—	0.9	
V <sub>OH</sub>	High-Level Output Voltage	I <sub>OH</sub> = -20μA	0.8V to 3.6V	V <sub>CC</sub> - 0.1	—	V <sub>CC</sub> - 0.1	—	V
		I <sub>OH</sub> = -1.1mA	1.1V	0.75 X V <sub>CC</sub>	—	0.7 X V <sub>CC</sub>	—	
		I <sub>OH</sub> = -1.7mA	1.4V	1.11	—	1.03	—	
		I <sub>OH</sub> = -1.9mA	1.65V	1.32	—	1.3	—	
		I <sub>OH</sub> = -2.3mA	2.3V	2.05	—	1.97	—	
		I <sub>OH</sub> = -3.1mA		1.9	—	1.85	—	
		I <sub>OH</sub> = -2.7mA	3V	2.72	—	2.67	—	
		I <sub>OH</sub> = -4mA		2.6	—	2.55	—	
V <sub>OL</sub>	Low-Level Input Voltage	I <sub>OL</sub> = 20μA	0.8V to 3.6V	—	0.1	—	0.1	V
		I <sub>OL</sub> = 1.1mA	1.1V	—	0.3 X V <sub>CC</sub>	—	0.3 X V <sub>CC</sub>	
		I <sub>OL</sub> = 1.7mA	1.4V	—	0.31	—	0.37	
		I <sub>OL</sub> = 1.9mA	1.65V	—	0.31	—	0.35	
		I <sub>OL</sub> = 2.3mA	2.3V	—	0.31	—	0.33	
		I <sub>OL</sub> = 3.1mA		—	0.44	—	0.45	
		I <sub>OL</sub> = 2.7mA	3V	—	0.31	—	0.33	
		I <sub>OL</sub> = 4mA		—	0.44	—	0.45	
I <sub>I</sub>	Input Current	A or B Input V <sub>I</sub> = GND to 3.6V	0V to 3.6V	—	± 0.1	—	± 0.5	μA
I <sub>OFF</sub>	Power Down Leakage Current	V <sub>I</sub> or V <sub>O</sub> = 0V to 3.6V	0V	—	± 0.2	—	± 0.6	μA
ΔI <sub>OFF</sub>	Delta Power Down Leakage Current	V <sub>I</sub> or V <sub>O</sub> = 0V to 3.6V	0V to 0.2V	—	± 0.2	—	± 0.6	μA
I <sub>CC</sub>	Supply Current	V <sub>I</sub> = GND or V <sub>CC</sub> , I <sub>O</sub> = 0	0.8V to 3.6V	—	0.5	—	0.9	μA
ΔI <sub>CC</sub>	Additional Supply Current	One Input at V <sub>CC</sub> - 0.6V Other Inputs at V <sub>CC</sub> or GND	3.3V	—	40	—	50	μA

**Electrical Characteristics** (continued)

Symbol	Parameter	Test Conditions	V <sub>CC</sub>	T <sub>A</sub> = -40°C to +125°C		Unit
				Min	Max	
V <sub>IH</sub>	High-Level Input Voltage	—	0.8V to 1.65V	0.80 X V <sub>CC</sub>	—	V
		—	1.65V to 1.95V	0.70 X V <sub>CC</sub>	—	
		—	2.3V to 2.7V	1.6	—	
		—	3.0V to 3.6V	2.0	—	
V <sub>IL</sub>	Low-Level Input Voltage	—	0.8V to 1.65V	—	0.25 X V <sub>CC</sub>	V
		—	1.65V to 1.95V	—	0.30 X V <sub>CC</sub>	
		—	2.3V to 2.7V	—	0.7	
		—	3.0V to 3.6V	—	0.9	
V <sub>OH</sub>	High-Level Output Voltage	I <sub>OH</sub> = -20μA	0.8V to 3.6V	V <sub>CC</sub> - 0.11	—	V
		I <sub>OH</sub> = -1.1mA	1.1V	0.6 X V <sub>CC</sub>	—	
		I <sub>OH</sub> = -1.7mA	1.4V	0.93	—	
		I <sub>OH</sub> = -1.9mA	1.65V	1.17	—	
		I <sub>OH</sub> = -2.3mA	2.3V	1.77	—	
		I <sub>OH</sub> = -3.1mA		1.67	—	
		I <sub>OH</sub> = -2.7mA	3V	2.40	—	
		I <sub>OH</sub> = -4mA		2.30	—	
V <sub>OL</sub>	Low-Level Input Voltage	I <sub>OL</sub> = 20μA	0.8V to 3.6V	—	0.11	V
		I <sub>OL</sub> = 1.1mA	1.1V	—	0.33 X V <sub>CC</sub>	
		I <sub>OL</sub> = 1.7mA	1.4V	—	0.41	
		I <sub>OL</sub> = 1.9mA	1.65V	—	0.39	
		I <sub>OL</sub> = 2.3mA	2.3V	—	0.36	
		I <sub>OL</sub> = 3.1mA		—	0.50	
		I <sub>OL</sub> = 2.7mA	3V	—	0.36	
		I <sub>OL</sub> = 4mA		—	0.50	
I <sub>I</sub>	Input Current	A or B Input, V <sub>I</sub> = GND to 3.6V	0V to 3.6V	—	± 0.75	μA
I <sub>OFF</sub>	Power Down Leakage Current	V <sub>I</sub> or V <sub>O</sub> = 0V to 3.6V	0V	—	± 1.0	μA
ΔI <sub>OFF</sub>	Delta Power Down Leakage Current	V <sub>I</sub> or V <sub>O</sub> = 0V to 3.6V	0V to 0.2V	—	± 2.5	μA
I <sub>CC</sub>	Supply Current	V <sub>I</sub> = GND or V <sub>CC</sub> , I <sub>O</sub> = 0	0.8V to 3.6V	—	3.0	μA
ΔI <sub>CC</sub>	Additional Supply Current	Input at V <sub>CC</sub> - 0.6V Other Inputs at V <sub>CC</sub> or GND	3.3V	—	75	μA

**Operating and Package Characteristics** (@T<sub>A</sub> = +25°C, unless otherwise specified.)

Parameter		Test Conditions		V <sub>CC</sub>	Typ	Unit
C <sub>pd</sub>	Power Dissipation Capacitance	f = 1MHz No Load		0.8V	5.1	pF
				1.2V ± 0.1V	5.2	
				1.5V ± 0.1V	5.2	
				1.8V ± 0.15V	5.5	
				2.5V ± 0.2V	5.7	
				3.3V ± 0.3V	6.0	
C <sub>i</sub>	Input Capacitance	V <sub>I</sub> = V <sub>CC</sub> or GND		0V or 3.3V	2.0	pF
θ <sub>JA</sub>	Thermal Resistance Junction-to-Ambient	X2-DFN1210-8	(Note 9)	—	+395	°C/W
θ <sub>JC</sub>	Thermal Resistance Junction-to-Case	X2-DFN1210-8	(Note 9)	—	+236	°C/W

Note: 9. Test condition, X2-DFN1210-8 device mounted on FR-4 substrate PC board, 2oz copper, with minimum recommended pad layout.

**Switching Characteristics**
 $C_L = 5\text{pF}$ , See Figure 1

Parameter	From Input	To Output	V <sub>cc</sub>	T <sub>A</sub> = +25°C			T <sub>A</sub> = -40°C to +85°C		T <sub>A</sub> = -40°C to +125°C		Unit
				Min	Typ	Max	Min	Max	Min	Max	
t <sub>pd</sub>	A or B	Y	0.8V	—	19.6	—	—	—	—	—	ns
			1.2V ± 0.1V	2.5	5.1	11.9	2.1	13.3	2.1	14.7	
			1.5V ± 0.1V	1.6	3.7	6.7	1.4	7.8	1.4	8.6	
			1.8V ± 0.15V	1.3	3.0	5.3	1.1	6.2	1.1	6.9	
			2.5V ± 0.2V	1.0	2.4	3.9	0.9	4.6	0.9	5.1	
			3.3V ± 0.3V	1.0	2.2	3.4	0.8	4.0	0.8	4.4	

 $C_L = 10\text{pF}$ , See Figure 1

Parameter	From Input	To Output	V <sub>cc</sub>	T <sub>A</sub> = +25°C			T <sub>A</sub> = -40°C to +85°C		T <sub>A</sub> = -40°C to +125°C		Unit
				Min	Typ	Max	Min	Max	Min	Max	
t <sub>pd</sub>	A or B	Y	0.8V	—	23.5	—	—	—	—	—	ns
			1.2V ± 0.1V	2.4	6.0	14.1	2.2	15.7	2.2	17.4	
			1.5V ± 0.1V	1.9	4.3	7.9	1.7	9.2	1.7	10.2	
			1.8V ± 0.15V	1.6	3.6	6.2	1.5	7.3	1.5	8.1	
			2.5V ± 0.2V	1.4	3.0	4.7	1.2	5.6	1.2	6.2	
			3.3V ± 0.3V	1.3	2.7	4.2	1.2	5.0	1.2	5.5	

 $C_L = 15\text{pF}$ , See Figure 1

Parameter	From Input	To Output	V <sub>cc</sub>	T <sub>A</sub> = +25°C			T <sub>A</sub> = -40°C to +85°C		T <sub>A</sub> = -40°C to +125°C		Unit
				Min	Typ	Max	Min	Max	Min	Max	
t <sub>pd</sub>	A or B	Y	0.8V	—	27.5	—	—	—	—	—	ns
			1.2V ± 0.1V	3.4	6.8	16.1	3.1	20.2	3.1	20.4	
			1.5V ± 0.1V	2.3	4.8	8.9	2.0	10.4	2.0	11.5	
			1.8V ± 0.15V	1.9	4.0	7.0	1.7	8.3	1.7	9.2	
			2.5V ± 0.2V	1.7	3.4	5.4	1.5	6.3	1.5	7.0	
			3.3V ± 0.3V	1.4	3.2	4.8	1.3	5.7	1.3	6.3	

 $C_L = 30\text{pF}$ , See Figure 1

Parameter	From Input	To Output	V <sub>cc</sub>	T <sub>A</sub> = +25°C			T <sub>A</sub> = -40°C to +85°C		T <sub>A</sub> = -40°C to +125°C		Unit
				Min	Typ	Max	Min	Max	Min	Max	
t <sub>pd</sub>	A or B	Y	0.8V	—	39.3	—	—	—	—	—	ns
			1.2V ± 0.1V	4.6	9.0	21.9	4.1	27.6	4.1	27.8	
			1.5V ± 0.1V	3.4	6.4	11.8	2.9	13.9	2.9	15.3	
			1.8V ± 0.15V	2.6	5.3	9.3	2.3	11.1	2.3	12.3	
			2.5V ± 0.2V	2.4	4.5	7.1	2.1	8.5	2.1	9.4	
			3.3V ± 0.3V	2.0	4.2	6.4	1.8	7.7	1.8	8.5	

**Parameter Measurement Information**

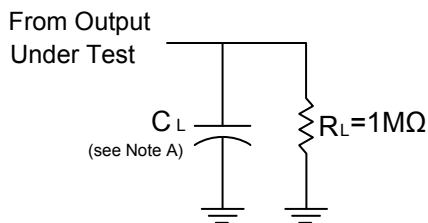

$V_{CC}$	Inputs		$V_M$	$C_L$
	$V_I$	$t_r/t_f$		
0.8V	$V_{CC}$	$\leq 3ns$	$V_{CC}/2$	5, 10, 15, 30pF
$1.2V \pm 0.1V$	$V_{CC}$	$\leq 3ns$	$V_{CC}/2$	5, 10, 15, 30pF
$1.5V \pm 0.1V$	$V_{CC}$	$\leq 3ns$	$V_{CC}/2$	5, 10, 15, 30pF
$1.8V \pm 0.15V$	$V_{CC}$	$\leq 3ns$	$V_{CC}/2$	5, 10, 15, 30pF
$2.5V \pm 0.2V$	$V_{CC}$	$\leq 3ns$	$V_{CC}/2$	5, 10, 15, 30pF
$3.3V \pm 0.3V$	$V_{CC}$	$\leq 3ns$	$V_{CC}/2$	5, 10, 15, 30pF

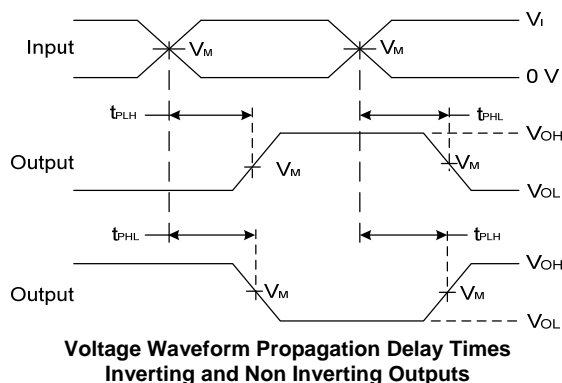
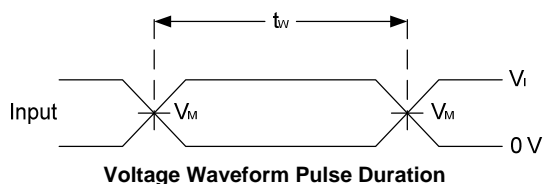

**Figure 1 Load Circuit and Voltage Waveforms**

- Notes:
- A. Includes test lead and test apparatus capacitance.
  - B. All pulses are supplied at pulse repetition rate  $\leq 10$  MHz.
  - C. Inputs are measured separately one transition per measurement.
  - D.  $t_{PLH}$  and  $t_{PHL}$  are the same as  $t_{PD}$ .

## Marking Information

### X2-DFN1210-8

( Top View )

XX : Identification Code

Y : Year : 0~9

W : week : A~Z : 1~26 week

a~z : 27-52 week

z represents 52 and 53 week

X : week : A~Z : Internal code

Part Number	Package	Identification Code
74AUP2G02RA3-7	X2-DFN1210-8	BT

## X2-DFN1210-8 Package Outline Dimensions and Suggested Pad Layout

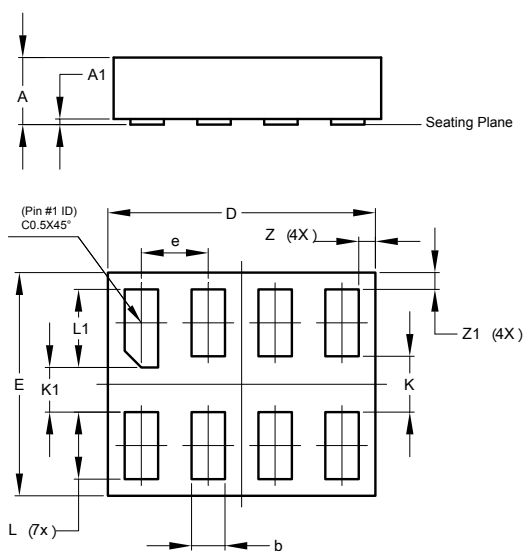
 Please see AP02002 at <http://www.diodes.com/datasheets/ap02002.pdf> for the latest version.

X2-DFN1210-8			
Dim	Min	Max	Typ
A	-	0.35	0.30
A1	0	0.03	0.02
b	0.10	0.20	0.15
D	1.15	1.25	1.20
E	0.95	1.05	1.00
e	-	-	0.30
K	-	-	0.25
K1	-	-	0.20
L	0.25	0.35	0.30
L1	0.30	0.40	0.35
Z	0.050	0.100	0.075
Z1	0.050	0.100	0.075
All Dimensions in mm			

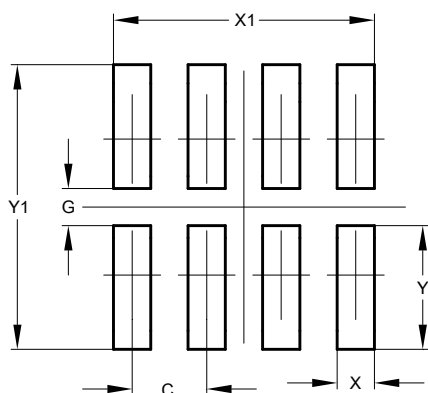

Dimensions	Value (in mm)
C	0.300
G	0.150
X	0.150
X1	1.050
Y	0.500
Y1	1.150



### IMPORTANT NOTICE

DIODES INCORPORATED MAKES NO WARRANTY OF ANY KIND, EXPRESS OR IMPLIED, WITH REGARDS TO THIS DOCUMENT, INCLUDING, BUT NOT LIMITED TO, THE IMPLIED WARRANTIES OF MERCHANTABILITY AND FITNESS FOR A PARTICULAR PURPOSE (AND THEIR EQUIVALENTS UNDER THE LAWS OF ANY JURISDICTION).

Diodes Incorporated and its subsidiaries reserve the right to make modifications, enhancements, improvements, corrections or other changes without further notice to this document and any product described herein. Diodes Incorporated does not assume any liability arising out of the application or use of this document or any product described herein; neither does Diodes Incorporated convey any license under its patent or trademark rights, nor the rights of others. Any Customer or user of this document or products described herein in such applications shall assume all risks of such use and will agree to hold Diodes Incorporated and all the companies whose products are represented on Diodes Incorporated website, harmless against all damages.

Diodes Incorporated does not warrant or accept any liability whatsoever in respect of any products purchased through unauthorized sales channel.

Should Customers purchase or use Diodes Incorporated products for any unintended or unauthorized application, Customers shall indemnify and hold Diodes Incorporated and its representatives harmless against all claims, damages, expenses, and attorney fees arising out of, directly or indirectly, any claim of personal injury or death associated with such unintended or unauthorized application.

Products described herein may be covered by one or more United States, international or foreign patents pending. Product names and markings noted herein may also be covered by one or more United States, international or foreign trademarks.

This document is written in English but may be translated into multiple languages for reference. Only the English version of this document is the final and determinative format released by Diodes Incorporated.

### LIFE SUPPORT

Diodes Incorporated products are specifically not authorized for use as critical components in life support devices or systems without the express written approval of the Chief Executive Officer of Diodes Incorporated. As used herein:

A. Life support devices or systems are devices or systems which:

1. are intended to implant into the body, or
2. support or sustain life and whose failure to perform when properly used in accordance with instructions for use provided in the labeling can be reasonably expected to result in significant injury to the user.

B. A critical component is any component in a life support device or system whose failure to perform can be reasonably expected to cause the failure of the life support device or to affect its safety or effectiveness.

Customers represent that they have all necessary expertise in the safety and regulatory ramifications of their life support devices or systems, and acknowledge and agree that they are solely responsible for all legal, regulatory and safety-related requirements concerning their products and any use of Diodes Incorporated products in such safety-critical, life support devices or systems, notwithstanding any devices- or systems-related information or support that may be provided by Diodes Incorporated. Further, Customers must fully indemnify Diodes Incorporated and its representatives against any damages arising out of the use of Diodes Incorporated products in such safety-critical, life support devices or systems.

Copyright © 2015, Diodes Incorporated

[www.diodes.com](http://www.diodes.com)