

CREATE YOUR OWN SPEAKER DOCK WITH THIS

# MONO AMPLIFIER KIT

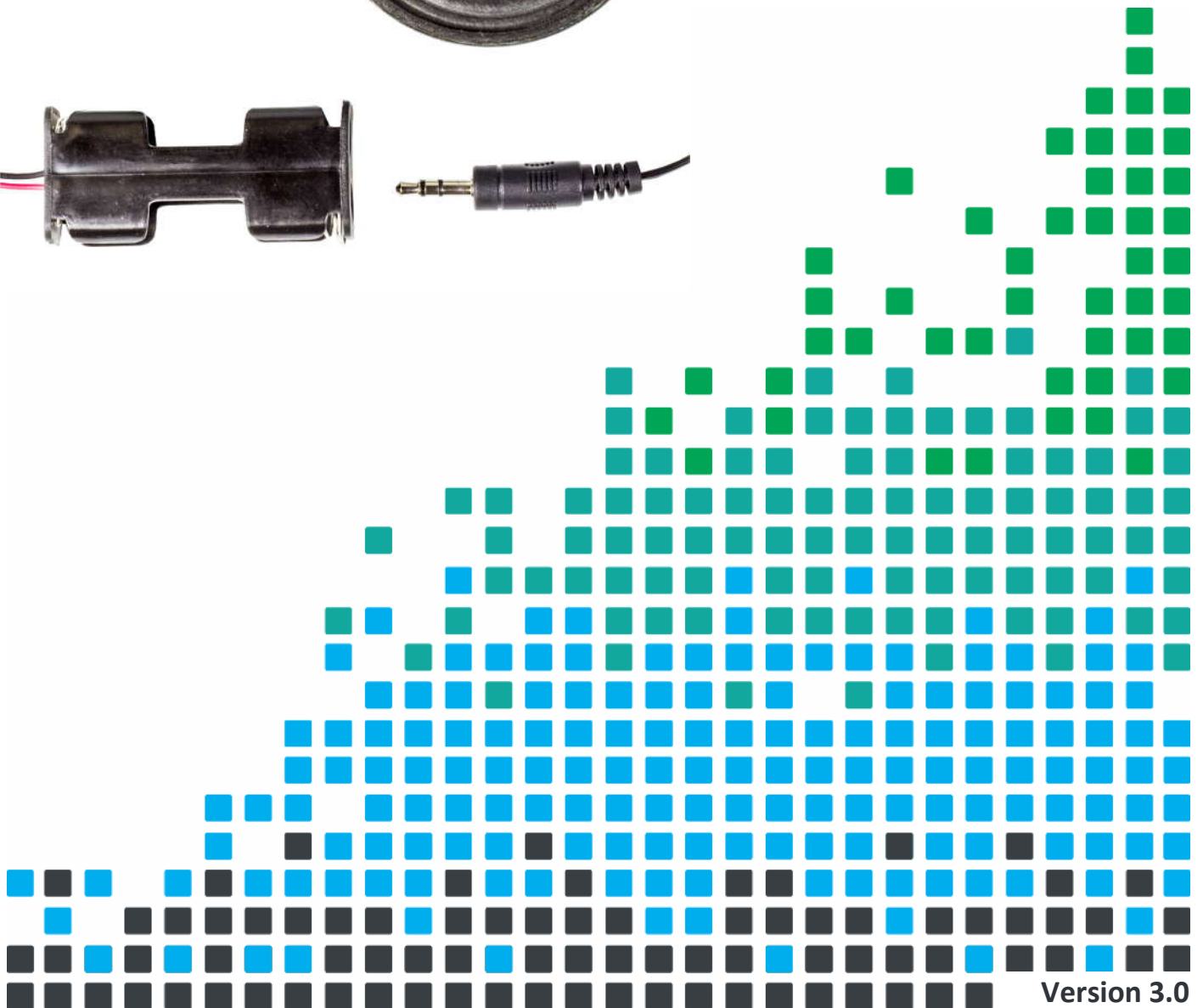
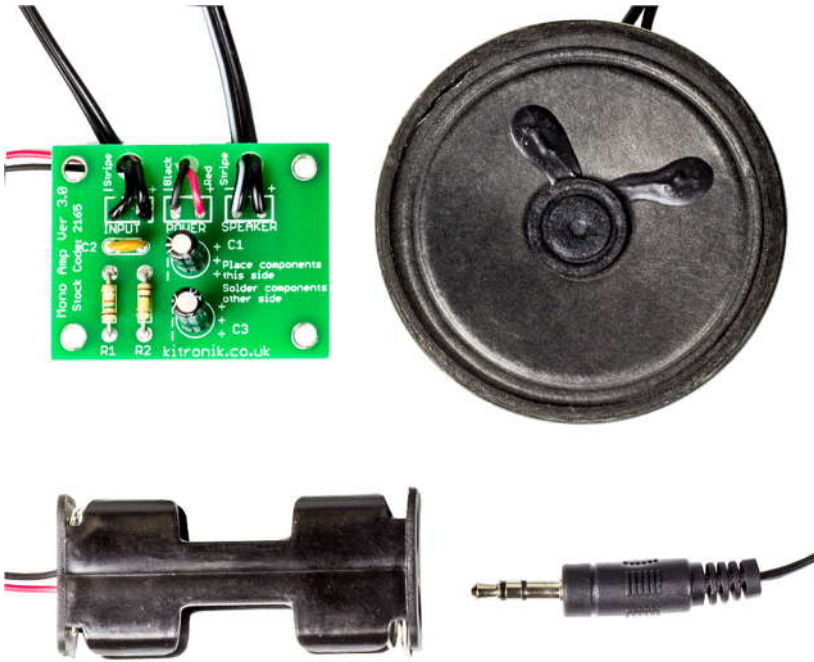

## Index of Sheets

### TEACHING RESOURCES

- Index of Sheets
- Introduction
- Schemes of Work
- Answers
- The Design Process
- The Design Brief
- Investigation / Research
- Developing a Specification
- Which Batteries Should I Use With My MP3 Amplifier?
- Mounting the Speaker
- Design
- Design Review (group task)
- Soldering In Ten Steps
- Resistor Values
- Capacitor Basics
- Ceramic Disc Capacitors
- Instruction Manual
- Evaluation
- Packaging Design

### ESSENTIAL INFORMATION

- Build Instructions
- Checking Your Amplifier PCB
- Adding an On / Off Switch
- Designing the Enclosure
- How the Amplifier Works
- Online Information



## Introduction

### ***About the project kit***

Both the project kit and supporting material have been carefully designed for use in KS3 Design and Technology lessons. It is designed so that even teachers with a limited knowledge of electronics should have no trouble using it as a basis from which they can form a scheme of work.

The project kits can be used in two ways:

1. As part of a larger project involving all aspects of a product design, such as designing an enclosure for the electronics to fit into.
2. On their own as a way of introducing electronics and electronic construction to students over a number of lessons.

This booklet contains a wealth of material to aid the teacher in either case.

### ***Using the booklet***

The first few pages of this booklet contain the information to aid the teacher in planning their lessons and also cover worksheet answers. The rest of the booklet is designed to be printed out as classroom handouts. In most cases all of the sheets will not be needed and therefore they don't contain page numbers, allowing teachers to pick and choose as they feel fit.

Please feel free to print any pages of this booklet to use as student handouts in conjunction with Kitronik project kits.

### ***Support and resources***

You can also find additional resources at [www.kitronik.co.uk](http://www.kitronik.co.uk). There are component fact sheets, information on calculating resistor and capacitor values, puzzles and much more.

Kitronik provide a next day response technical assistance service via e-mail. If you have any questions regarding this kit or even suggestions for improvements, please e-mail us at:

support@kitronik.co.uk

Alternatively, phone us on 0845 8380781.



## Schemes of Work

Two schemes of work are included in this pack; the first is a complete project including the design & manufacture of an enclosure for the kit (below). The second is a much shorter focused practical task covering just the assembly of the kit (next page). Equally, feel free to use the material as you see fit to develop your own schemes.

Before starting we would advise that you to build a kit yourself. This will allow you to become familiar with the project and will provide a unit to demonstrate.

### ***Complete product design project including electronics and enclosure***

Hour 1	Introduce the task using 'The Design Brief' sheet. Demonstrate a built unit. Take students through the design process using 'The Design Process' sheet. <u>Homework</u> : Collect examples of MP3 players & accessories. List the common features of these products on the 'Investigation / Research' sheet.
Hour 2	Develop a specification for the project using the 'Developing a Specification' sheet. <u>Resource</u> : Sample of products (amplifiers & MP3 player accessories). <u>Homework</u> : Using the internet or other search method, find out what is meant by 'design for manufacture'. List five reasons why design for manufacture should be considered on any design project.
Hour 3	Read 'Designing the Enclosure' sheet. Develop a product design using the 'Design' sheet. <u>Homework</u> : Complete design.
Hour 4	Using cardboard, get the students to model their enclosure design. Allow them to make alterations to their design if the model shows any areas that need changing.
Hour 5	Split the students into groups and get them to perform a group design review using the 'Design Review' sheet.
Hour 6	Using the 'Soldering in 8 Steps' sheet, demonstrate and get students to practice soldering. Start the 'Resistor Value' and 'Ceramic Disc Capacitors' worksheets. <u>Homework</u> : Complete any of the remaining resistor / capacitor tasks.
Hour 7	Build the electronic kit using the 'Build Instructions'.
Hour 8	Complete the build of the electronic kit. Check the completed PCB and fault find if required using the 'Checking Your Amplifier PCB' section and the fault finding flow chart. <u>Homework</u> : Read 'How the Amplifier Works' sheet.
Hour 9	Build the enclosure. <u>Homework</u> : Collect some examples of instruction manuals.
Hour 10	Build the enclosure. <u>Homework</u> : Read 'Instruction Manual' sheet and start developing instructions for the amplifier.
Hour 11	Build the enclosure.
Hour 12	Using the 'Evaluation' and 'Improvement' sheet, get the students to evaluate their final product and state where improvements can be made.

### **Additional Work**

Package design for those who complete ahead of others.



## Electronics only

Hour 1	Introduction to the kit demonstrating a built unit. Using 'Soldering in 8 Steps' sheet practice soldering.
Hour 2	Build the kit using the 'Build Instructions'.
Hour 3	Check the completed PCB and fault find if required using 'Checking Your Amplifier PCB' and fault finding flow chart.

## Answers

### Resistor questions

1st Band	2nd Band	Multiplier x	Value
Brown	Black	Yellow	100,000 $\Omega$
Green	Blue	Brown	560 $\Omega$
Brown	Grey	Yellow	180,000 $\Omega$
Orange	White	Black	39 $\Omega$

Value	1st Band	2nd Band	Multiplier x
180 $\Omega$	Brown	Grey	Brown
3,900 $\Omega$	Orange	White	Red
47,000 (47K) $\Omega$	Yellow	Violet	Orange
1,000,000 (1M) $\Omega$	Brown	Black	Green

### Capacitor ceramic disc values

Printing on capacitor	Two digit start	Number of zero's	Value in pF
222	22	00	2200pF (2.2nF)
103	10	000	10000pF (10nF)
333	33	000	33000pF (33nF)
473	47	000	47000pF (47nF)



## The Design Process

The design process can be short or long, but will always consist of a number of steps that are the same on every project. By splitting a project into these clearly defined steps, it becomes more structured and manageable. The steps allow clear focus on a specific task before moving to the next phase of the project. A typical design process is shown on the right.

### **Design brief**

What is the purpose or aim of the project? Why is it required and who is it for?

### **Investigation**

Research the background of the project. What might the requirements be? Are there competitors and what are they doing? The more information found out about the problem at this stage, the better, as it may make a big difference later in the project.

### **Specification**

This is a complete list of all the requirements that the project must fulfil - no matter how small. This will allow you to focus on specifics at the design stage and to evaluate your design. Missing a key point from a specification can result in a product that does not fulfil its required task.

### **Design**

Develop your ideas and produce a design that meets the requirements listed in the specification. At this stage it is often normal to prototype some of your ideas to see which work and which do not.

### **Build**

Build your design based upon the design that you have developed.

### **Evaluate**

Does the product meet all points listed in the specification? If not, return to the design stage and make the required changes. Does it then meet all of the requirements of the design brief? If not, return to the specification stage and make improvements to the specification that will allow the product to meet these requirements and repeat from this point. It is normal to have such iterations in design projects, though you normally aim to keep these to a minimum.

### **Improve**

Do you feel the product could be improved in any way? These improvements can be added to the design.

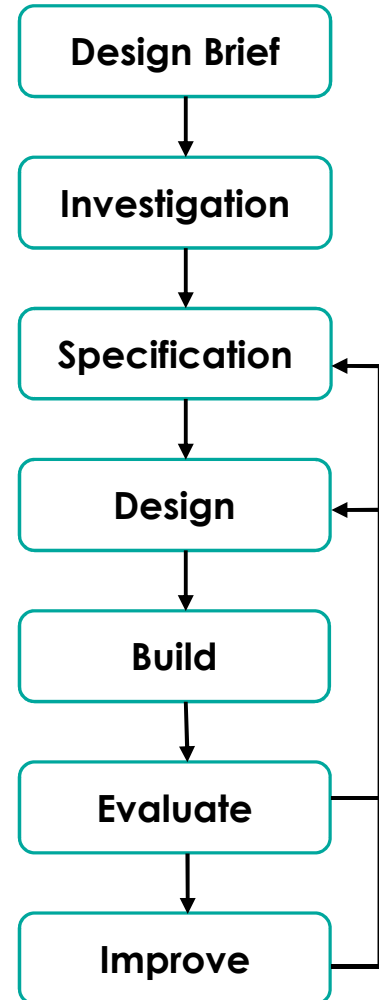

## The Design Brief

A manufacturer of MP3 players has developed a simple audio amplifier circuit. The circuit has been developed to the point where they have a working Printed Circuit Board (PCB). Although they are used to the design of MP3 players, they have not designed an amplifier case before.

The manufacturer would like ideas for an enclosure for the PCB, batteries and speaker to be mounted in. The manufacturer has asked you to do this for them. It is important that you make sure the final design meets all of the requirements that you identify for such a product.



## Complete circuit

A fully built circuit is shown below.

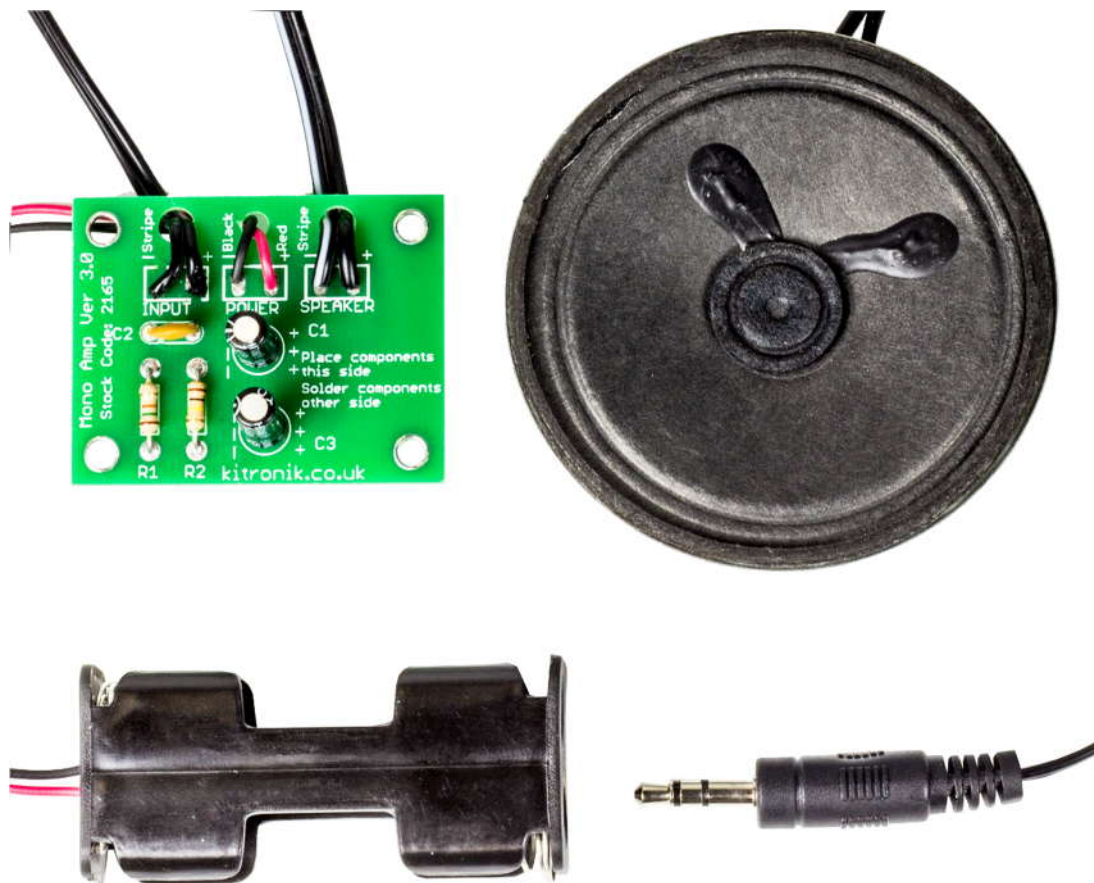



## Investigation / Research

Using a number of different search methods, find examples of similar products that are already on the market. Use additional pages if required.

Name.....

Class.....





## Developing a Specification

Using your research into the target market for the product, identify the key requirements for the product and explain why each of these is important.

Name.....







Class.....

Requirement	Reason
Example: The enclosure should have some holes.	Example: So that the sound can be heard.



## Which Batteries Should I Use With My MP3 Amplifier?

The Amplifier will work off a supply of 2.2 volts to 5.5 volts; however you won't be able to set the volume as high on the lower voltages. The higher the voltage, the more batteries you will need and the bulkier the case will have to be to accommodate them. You might also want to consider how long the amplifier would work for before the batteries need to be changed. Some options are shown in the table below:

Picture	Description	Voltage	Capacity	Estimated life	Max power
	Polymer Lithium Ion Cell	3.7 V	400 mAh	2 days	0.7 W
	Polymer Lithium Ion Cell	3.7 V	1000 mAh	5 days	0.7 W
	2x AAA	3V	1000 mAh	7 days	0.45W
	3x AAA	4.5 V	1000 mAh	4.5 days	1 W
	2X AA	3V	1500mAh	10 days	0.45W
	3x AA	4.5 V	1500 mAh	6 days	1 W
	3x C cell	4.5 V	3000 mAh	13 days	1 W

You will have to decide which of these is most important and select your choice of batteries accordingly:

- Compact case.
- Higher volume.
- Long battery life.

Please note that the estimated battery life has been calculated running the amplifier on standard alkaline batteries at full power, hence the higher power choices have a shorter battery life. Obviously if you don't run your MP3 player at the maximum volume, the batteries will last longer.

Please note that Polymer Lithium Ion cells require a different charger compared to standard rechargeable batteries.



## Mounting the Speaker

To get the best performance from your amplifier, you will need to mount the speaker into an enclosure. If the speaker is left in open air, as the paper cone moves in and out, the air will move around the edge of the speaker, giving it poor performance. Try listening to the difference in audio quality with the speaker in the open air, and then cup your hands around the speaker. It is much better when you stop the air going around the edge of the speaker and force it to be pushed forward.

This is why it's so important to mount the speaker. You will have to let the sound out and can design your own speaker grill, or simply you can use the example shown below.

The speaker grill pattern bellow has been designed for the speaker supplied. The three outer points have been designed as retaining points for holding the speaker in place.

The grill is printed to size and can be used when developing your enclosure design as well as for a template for drilling the holes when you are building your enclosure. The recommended drill size is 6mm, except for the three outer points, which may need to be different depending upon how these are used to secure the speaker.

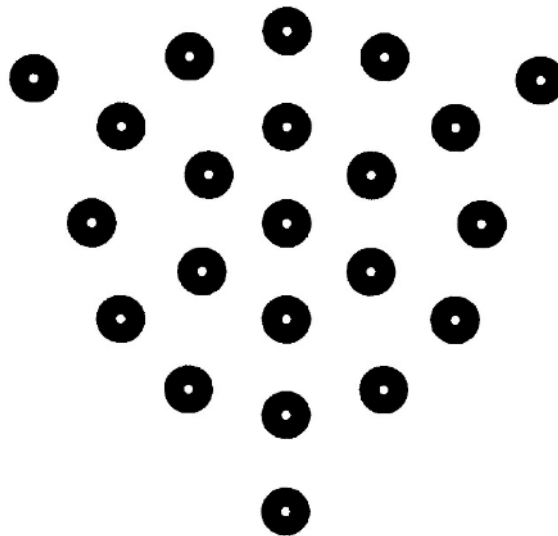

## Design

Develop your ideas to produce a design that meets the requirements listed in the specification.

Name.....

Class.....



## Design Review (group task)

Split into groups of three or four. Take it in turns to review each person's design against the requirements of their specification. Also look to see if you can spot any additional aspects of each design that may cause problems with the final product. This will allow you to ensure that you have a good design and catch any faults early in the design process. Note each point that is made and the reason behind it. Decide if you are going to accept or reject the comment made. Use these points to make improvements to your initial design.

Comment	Reason for comment	Accept or Reject



## Soldering in 8 Steps

1

### INSERT COMPONENT

Place the component into the board, making sure that it goes in the correct way around, and the part sits closely against the board. Bend the legs slightly to secure the part. Place the board so you can access the pads with a soldering iron.

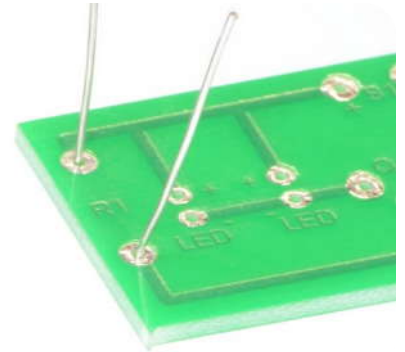

2

### CLEAN SOLDERING IRON

Make sure the soldering iron has warmed up. If necessary use a brass soldering iron cleaner or damp sponge to clean the tip.



3

### PICKUP IRON AND SOLDER

Pick up the Soldering Iron in one hand, and the solder in the other hand.

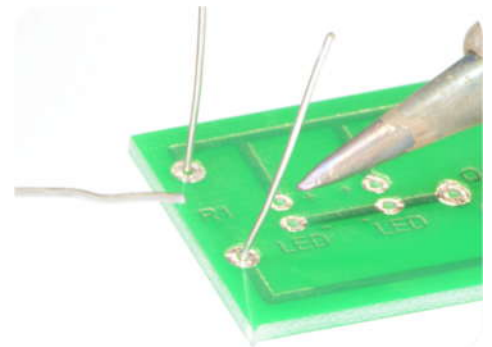

4

### HEAT PAD

Place soldering iron tip on the pad.

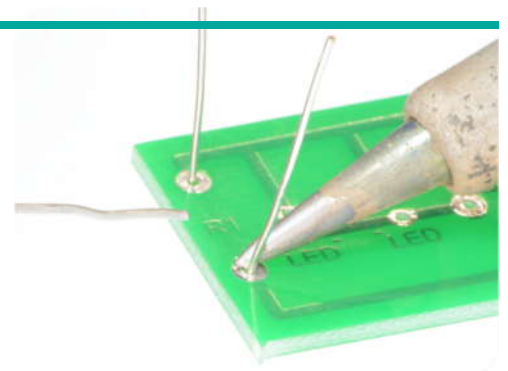

5

## APPLY SOLDER

Feed a small amount of solder into the joint. The solder should melt on the pad and flow around the component leg.

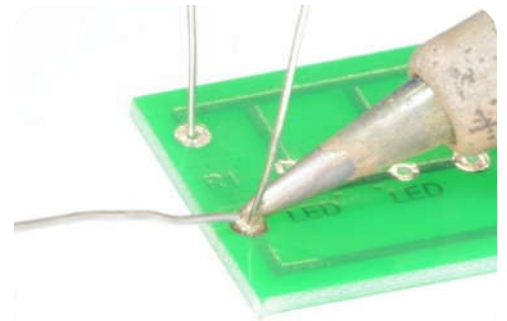

6

## STOP SOLDERING

Remove the solder, and then remove the soldering iron.

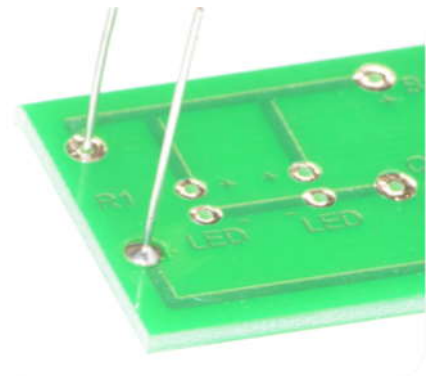

7

## TRIM EXCESS

Leave the joint to cool for a few seconds, then using a pair of cutters trim the excess component lead.

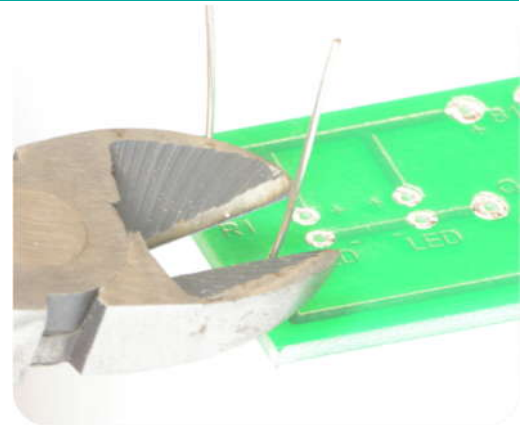

8

## REPEAT

Repeat this process for each solder joint required.

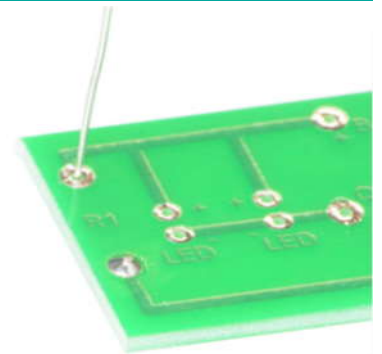



## Resistor Values

A resistor is a device that opposes the flow of electrical current. The bigger the value of a resistor, the more it opposes the current flow. The value of a resistor is given in  $\Omega$  (ohms) and is often referred to as its 'resistance'.

### Identifying resistor values

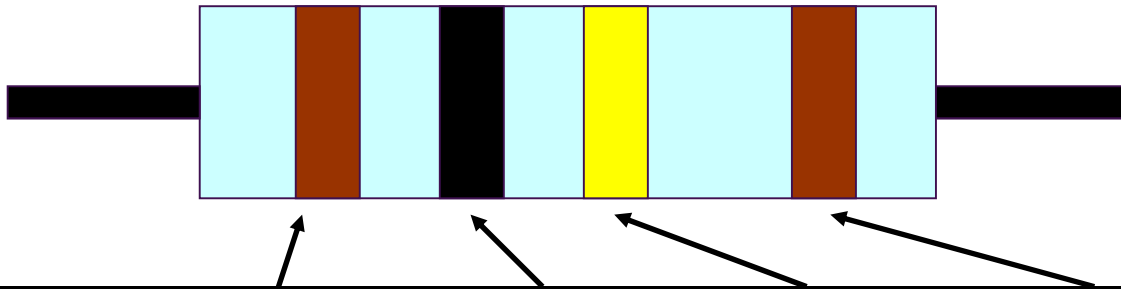

Band Colour	1st Band	2nd Band	Multiplier x	Tolerance
Silver			$\div 100$	10%
Gold			$\div 10$	5%
Black	0	0	1	
Brown	1	1	10	1%
Red	2	2	100	2%
Orange	3	3	1000	
Yellow	4	4	10,000	
Green	5	5	100,000	
Blue	6	6	1,000,000	
Violet	7	7		
Grey	8	8		
White	9	9		

Example: Band 1 = Red, Band 2 = Violet, Band 3 = Orange, Band 4 = Gold

The value of this resistor would be:

$$\begin{aligned}
 &2 \text{ (Red)} \ 7 \text{ (Violet)} \times 1,000 \text{ (Orange)} &&= 27 \times 1,000 \\
 &&&= \mathbf{27,000} \text{ with a 5\% tolerance (gold)} \\
 &&&= \mathbf{27K\Omega}
 \end{aligned}$$

#### Too many zeros?

Kilo ohms and mega ohms can be used:

$$1,000\Omega = 1K$$

$$1,000K = 1M$$

### Resistor identification task

Calculate the resistor values given by the bands shown below. The tolerance band has been ignored.

1st Band	2nd Band	Multiplier x	Value
Brown	Black	Yellow	
Green	Blue	Brown	
Brown	Grey	Yellow	
Orange	White	Black	



## Calculating resistor markings

Calculate what the colour bands would be for the following resistor values.

Value	1st Band	2nd Band	Multiplier x
180 $\Omega$			
3,900 $\Omega$			
47,000 (47K) $\Omega$			
1,000,000 (1M) $\Omega$			

## What does tolerance mean?

Resistors always have a tolerance but what does this mean? It refers to the accuracy to which it has been manufactured. For example if you were to measure the resistance of a gold tolerance resistor you can guarantee that the value measured will be within 5% of its stated value. Tolerances are important if the accuracy of a resistors value is critical to a design's performance.

## Preferred values

There are a number of different ranges of values for resistors. Two of the most popular are the E12 and E24. They take into account the manufacturing tolerance and are chosen such that there is a minimum overlap between the upper possible value of the first value in the series and the lowest possible value of the next. Hence there are fewer values in the 10% tolerance range.

E-12 resistance tolerance ( $\pm 10\%$ )

10	12	15	18	22	27	33	39	47	56	68	82
----	----	----	----	----	----	----	----	----	----	----	----

E-24 resistance tolerance ( $\pm 5\%$ )

10	11	12	13	15	16	18	20	22	24	27	30
33	36	39	43	47	51	56	62	68	75	82	91



## Capacitor Basics

### What is a capacitor?

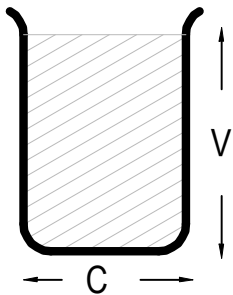

A capacitor is a component that can store electrical charge (electricity). In many ways, it is like a rechargeable battery.

A good way to imagine a capacitor is as a bucket, where the size of the base of the bucket is equivalent to the capacitance ( $C$ ) of the capacitor and the height of the bucket is equal to its voltage rating ( $V$ ).

The amount that the bucket can hold is equal to the size of its base multiplied by its height, as shown by the shaded area.

### Filling a capacitor with charge

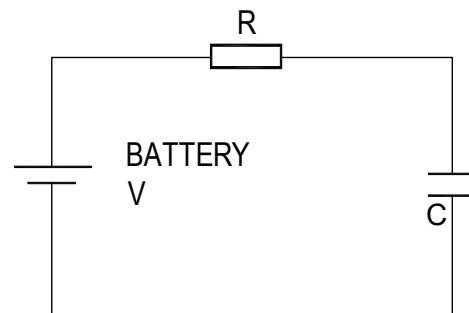
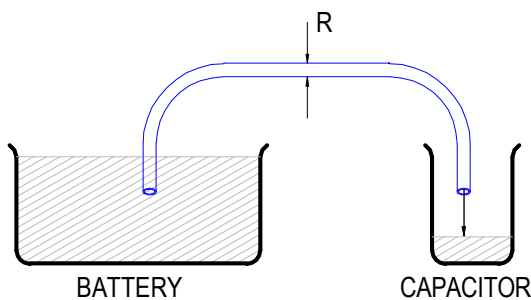

When a capacitor is connected to an item such as a battery, charge will flow from the battery into it. Therefore the capacitor will begin to fill up. The flow of water in the picture above left is the equivalent of how the electrical charge will flow in the circuit shown on the right.

The speed at which any given capacitor will fill depends on the resistance ( $R$ ) through which the charge will have to flow to get to the capacitor. You can imagine this resistance as the size of the pipe through which the charge has to flow. The larger the resistance, the smaller the pipe and the longer it will take for the capacitor to fill.

### Emptying (discharging) a capacitor

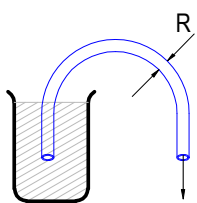

Once a capacitor has been filled with an amount of charge, it will retain this charge until it is connected to something into which this charge can flow.

The speed at which any given capacitor will lose its charge will, like when charging, depend on the resistance ( $R$ ) of the item to which it is connected. The larger the resistance, the smaller the pipe and the longer it will take for the capacitor to empty.

### Maximum working voltage

Capacitors also have a maximum working voltage that should not be exceeded. This will be printed on the capacitor or can be found in the catalogue the part came from. You can see that the capacitor on the right is printed with a 10V maximum working voltage.

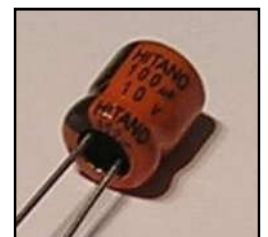

## Ceramic Disc Capacitors

### Values

The value of a capacitor is measured in Farads, though a 1 Farad capacitor would be very big. Therefore we tend to use milli Farads (mF), micro Farads ( $\mu\text{F}$ ), nano Farads (nF) and pico Farads (pF). A  $\mu\text{F}$  is a millionth of a Farad,  $1\mu\text{F} = 1000\text{ nF}$  and  $1\text{nF} = 1000\text{ pF}$ .

1F	= 1,000mF
1F	= 1,000,000 $\mu\text{F}$
1F	= 1,000,000,000nF
1F	= 1,000,000,000,000pF

The larger electrolytic capacitors tend to have the value printed on the side of them along with a black band showing the negative lead of the capacitor.

Other capacitors, such as the ceramic disc capacitor shown on the right, use a code. They are often smaller and may not have enough space to print the value in full, hence the use of the 3-digit code. The first 2 digits are the first part of the number and the third digit gives the number of zeros to give its value in pF.



Example:  $104 = 10 + 0000$  (4 zero's) = **100,000 pF** (which is also  $0.1\ \mu\text{F}$ )

Work out what value the four capacitors are in the table below.

Printing on capacitor	Two digit start	Number of zero's	Value in pF
222			
103			
333			
473			



## Instruction Manual

Your amplifier is going to be supplied with some instructions. Identify four points that must be included in the instructions and give a reason why.

Point to include:

Reason:

Point to include:

Reason:

Point to include:

Reason:

Point to include:

Reason:



## Evaluation

It is always important to evaluate your design once it is complete. This will ensure that it has met all of the requirements defined in the specification. In turn, this should ensure that the design fulfils the design brief.

Check that your design meets all of the points listed in your specification.

Show your product to another person (in real life this person should be the kind of person at which the product is aimed). Get them to identify aspects of the design, which parts they like and aspects that they feel could be improved.

Good aspects of the design	Areas that could be improved

## Improvements

Every product on the market is constantly subject to redesign and improvement. What aspects of your design do you feel you could improve? List the aspects that could be improved and where possible, draw a sketch showing the changes that you would make.



## Packaging Design

If your product was to be sold in a high street electrical retailer, what requirements would the packaging have? List these giving the reason for the requirement.

Requirement	Reason

Develop a packaging design for your product that meets these requirements. Use additional pages if required.







# ESSENTIAL INFORMATION

BUILD INSTRUCTIONS  
CHECKING YOUR PCB & FAULT-FINDING  
MECHANICAL DETAILS  
HOW THE KIT WORKS

CREATE YOUR OWN SPEAKER DOCK WITH THIS

## MONO AMPLIFIER KIT

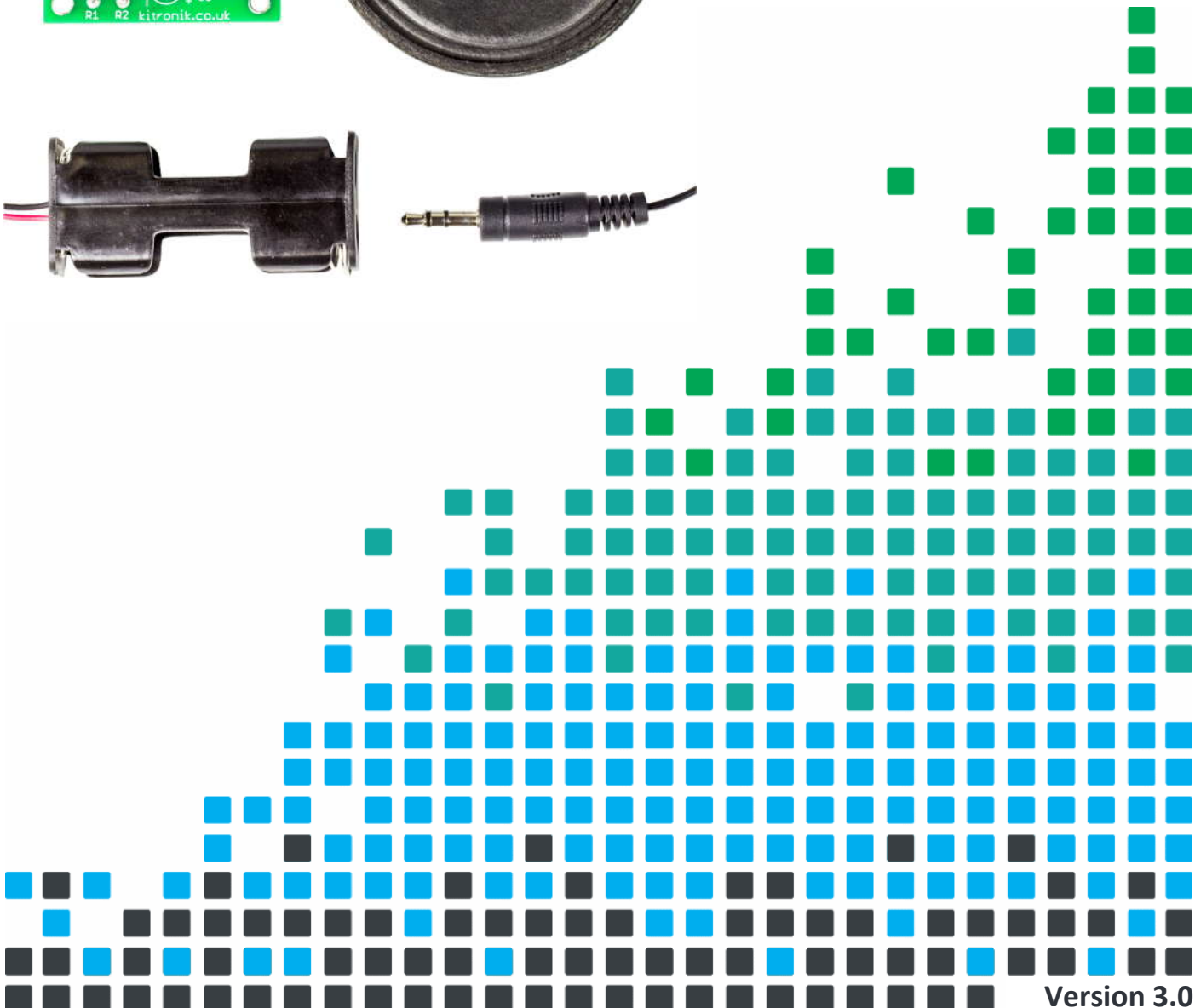
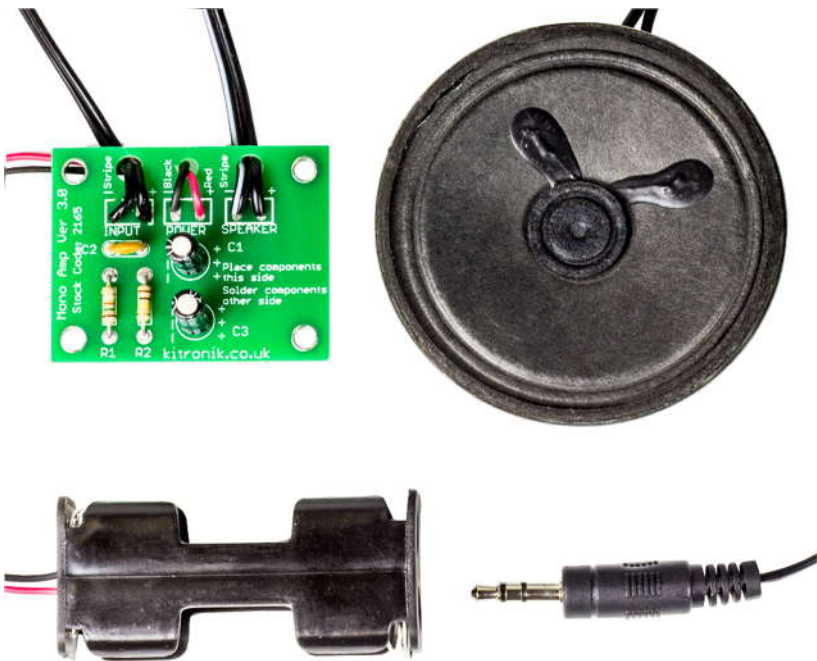

## Build Instructions

Before you start, take a look at the Printed Circuit Board (PCB). The components go in the side with the writing on and the solder goes on the side with the tracks and silver pads. If the PCB is pre-built, proceed to step 4.

### 1 PLACE RESISTORS

Start with the two resistors:  
The text on the PCB shows where R1, R2 go.  
Ensure that you put the resistors in the right place.

PCB Ref	Value	Colour Bands
R1	15k	Brown, Green, Orange
R2	100k	Brown, Black, Yellow



### 2 SOLDER THE CERAMIC DISC CAPACITORS

There is one ceramic disc capacitor which should be soldered in to C2 on the PCB. The capacitor should be marked '104'. It does not matter which way around it goes



### 3 SOLDER THE ELECTROLYTIC CAPACITORS

The other two capacitors are electrolytic capacitors, they are both marked 1uF. Place these two capacitors in to the board where it is labelled C1 and C3. Make sure the device is the correct way around. The capacitors have a '-' sign marked on them which should match the same sign on the PCB.

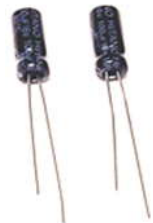

### 4 CONNECT THE WIRES

The 3 connections to your amplifier PCB need to go through the strain relief holes as shown in the picture. Start with the connection labelled 'Speaker'. The kit is supplied with 1/2 a metre of twin cable with a 3.5mm Jack connector on one end. This cable will be used to connect both the speaker and the MP3 player. You will need to cut a length from the end that does not have the Jack connector on, which will be used to connect the speaker. Make sure that you leave enough cable so that you have a long enough lead to connect your MP3 player!



# Mono Amplifier Essentials

[www.kitronik.co.uk/2165](http://www.kitronik.co.uk/2165)



Take the piece of wire that you have cut off and strip the ends of the wire. Connect one end to the two terminals on the speaker and the other end to the board connection marked 'Speaker'. Whilst it doesn't matter which way around the speaker connections go you may wish to connect the stripe to the pad on the board marked stripe and at the speaker end connect the stripe to the '-' terminal.

The middle connection is for the power. The AA battery case (shown left) should be attached to the power connection. Connect the red wire to '+' and the black wire to '-'.



The final connection is the audio input. Strip the insulation off the other end of the remaining cable that has the Jack plug on. Run some solder into the wire and trim the wire so that only 2 or 3mm of bare wire is left. Solder these wires into the board where it is labelled 'Input'. The side of the wire with the stripe should be connected to the pad labelled stripe.

## Checking Your Amplifier PCB

Carefully check the following before you insert the batteries:

**Audio equipment may become damaged if connected to an incorrectly built amplifier.**

**Check the bottom of the board to ensure that:**

- All holes (except the 4 large (3.3 mm) holes in the corners) are filled with the lead of a component.
- All these leads are soldered.
- Leads next to each other are not soldered together.

**Check the top of the board to ensure that:**

- The three wires are connected to the right place.
- The '-' on the capacitors match the same marks on the PCB.
- The colour bands on R1 are Brown, Green, Orange & R2 are Brown, Black, Yellow.
- The battery clip red and black wires match the red & black text on the PCB.



## Adding an On / Off Switch

If you wish to add a [power switch](#), don't solder both ends of the battery clip directly into the board, instead:

1

Solder the black wire '-' of the battery clip to the PCB.

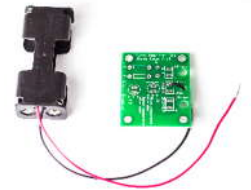

2

Solder the red wire '+' of the battery clip to the on / off switch.

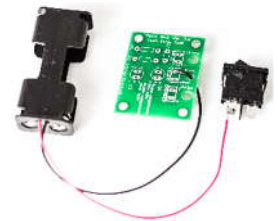

3

Using a piece of red wire, solder the remaining terminal on the on / off switch to the remaining power connection on the PCB.

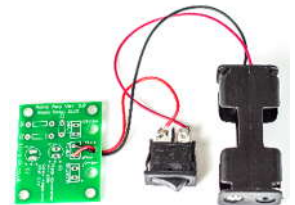

## Fault finding flow chart

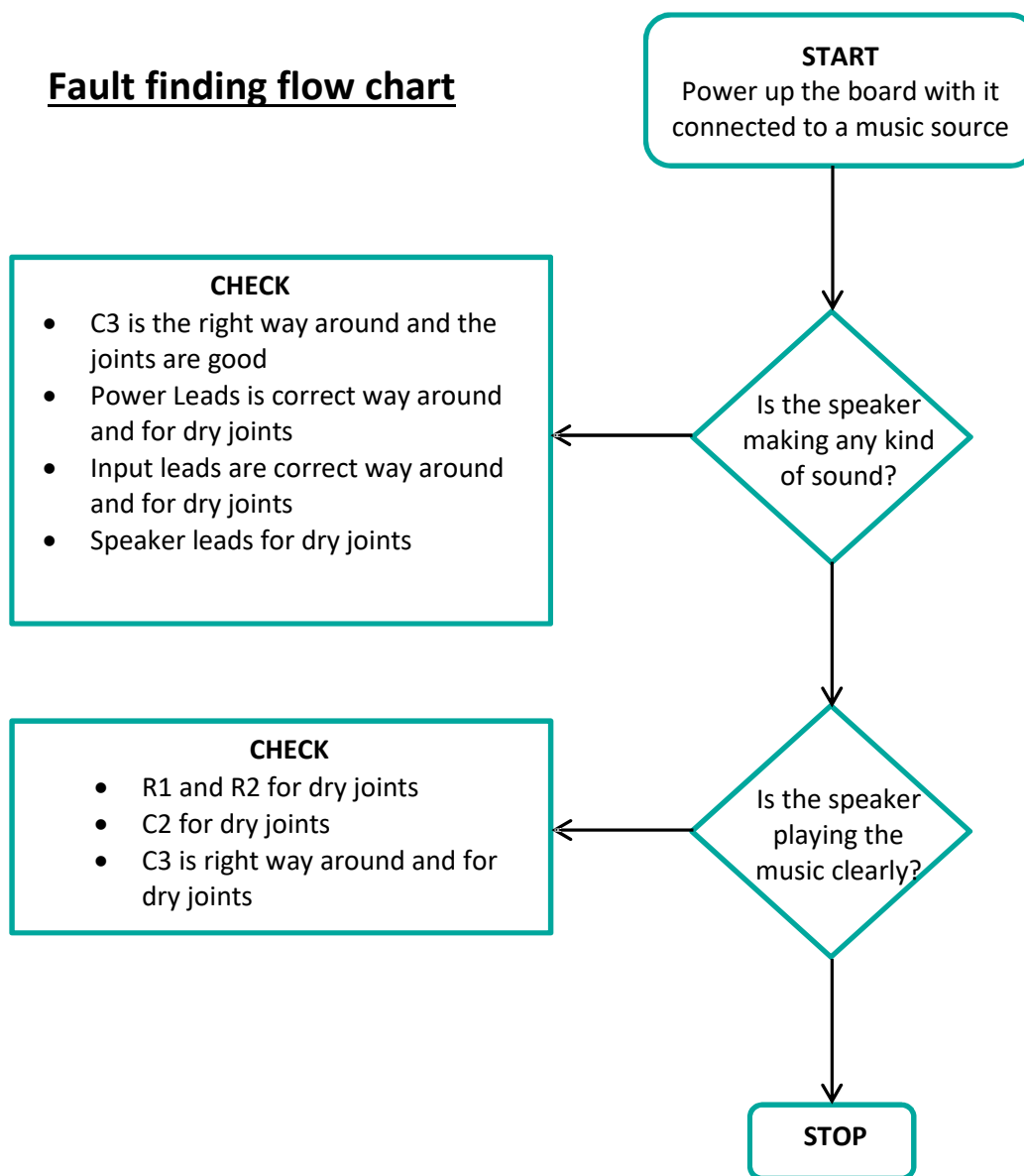

## Designing the Enclosure

When you design the enclosure, you will need to consider:

- The size of the PCB (below left, height including components = 15mm)
- How big the batteries are.
- How to mount the speaker (below right).
- How to allow the audio cable out of the box.
- Are you making the amplifier for a particular MP3 player, if so should the MP3 player go in the box?

These technical drawings of the amplifier PCB and speaker should help you plan this.

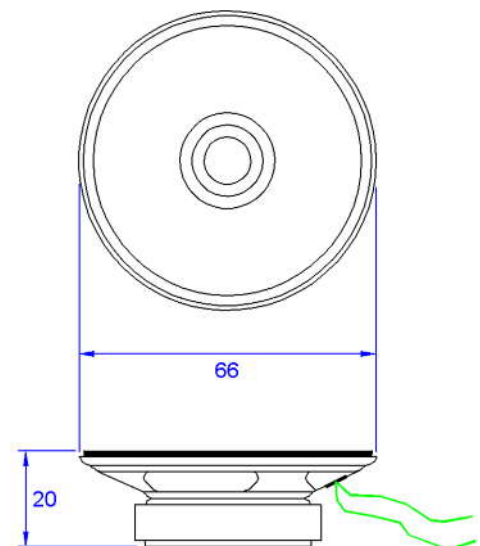
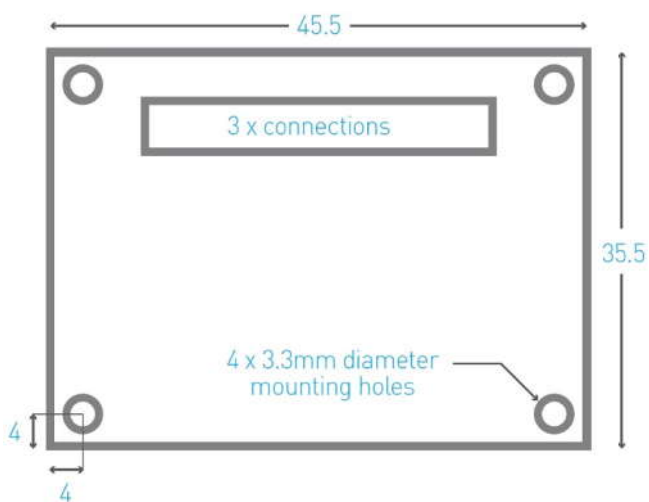

All dimensions in mm  
x4 holes 3.3mm diameter

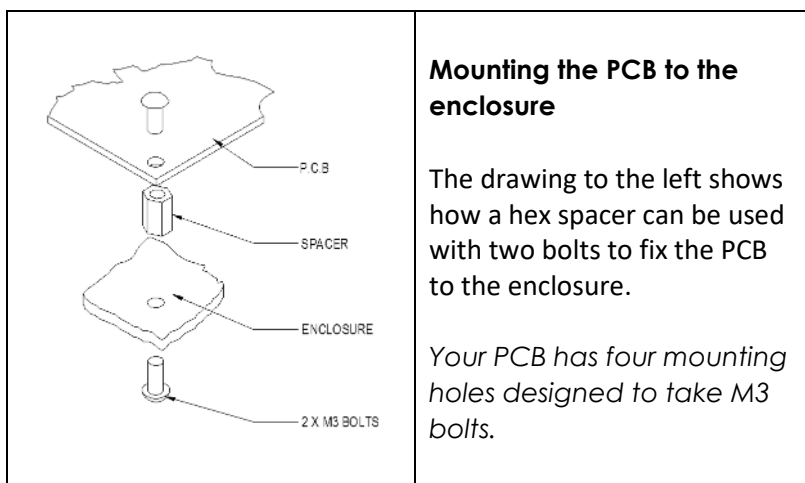

## How the Amplifier Works

At the centre of the circuit is an audio amplifier Integrated Circuit or IC. Inside the IC are lots of transistors, which are connected together to allow the small input signal to be amplified into a more powerful output that can drive a speaker.

All amplifiers need to use feedback to ensure the amount of gain stays the same. This allows the output to be an exact copy of the input just bigger. The gain is the number of times bigger the output is compared to the input, so if an amplifier has a gain of 10 and there is 1 volt on the input there will be 10 volts on the output. Before looking at how the feedback works, we first need to understand how a standard amplifier works. An operational amplifier has two inputs these are called the inverting (-) and non-inverting (+) inputs. The output of the operational amplifier is the voltage on the non-inverting input less the voltage on the inverting input multiplied by the amplifiers gain. In theory an operational amplifier has unlimited gain so if the non-inverting input is a fraction higher than the inverting input (there is more + than -) the output will go up to the supply voltage. Change the inputs around and the output will go to zero volts. In this format the operational amplifier is acting as a comparator, it compares the two inputs and changes the output accordingly.

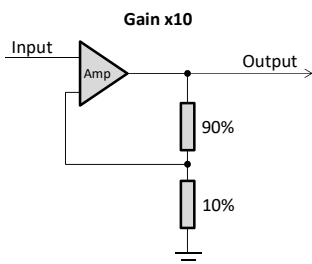

With an infinite gain the amplifier is no good to amplify audio, which is where the feedback comes in. By making one of the inputs a percentage of the output the gain can be fixed, which allows the output to be a copy of the input but bigger. Now when the two inputs are compared and the output is adjusted, instead of it going up or down until it reaches 0 volts or V+, it stops at the point when the two inputs match and the output is at the required voltage.

Looking at the circuit diagram for the audio amplifier, R2 is the feedback resistor. For a standard (single ended) amplifier the gain would be calculated by  $R2 / R1$ , giving a gain of  $100k / 15k = 6.66$ . However this amplifier is a differential amplifier, which means the second output is an inverted version of the first output (see diagram below) and results in twice the gain, so the overall gain is 13.33

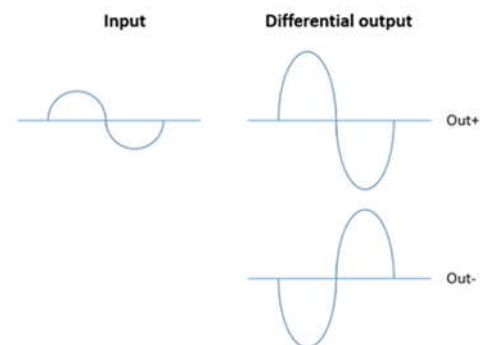
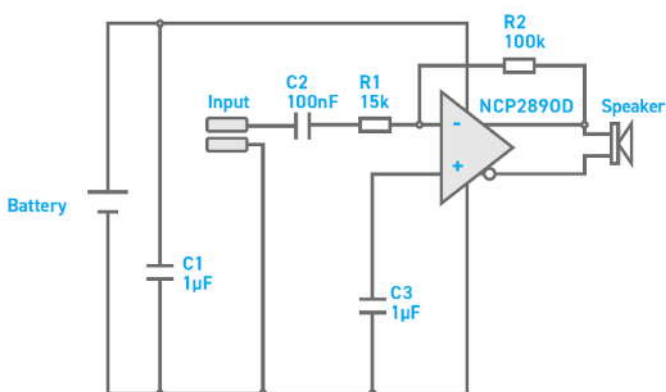

The rest of the components are needed as follows:

C1 is connected across the supply to make sure that it remains stable.

C2 forms a high pass filter, with R1, to block DC voltages which could damage the amplifier.

C3 provides a controlled start to the amplifier, to prevent speaker damage.





## Online Information

Two sets of information can be downloaded from the product page where the kit can also be reordered from. The 'Essential Information' contains all of the information that you need to get started with the kit and the 'Teaching Resources' contains more information on soldering, components used in the kit, educational schemes of work and so on and also includes the essentials. Download from:

[www.kitronik.co.uk/2165](http://www.kitronik.co.uk/2165)



This kit is designed and manufactured in the UK by Kitronik

---

**Telephone:** +44 (0) 845 8380781

**Sales email:** [sales@kitronik.co.uk](mailto:sales@kitronik.co.uk)

**Tech support email:** [support@kitronik.co.uk](mailto:support@kitronik.co.uk)

**Web:** [www.kitronik.co.uk](http://www.kitronik.co.uk)



[www.kitronik.co.uk/twitter](http://www.kitronik.co.uk/twitter)



[www.kitronik.co.uk/facebook](http://www.kitronik.co.uk/facebook)



[www.kitronik.co.uk/youtube](http://www.kitronik.co.uk/youtube)



[www.kitronik.co.uk/google](http://www.kitronik.co.uk/google)

---

Every effort has been made to ensure that these notes are correct, however Kitronik accept no responsibility for issues arising from errors / omissions in the notes.

© Kitronik Ltd - Any unauthorised copying / duplication of this booklet or part thereof for purposes except for use with Kitronik project kits is not allowed without Kitronik's prior consent.

---

