

CONTACT CONFIGURATION
TIMING (BBM) NON-SHORTING

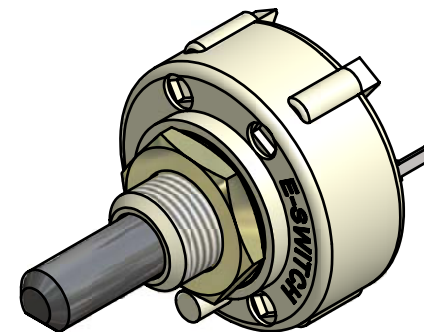

ISOMETRIC

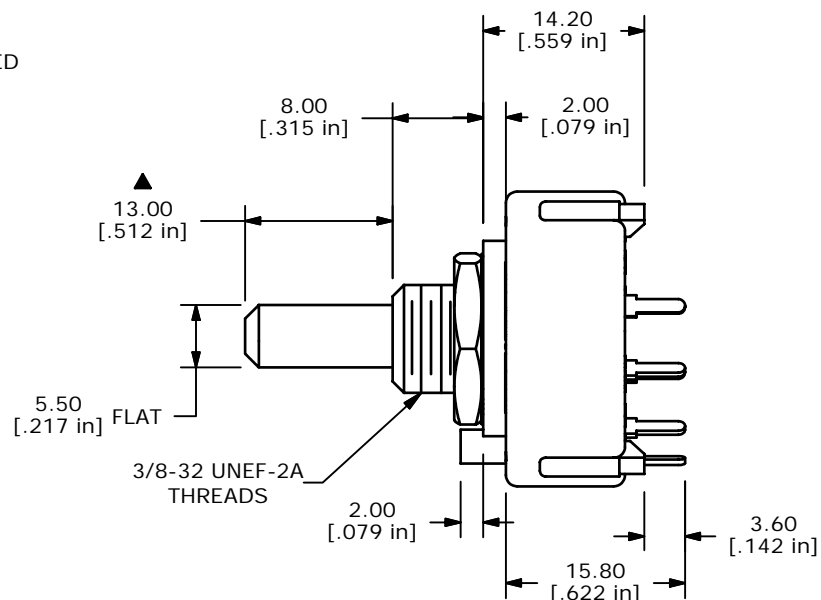
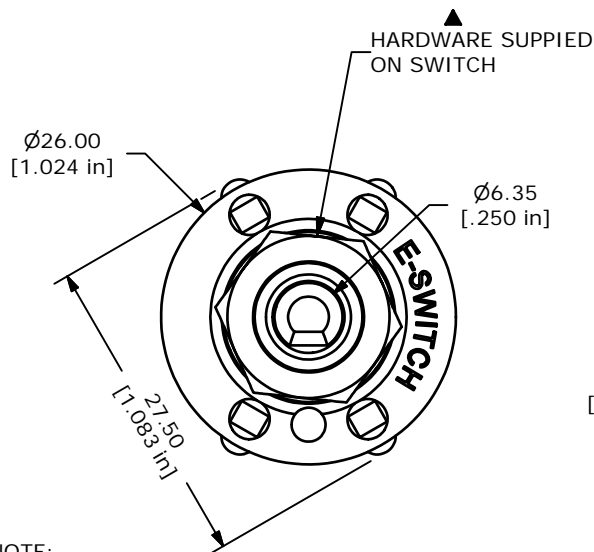
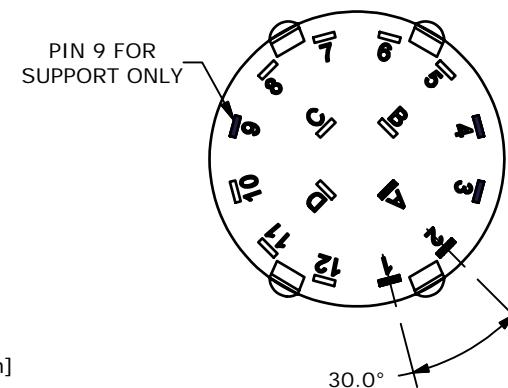

- NOTE:
1. ALL DIMENSIONS IN MM[INCH].
 2. GENERAL TOLERANCE: X.X=±0.4
X.XX=±0.25
 3. TERM. NOS. FOR REFERENCE ONLY.
 - ▲ 4. CONTACT MATERIAL: SILVER
 5. CONTACT RATING: 150MILLIAMP, 250VAC/DC
350MILLIAMP, 110VAC/DC
 6. CONTACT RATING (NON-SWITCHING) 5A
 7. OPERATING FORCE 425±100CM/STANDARD
 8. OPERATING TEMP: -30°C TO 85°C
 - ▲ 9. CIRCUIT SP: 4 POSITION 30° INDEX.
 10. DIELECTRIC STRENGTH: 1000V RMS MIN.@ SEA LEVEL.
 - ▲ 11. HARDWARE SUPPLIED ON SWITCH:
LOCKWASHER, HEXNUT, STOP RING
 12. ▲DENOTES CRITICAL PARAMETER.
 13. 2002/95/EC (ROHS) COMPLIANT

E-SWITCH®

TITLE KC14A13.001NPS

A	15918	RELEASED FOR PRODUCTION	4/3/06	PH
REV	PCR NO	DESCRIPTION	DATE	BY

SCALE	DATE	DR	DWG	REV
1.5:1	4/3/2006	PH	G527545	A

THE INFORMATION CONTAINED IN THIS DOCUMENT IS PROPRIETARY TO E-SWITCH AND IS NOT TO BE COPIED OR TRANSFERRED