

Date	SYM	REVISION RECORD	AUTH	DR.	CK.
2/26/10	A	ADDED RAISED PAD TO PCB LAYOUT	T.B.	B.S.	
12/10/10	B	UPDATED NOTE ON PCB LAYOUT FOR CENTER PAD	T.B.	B.S.	
04/20/12	C	ADDED INSULATOR OUTLINE IN PCB LAYOUT	T.B.	B.S.	

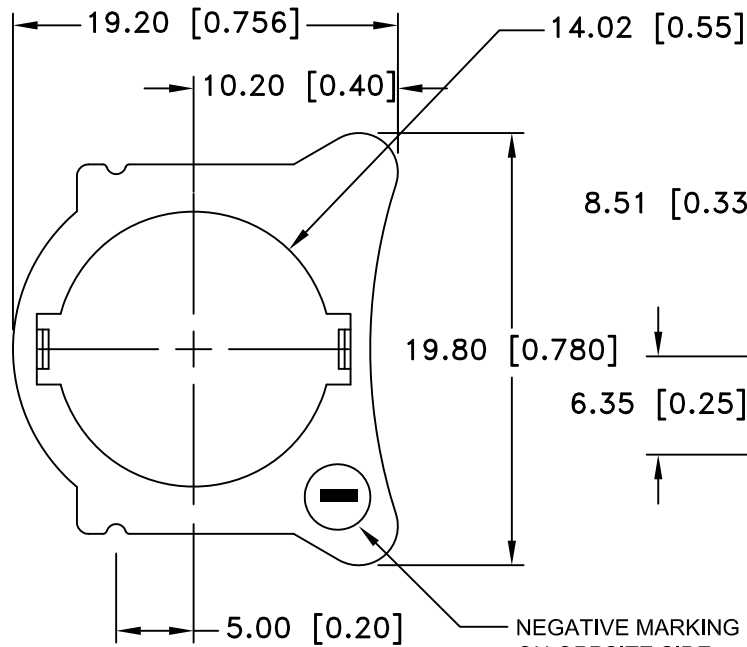

### INSULATOR

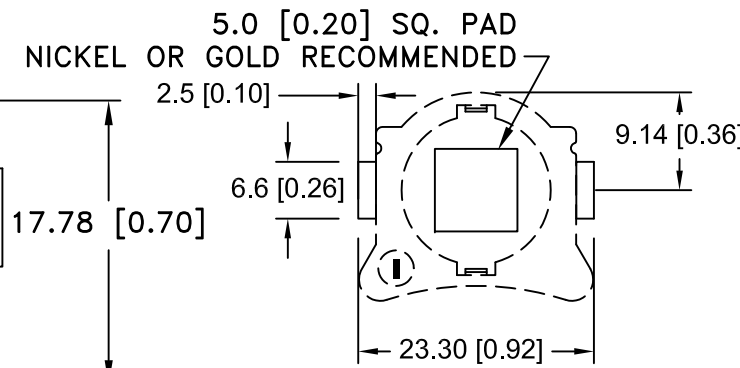
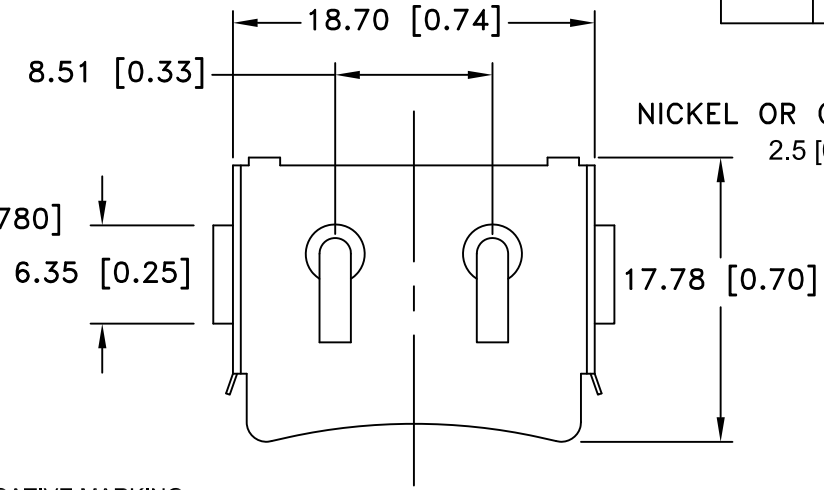
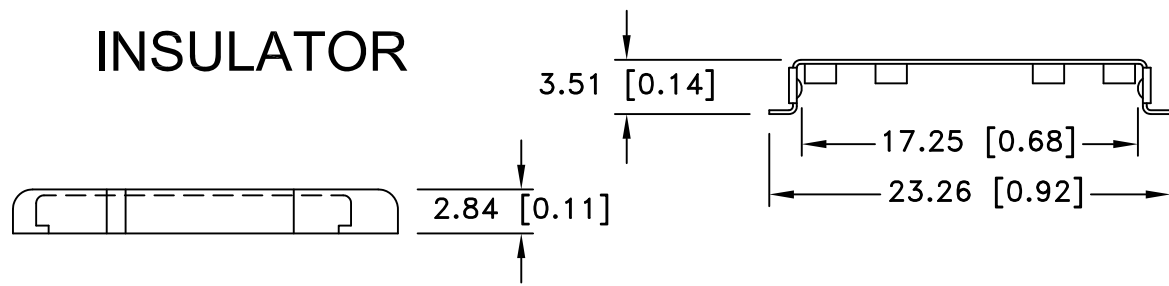

### PCB LAYOUT

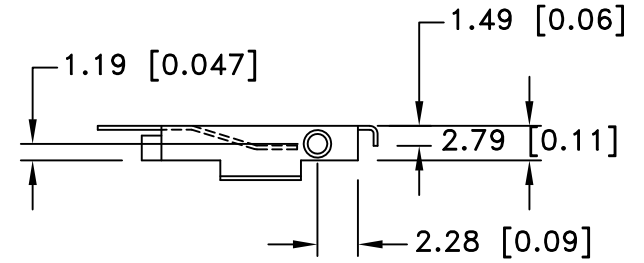

#### SPECIFICATIONS:

- \* Holder material- Polypropylene, AV161 PP, Off White
- \* UL Flamability Rating: UL 94-HB File No. E108370
- \* Contacts : Phosphor Bronze C5191, Nickel Plated 80-150u thickness
- \* Vibration test: 10-50-10 hz swept in 60 seconds  
x,y,z direction: 1 hour each direction
- \* Result: no dislodgement of the cell or damage  
no discontinuity over 10 micro-seconds
- \* Shock test: half sine wave acceleration 150g.  
6 micro-seconds 3 shock pulses each direction per axis,  
total of 18 pulses
- \* Result: no evidence of physical damage
- \* ROHS COMPLIANT

Tolerance (Except as noted)	 <b>Memory Protection Devices, Inc</b> 200 Broad Hollow Road, Farmingdale, New York 11735		
	decimal ±.5 (.020)	Scale	Drawn By B.S. Approved By T.B.
Fractional ± .8 (.030)	Title CR1620 SURFACE MOUNT BATTERY RETAINER WITH INSULATOR		
Angular ± 3°	Date 04/20/12	Drawing Number BHX1-1620-SM	