



NXQ1TXH5

One-chip 5 V Qi wireless transmitter

Rev. 1.1 — 4 March 2016

Product short data sheet

1. General description

The NXQ1TXH5 is a controller and driver IC for a 5 V Qi-certified/compliant low-power wireless charger. It offers a fully integrated solution that includes a 5 V full-bridge power stage, as defined in Wireless Power Consortium (WPC) 5 V Qi standards A5, A11, A12 and A16.

The NXQ1TXH5 uses a dedicated analog ping circuitry to detect devices. With the analog pin circuitry, an extremely low standby (wait state) power consumption is achieved. When a Qi-compliant receiver is placed, the NXQ1TXH5 starts to communicate with it. After the receiver is recognized, it safely initiates wireless power transfer from the transmitter to the receiver, while monitoring for fault conditions such as overheating or interference from metal objects. The device is optimized to operate from a 5 V USB power supply and uses Smart Power Limiting (SPL) to adjust the output power automatically to compensate for power-limited supplies. The device supports Foreign Object Detection (FOD).

LED outputs and a buzzer output are available for the user interface. The LED outputs feature a number of blinking modes. Static Power Reduction (SPR) allows multiple NXQ1TXH5-based transmitters to operate from a single USB power supply by limiting power consumption per device.

The NXQ1TXH5 is available in a 5 mm × 5 mm, 32-pin HVQFN package.

2. Features and benefits

- Single-chip WPC 1.2 transmitter
- Operates from 5 V supply
- Low EMI radiation meeting EN55022 radiated and conducted emission limits
- Very few external components needed, minimizing cost and board space
- Extremely low-power receiver detection circuitry by integrating an analog ping circuit; standby (wait state) power 10 mW (typical)
- Power stage protected against overcurrents and overtemperature
- Dual-channel Amplitude Shift Keying (ASK) demodulation
- Demodulates communication packets from Qi-compliant receivers
- PID regulation for power drive and control
- Internal 1.8 V digital supply generation
- LED (×2) and buzzer outputs
- NTC input for external temperature check and protection
- On-chip thermal protection
- Small HVQFN 32-pin package (5 mm × 5 mm) with 0.5 mm pitch



- FOD with WPC receiver versions 1.2 and 1.1 and for legacy receiver support (Qi version 1.0)
- Peak efficiency > 75 %
- Excellent low power (< 2 W) transfer efficiency. Ideal for charging wearables

3. Applications

- Wireless Power Consortium (WPC) Qi certified/compliant wireless power transmitters
- Wireless charger for (smart)phones, toys, shavers, pads, and other handheld devices
- High-efficiency low-power wireless charger for smartwatches and other wearables

4. Quick reference data

Table 1. Quick reference data

Symbol	Parameter	Conditions	Min	Typ	Max	Unit
V _{DDP}	power supply voltage	on pins VDDP1 and VDDP2	3.4	-	5.25	V
I _{DDP}	power supply current	on pins VDDP1 and VDDP2				
		wait state (average current)	-	2	-	mA
		power transfer state (no load)	-	15	-	mA
		power transfer state (with load)	-	1.5	5 ^[1]	A

[1] The maximum average current is 2 A. However, when removing the receiver, the power stage current protection limits the peak current at 5 A.

5. Ordering information

Table 2. Ordering information

Type number	Package		Version
	Name	Description	
NXQ1TXH5	HVQFN32	plastic thermal enhanced very thin quad flat package; no leads; 32 terminals; body 5 × 5 × 0.85 mm	SOT617-3

5.1 Ordering options

Table 3. Ordering options

Type number	Orderable part number	Package	Packing method	Minimum ordering quantity	Temperature
NXQ1TXH5	NXQ1TXH5/101J	HVQFN32	reel 13" Q1/T1, *standard mark SMD non-dry-pack	6000	T _{amb} = -20 °C to +85 °C

6. Block diagram

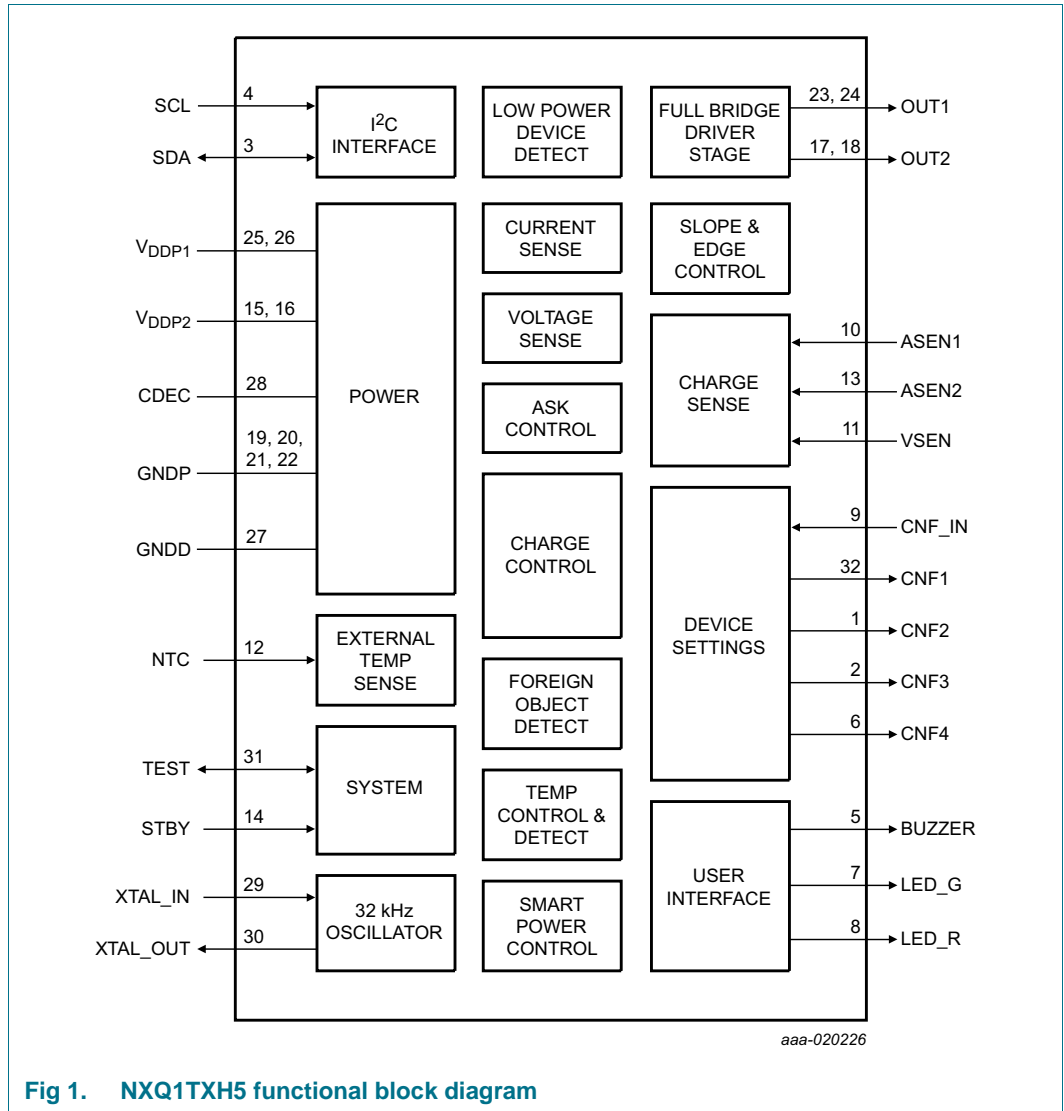
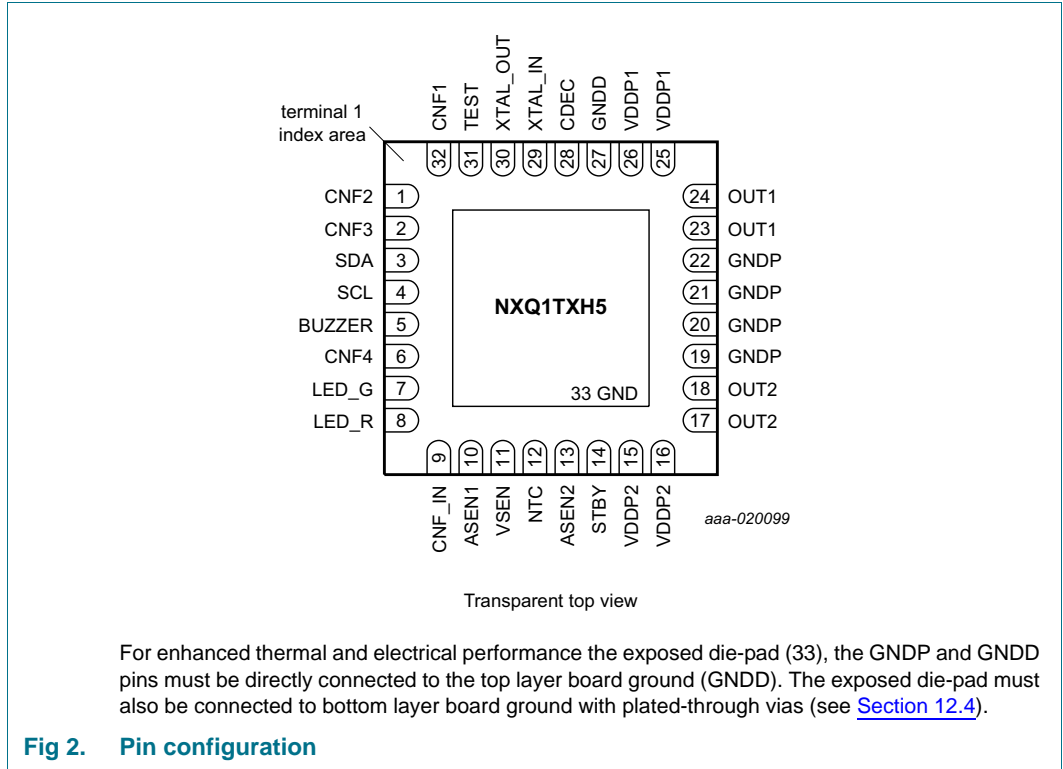

Fig 1. NXQ1TXH5 functional block diagram

7. Pinning information

7.1 Pinning



7.2 Pin description

Table 4. Pin description

Symbol	Pin	Type	Description
CNF2	1	I	configuration output 2 for FOD_E
CNF3	2	I	configuration output 3 for FOD_threshold
SDA	3	I/O	I ² C-bus data input/output; connect to test pad (see Figure 4)
SCL	4	I	I ² C-bus clock input; connect to test pad (see Figure 4)
BUZZER	5	O	buzzer output
CNF4	6	I	configuration output 4 for LED_mode
LED_G	7	O	green LED output
LED_R	8	O	red LED output
CNF_IN	9	I	configuration input
ASEN1	10	I	analog sense input 1
VSEN	11	I	coil voltage sense
NTC	12	I	temperature measurement using NTC
ASEN2	13	I	analog sense input 2
STBY	14	I	standby function; connect to ground when not used
VDDP2	15, 16	P	power supply pin 2

Table 4. Pin description ...continued

Symbol	Pin	Type	Description
OUT2	17, 18	O	transmitter output 2
GNDP	19, 20, 21, 22	P	power ground
OUT1	23, 24	O	transmitter output 1
VDDP1	25, 26	P	power supply pin 1
GNDD	27	P	digital ground
CDEC	28	P	decoupling connection for internal LDO
XTAL_IN	29	I	crystal input
XTAL_OUT	30	O	crystal output
TEST	31	I/O	test pin; connect to ground
CNF1	32	O	configuration output 1 for SPR

8. Functional description

The NXQ1TXH5 is a fully integrated 5 V wireless charger with an internal full-bridge power stage. It efficiently integrates all the functions required to control the power transfer with a Qi-compliant receiver. It can deliver up to 8 W continuous power into the Qi-compliant type A5, A11, A12 or A16 transmitter coil.

[Figure 1](#) shows a block diagram of the NXQ1TXH5. It is operational when a 5 V supply is connected and pin STBY is LOW. The NXQ1TXH5 starts checking for a device on the transmitter base station. When a receiver is detected, power transfer is initiated for the detected receiver.

The power transfer can be monitored via the LEDs and BUZZER outputs.

Additional inputs are provided for configuring the NXQ1TXH5:

- LED mode selection
- Configuring FOD according to the application design and coil/capacitor selection
- Setting the SPR level
- Enabling/disabling SPL

8.1 NXQ1TXH5 operating states

The NXQ1TXH5 supports a number of operating states:

- **Power-on state:**
The NXQ1TXH5 generates a power-on LED blinking sequence after which it is operational (standby = low).
- **Standby state:**
The device is inactive in standby state. The NXQ1TXH5 is in standby state when pin STBY is HIGH. STBY must be connected to ground in standalone applications.
- **Wait state (analog and digital ping):**
The NXQ1TXH5 performs extremely low-power device detection using analog circuitry in analog ping mode. The NXQ1TXH5 performs standard device detection using the DSP in digital ping mode.
- **ID and config state:**
The NXQ1TXH5 communicates with and begins to supply power to a Qi-compliant receiver.
- **Power transfer state:**
The NXQ1TXH5 charges the Qi-compliant receiver in power transfer state.
- **Charged state:**
The NXQ1TXH5 switches to charged state when it receives a 'charge complete' message from the receiver.
- **Fault state:**
The NXQ1TXH5 switches to a fault state when:
 - A receiver error is reported
 - A foreign object is detected between receiver and the transmitter
 - A receiver/transmitter overtemperature condition occurs

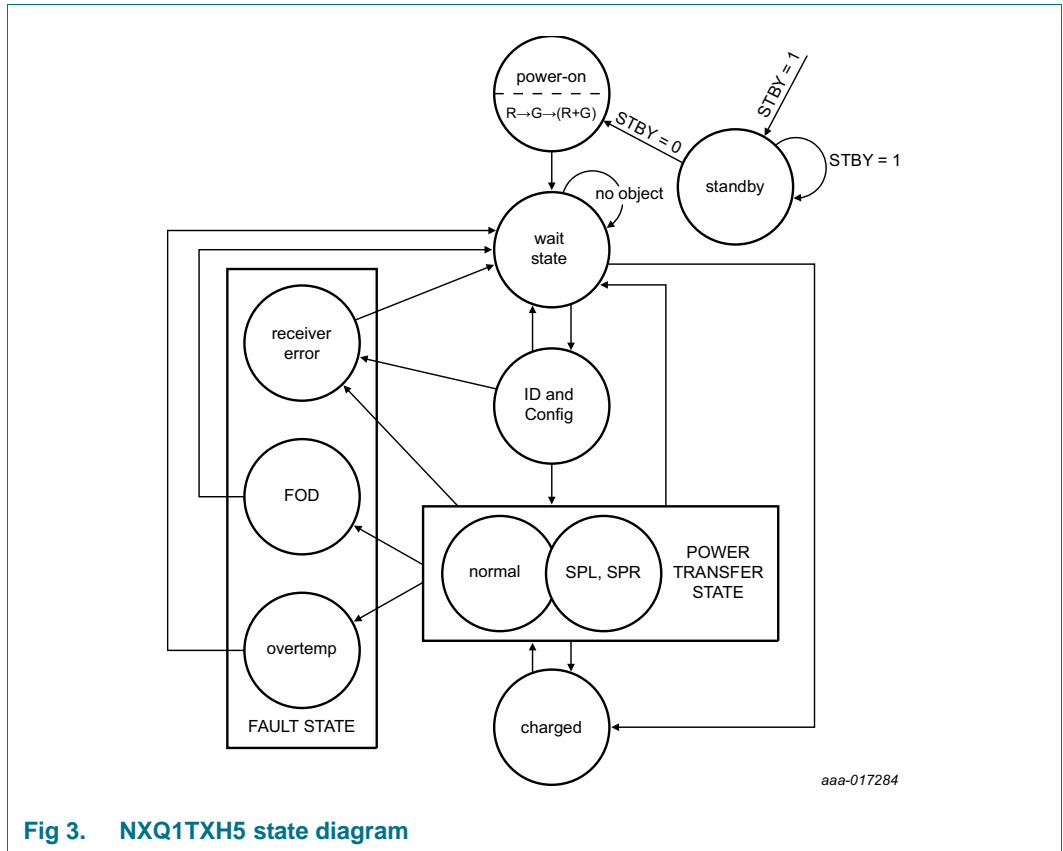

Fig 3. NXQ1TXH5 state diagram

8.2 Protections

The NXQ1TXH5 incorporates three built-in protections.

- Temperature reduction and temperature protection mechanism
- OverCurrent Protection (OCP)
- NTC, which monitors the voltage level on an external NTC network

9. Limiting values

Table 5. Limiting values

In accordance with the Absolute Maximum Rating System (IEC 60134). Voltages are referenced to ground. See Limiting Values disclaimer in [Section 15.3](#).

Symbol	Parameter	Conditions	Min	Max	Unit
V _{DDP}	power supply voltage	on pin VDDP1 and VDDP2	-0.3	+6.0	V
T _j	junction temperature		-	+150	°C
T _{stg}	storage temperature		-55	+150	°C
T _{amb}	ambient temperature		-20	+85	°C
V _{ESD}	electrostatic discharge voltage	according to the Human Body Model (HBM)	-2	+2	kV
		according to the Charge Device Model (CDM)	-500	+500	V

10. Thermal characteristics

Table 6. Thermal characteristics

Symbol	Parameter	Conditions	Typ	Unit
R _{th(j-a)}	thermal resistance from junction to ambient	2-layer application board positioned horizontally in free air; dimensions 45 mm × 45 mm × 0.8 mm; natural convection; copper coverage on each layer > 95 %; copper thickness each layer 70 μm	30	K/W

11. Characteristics

Table 7. DC characteristics

T_{amb} = 25 °C, default settings unless otherwise specified

Symbol	Parameter	Conditions	Min	Typ	Max	Unit
V _{DDP}	power supply voltage	on pin VDDP1 and VDDP2 [1]	3.5	-	5.25	V
I _{DDP}	power supply current	on pins VDDP1 and VDDP2:				
		wait state (peak current) [2]	-	1	-	A
		wait state (average current) [2]	-	2	-	mA
		standby state (STBY HIGH)	-	15	50	μA
		power transfer state (no-load)	-	15	-	mA
		power transfer state (average current with load) [2]	-	-	2	A
	power transfer state (absolute peak current with load)	-	-	5	A	

- [1] The maximum DC V_{DDP} input voltage is 5.25 V. However, at the maximum load, spikes can occur due to high di/dt. With the proper decoupling circuitry and snubbers at the outputs, these spikes must never exceed 7 V (see [Section 12.2](#) and [Section 12.3](#)).
- [2] The current consumption depends on the load impedance of the LC tank connected to the output stage at 175 kHz. Assumed typical value: L = 6.3 μF, 60 mΩ and C = 384 nF.

Table 8. AC characteristics $T_{amb} = 25\text{ }^{\circ}\text{C}$, default settings unless otherwise specified

Symbol	Parameter	Conditions	Min	Typ	Max	Unit
Full-bridge power stage						
f_{sw}	switching frequency	start-up and power transfer states	110	-	205	kHz
$f_{sw(step)}$	switching frequency step size	start-up and power transfer states	-	500	-	Hz
δ	duty cycle	start-up and power transfer states	10	-	50	%
δ_{step}	duty cycle step size	start-up and power transfer states	-	0.1	-	%
pin STBY						
V_{IH}	HIGH-level input voltage	standby state	1.2	-	V_{DDP}	V
V_{IL}	LOW-level input voltage	operating state	-	-	0.6	V
pins CNF_IN, ASEN1, ASEN2, VSEN, and NTC						
V_I	input voltage	operating range	[1] 0	-	1.5	V
LED_G, LED_R and CNF1, CNF2, CNF3, and CNF4 outputs						
V_O	output voltage	set externally	400	-	V_{DDP}	mV
I_{load}	load current	open-drain output	[2] -	-	20	mA
BUZZER output						
V_O	output voltage	set externally	400	-	V_{DDP}	mV
I_{load}	load current	open-drain output	[2] -	-	20	mA
I²C pins: SCL and SDA						
V_{IH}	HIGH-level input voltage		1	-	3.6	V
V_{IL}	LOW-level input voltage		-	-	0.6	V
oscillator: pins XTAL_IN and XTAL_OUT						
V_I	input voltage		-	-	1.8	V
external crystal requirements						
f_{nom}	nominal frequency		32	32.768	33.5	kHz
D_L	drive level		-	-	1	μW
C_L	load capacitance		[3] 8	12	14	pF

[1] The nominal operating range is from 0 V to 1.5 V. However, any level between 1.5 V and V_{DDP} has the same effect (as 1.5 V).

[2] The output voltage at maximum load current is guaranteed not to exceed 400 mV.

[3] The load capacitors are embedded in the NXQ1TXH5.

12. Application information

12.1 Crystal oscillator

The NXQ1TXH5 uses an external low-cost 32.768 kHz crystal, with a 1 % accuracy. The crystal should support a load capacitance of ≈ 12 pF (the load capacitance is embedded in the NXQ1TXH5). Do not connect the crystal to the NXQ1TXH5 using vias, but directly on the top layer of the PCB. If possible, shield the crystal by connecting the casing to ground. The crystal is connected to the oscillator input pin (XTAL_IN) via a 2.2 pF series capacitor.

12.2 Supply decoupling

Effective supply decoupling is required. The decoupling capacitors must be chosen such that the effective capacitance is at least 10 μ F at a DC bias voltage of 5.5 V. The frequency must be 205 kHz for each supply pin. X5R capacitors of 22 μ F normally fulfill this requirement. To prevent spikes that are too high on the VDDP pins and to improve HF behavior and reduce EMI, use smaller (10 nF) high-quality capacitors. These capacitors must be mounted as close as possible to the VDDP pins of the NXQ1TXH5 in parallel with the 22 μ F capacitors (see [Figure 4](#)).

12.3 Snubber network

Snubber RC networks are connected to outputs OUT1 and OUT2. Each snubber network consists of a 6.8 nF capacitor in series with a 1 Ω resistor to ground (see [Figure 4](#)). The snubber network must be connected as close as possible to the NXQ1TXH5 OUT1 and OUT2 pins.

12.4 Exposed die-pad ground and thermal connection

For optimal thermal and electrical performance, the device bottom exposed VSS pin (pin 33) MUST be soldered to a PCB solder land under the exposed die-pad. To have good electrical contact and thermal flow from the device to the bottom copper layer, the PCB solder pad under the device MUST be connected with plated-through vias to the copper bottom layer of the PCB. In this way, the PCB bottom copper layer can provide heat sinking for the device dissipation.

In the NXQ1TXH5 application note examples are provided for recommended layouts with good thermal and electrical performance.

12.5 Support interface

For NXP Semiconductors support purposes, connecting interface wires must be made possible to tune the FOD resistors and to check DSP operation. To connect the interface wires, the NXQ1TXH5 I²C interface pins (pins 3 and 4) must be made available on the PCB layout as exposed test-pads with minimum 2 mm² solder area. A test pad for ground connection must also be placed close to the I²C test-pad connections. Do not connect pull-up resistors to VDDP for the I²C interface pins. For more advanced debug options for NXP Semiconductors, pins 1, 2, and 32 require the same test options.

12.6 Application diagram

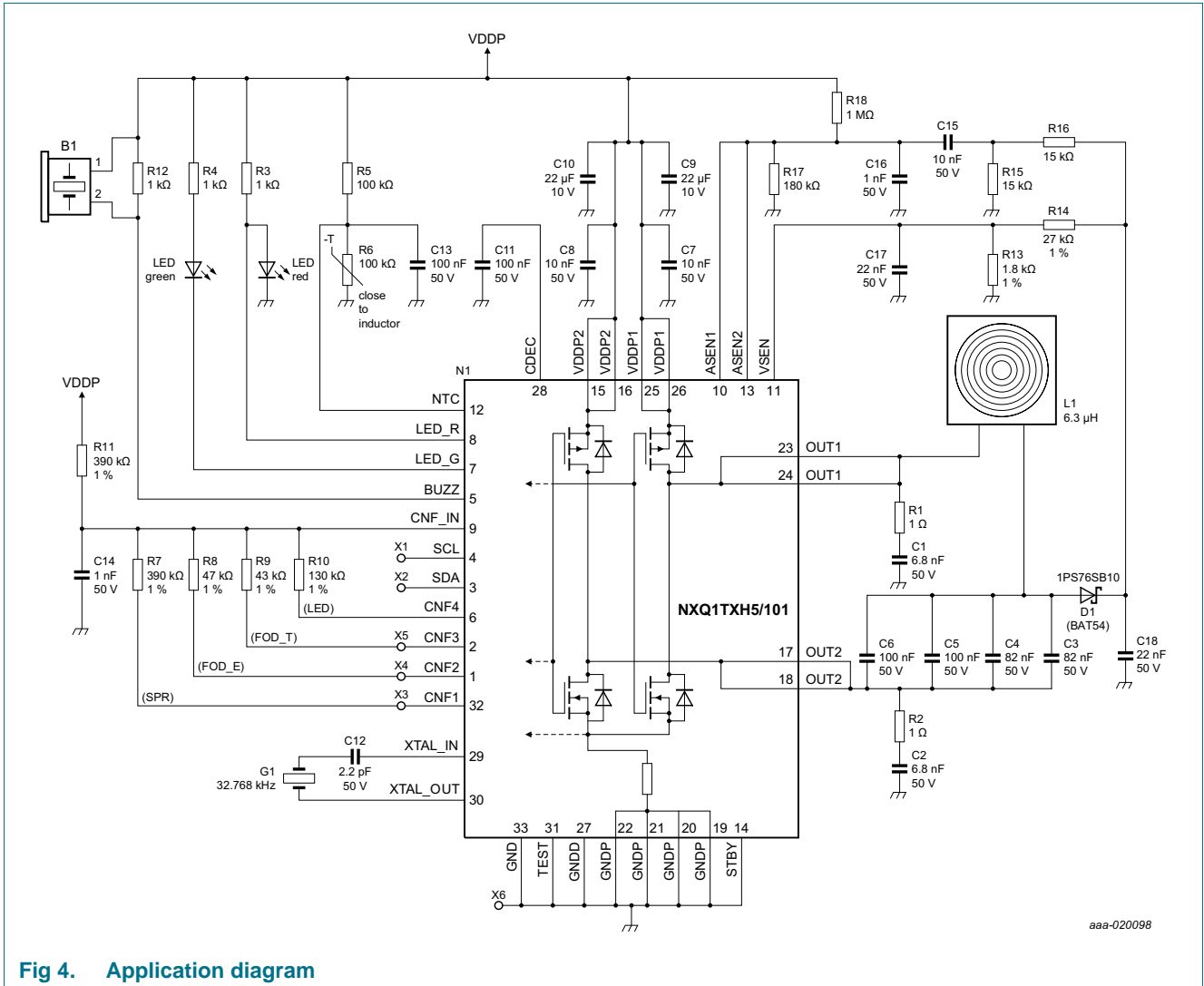

Fig 4. Application diagram

12.7 Efficiency

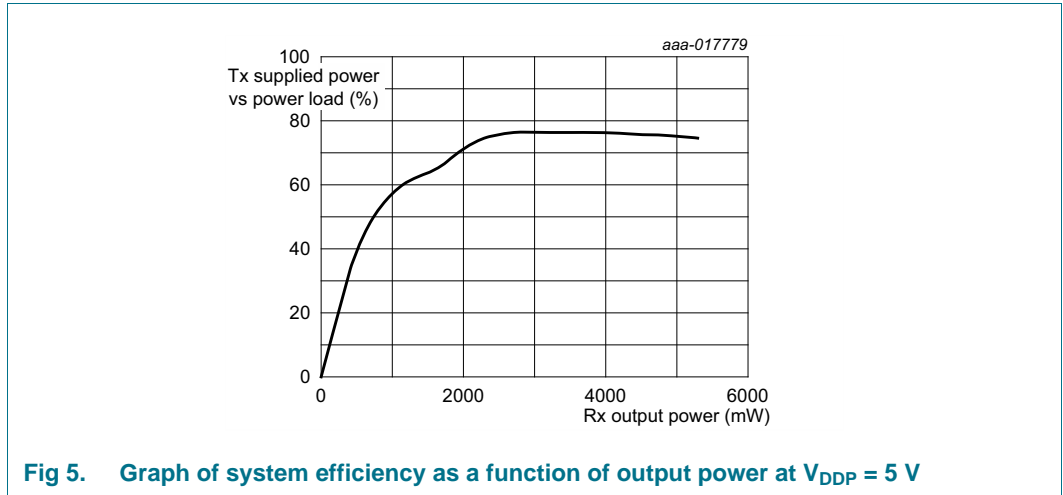

Fig 5. Graph of system efficiency as a function of output power at $V_{DDP} = 5\text{ V}$

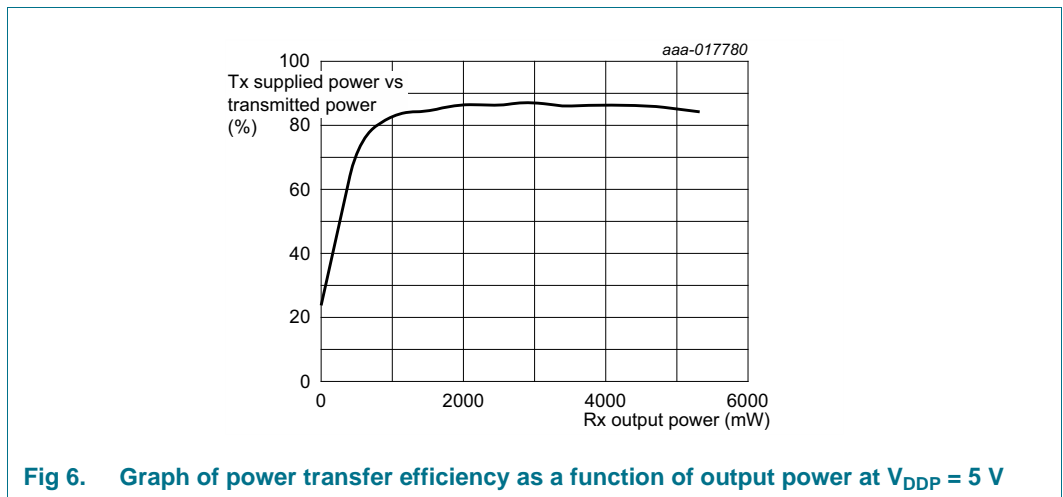

Fig 6. Graph of power transfer efficiency as a function of output power at $V_{DDP} = 5\text{ V}$

Remark: The curves in [Figure 5](#) and [Figure 6](#) are measured on the NXP Semiconductors DB1340 boards with:

- Coil: Elec&Eltek (E&E); Y31-60055F
- Capacitors:
 - 82 nF; 5 %; 50 V; C0G; 1206; Murata; GRM31C5C1H823JA01L
 - 100 nF; 5 %; 50 V; C0G; 1206; TDK; CGA5L2C0G1H104J160AA

13. Package outline

HVQFN32: plastic thermal enhanced very thin quad flat package; no leads; 32 terminals; body 5 x 5 x 0.85 mm

SOT617-3

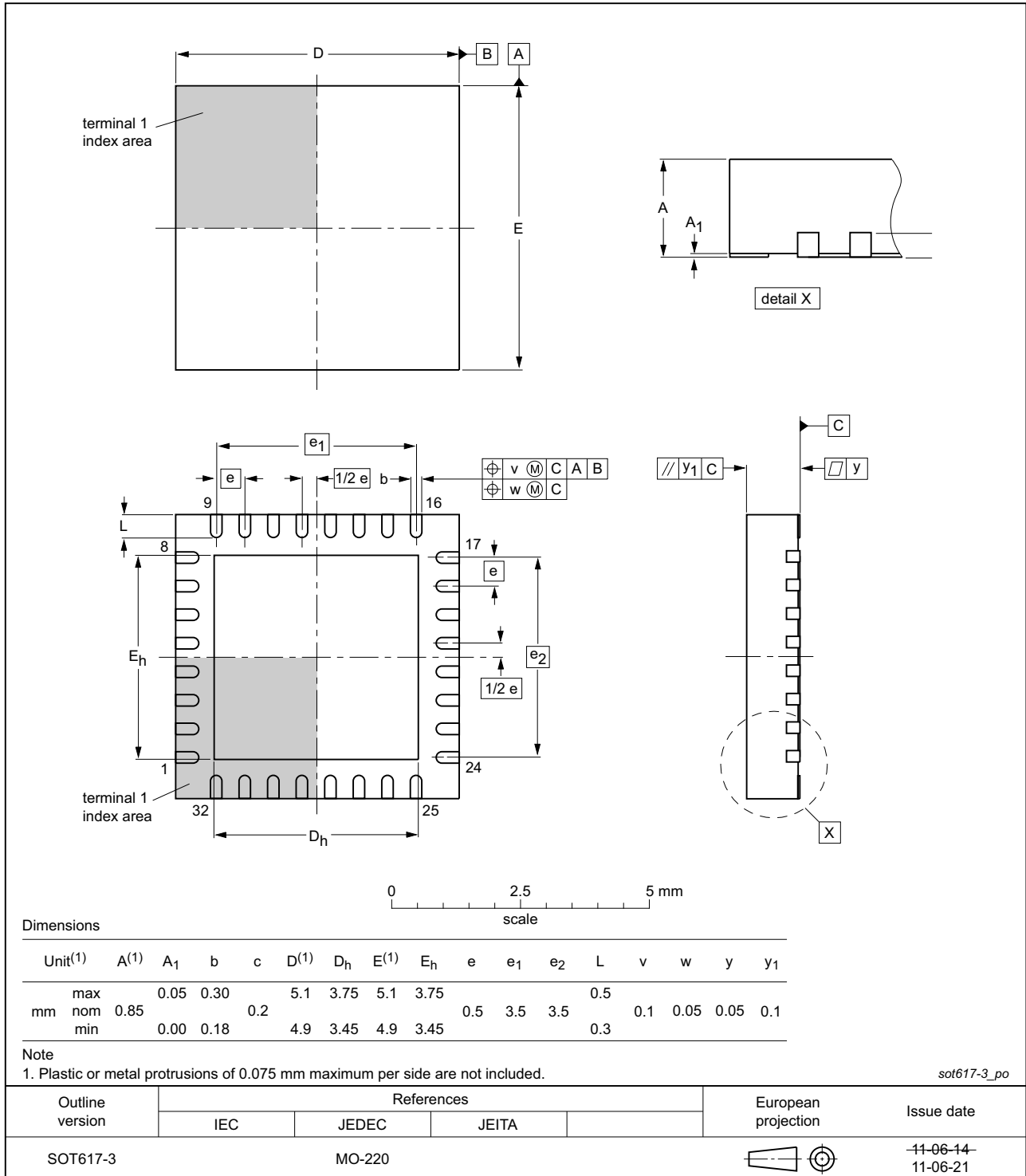

Fig 7. Package outline SOT617-3 (HVQFN32)

14. Revision history

Table 9. Revision history

Document ID	Release date	Data sheet status	Change notice	Supersedes
NXQ1TXH5 v.1.1	20160304	Product short data sheet	-	NXQ1TXH5 v.1
Modifications:	• Table 7 “DC characteristics” has been updated.			
NXQ1TXH5 v.1	20160211	Product short data sheet	-	-

15. Legal information

15.1 Data sheet status

Document status ^{[1][2]}	Product status ^[3]	Definition
Objective [short] data sheet	Development	This document contains data from the objective specification for product development.
Preliminary [short] data sheet	Qualification	This document contains data from the preliminary specification.
Product [short] data sheet	Production	This document contains the product specification.

[1] Please consult the most recently issued document before initiating or completing a design.

[2] The term 'short data sheet' is explained in section "Definitions".

[3] The product status of device(s) described in this document may have changed since this document was published and may differ in case of multiple devices. The latest product status information is available on the Internet at URL <http://www.nxp.com>.

15.2 Definitions

Draft — The document is a draft version only. The content is still under internal review and subject to formal approval, which may result in modifications or additions. NXP Semiconductors does not give any representations or warranties as to the accuracy or completeness of information included herein and shall have no liability for the consequences of use of such information.

Short data sheet — A short data sheet is an extract from a full data sheet with the same product type number(s) and title. A short data sheet is intended for quick reference only and should not be relied upon to contain detailed and full information. For detailed and full information see the relevant full data sheet, which is available on request via the local NXP Semiconductors sales office. In case of any inconsistency or conflict with the short data sheet, the full data sheet shall prevail.

Product specification — The information and data provided in a Product data sheet shall define the specification of the product as agreed between NXP Semiconductors and its customer, unless NXP Semiconductors and customer have explicitly agreed otherwise in writing. In no event however, shall an agreement be valid in which the NXP Semiconductors product is deemed to offer functions and qualities beyond those described in the Product data sheet.

15.3 Disclaimers

Limited warranty and liability — Information in this document is believed to be accurate and reliable. However, NXP Semiconductors does not give any representations or warranties, expressed or implied, as to the accuracy or completeness of such information and shall have no liability for the consequences of use of such information. NXP Semiconductors takes no responsibility for the content in this document if provided by an information source outside of NXP Semiconductors.

In no event shall NXP Semiconductors be liable for any indirect, incidental, punitive, special or consequential damages (including - without limitation - lost profits, lost savings, business interruption, costs related to the removal or replacement of any products or rework charges) whether or not such damages are based on tort (including negligence), warranty, breach of contract or any other legal theory.

Notwithstanding any damages that customer might incur for any reason whatsoever, NXP Semiconductors' aggregate and cumulative liability towards customer for the products described herein shall be limited in accordance with the *Terms and conditions of commercial sale* of NXP Semiconductors.

Right to make changes — NXP Semiconductors reserves the right to make changes to information published in this document, including without limitation specifications and product descriptions, at any time and without notice. This document supersedes and replaces all information supplied prior to the publication hereof.

Suitability for use — NXP Semiconductors products are not designed, authorized or warranted to be suitable for use in life support, life-critical or safety-critical systems or equipment, nor in applications where failure or malfunction of an NXP Semiconductors product can reasonably be expected to result in personal injury, death or severe property or environmental damage. NXP Semiconductors and its suppliers accept no liability for inclusion and/or use of NXP Semiconductors products in such equipment or applications and therefore such inclusion and/or use is at the customer's own risk.

Applications — Applications that are described herein for any of these products are for illustrative purposes only. NXP Semiconductors makes no representation or warranty that such applications will be suitable for the specified use without further testing or modification.

Customers are responsible for the design and operation of their applications and products using NXP Semiconductors products, and NXP Semiconductors accepts no liability for any assistance with applications or customer product design. It is customer's sole responsibility to determine whether the NXP Semiconductors product is suitable and fit for the customer's applications and products planned, as well as for the planned application and use of customer's third party customer(s). Customers should provide appropriate design and operating safeguards to minimize the risks associated with their applications and products.

NXP Semiconductors does not accept any liability related to any default, damage, costs or problem which is based on any weakness or default in the customer's applications or products, or the application or use by customer's third party customer(s). Customer is responsible for doing all necessary testing for the customer's applications and products using NXP Semiconductors products in order to avoid a default of the applications and the products or of the application or use by customer's third party customer(s). NXP does not accept any liability in this respect.

Limiting values — Stress above one or more limiting values (as defined in the Absolute Maximum Ratings System of IEC 60134) will cause permanent damage to the device. Limiting values are stress ratings only and (proper) operation of the device at these or any other conditions above those given in the Recommended operating conditions section (if present) or the Characteristics sections of this document is not warranted. Constant or repeated exposure to limiting values will permanently and irreversibly affect the quality and reliability of the device.

Terms and conditions of commercial sale — NXP Semiconductors products are sold subject to the general terms and conditions of commercial sale, as published at <http://www.nxp.com/profile/terms>, unless otherwise agreed in a valid written individual agreement. In case an individual agreement is concluded only the terms and conditions of the respective agreement shall apply. NXP Semiconductors hereby expressly objects to applying the customer's general terms and conditions with regard to the purchase of NXP Semiconductors products by customer.

No offer to sell or license — Nothing in this document may be interpreted or construed as an offer to sell products that is open for acceptance or the grant, conveyance or implication of any license under any copyrights, patents or other industrial or intellectual property rights.

Export control — This document as well as the item(s) described herein may be subject to export control regulations. Export might require a prior authorization from competent authorities.

Quick reference data — The Quick reference data is an extract of the product data given in the Limiting values and Characteristics sections of this document, and as such is not complete, exhaustive or legally binding.

Non-automotive qualified products — Unless this data sheet expressly states that this specific NXP Semiconductors product is automotive qualified, the product is not suitable for automotive use. It is neither qualified nor tested in accordance with automotive testing or application requirements. NXP Semiconductors accepts no liability for inclusion and/or use of non-automotive qualified products in automotive equipment or applications.

In the event that customer uses the product for design-in and use in automotive applications to automotive specifications and standards, customer (a) shall use the product without NXP Semiconductors' warranty of the product for such automotive applications, use and specifications, and (b)

whenever customer uses the product for automotive applications beyond NXP Semiconductors' specifications such use shall be solely at customer's own risk, and (c) customer fully indemnifies NXP Semiconductors for any liability, damages or failed product claims resulting from customer design and use of the product for automotive applications beyond NXP Semiconductors' standard warranty and NXP Semiconductors' product specifications.

Translations — A non-English (translated) version of a document is for reference only. The English version shall prevail in case of any discrepancy between the translated and English versions.

15.4 Trademarks

Notice: All referenced brands, product names, service names and trademarks are the property of their respective owners.

GreenChip — is a trademark of NXP B.V.

16. Contact information

For more information, please visit: <http://www.nxp.com>

For sales office addresses, please send an email to: salesaddresses@nxp.com

17. Contents

1	General description	1
2	Features and benefits	1
3	Applications	2
4	Quick reference data	2
5	Ordering information	2
5.1	Ordering options	2
6	Block diagram	3
7	Pinning information	4
7.1	Pinning	4
7.2	Pin description	4
8	Functional description	6
8.1	NXQ1TXH5 operating states	6
8.2	Protections	7
9	Limiting values	8
10	Thermal characteristics	8
11	Characteristics	8
12	Application information	10
12.1	Crystal oscillator	10
12.2	Supply decoupling	10
12.3	Snubber network	10
12.4	Exposed die-pad ground and thermal connection	10
12.5	Support interface	10
12.6	Application diagram	11
12.7	Efficiency	12
13	Package outline	13
14	Revision history	14
15	Legal information	15
15.1	Data sheet status	15
15.2	Definitions	15
15.3	Disclaimers	15
15.4	Trademarks	16
16	Contact information	16
17	Contents	17

Please be aware that important notices concerning this document and the product(s) described herein, have been included in section 'Legal information'.

© NXP Semiconductors N.V. 2016.

All rights reserved.

For more information, please visit: <http://www.nxp.com>

For sales office addresses, please send an email to: salesaddresses@nxp.com

Date of release: 4 March 2016

Document identifier: NXQ1TXH5