

## Important notice

Dear Customer,

On 7 February 2017 the former NXP Standard Product business became a new company with the tradename **Nexperia**. Nexperia is an industry leading supplier of Discrete, Logic and PowerMOS semiconductors with its focus on the automotive, industrial, computing, consumer and wearable application markets

In data sheets and application notes which still contain NXP or Philips Semiconductors references, use the references to Nexperia, as shown below.

Instead of <http://www.nxp.com>, <http://www.philips.com/> or <http://www.semiconductors.philips.com/>, use <http://www.nexperia.com>

Instead of [sales.addresses@www.nxp.com](mailto:sales.addresses@www.nxp.com) or [sales.addresses@www.semiconductors.philips.com](mailto:sales.addresses@www.semiconductors.philips.com), use [salesaddresses@nexperia.com](mailto:salesaddresses@nexperia.com) (email)

Replace the copyright notice at the bottom of each page or elsewhere in the document, depending on the version, as shown below:

- © NXP N.V. (year). All rights reserved or © Koninklijke Philips Electronics N.V. (year). All rights reserved

Should be replaced with:

- © **Nexperia B.V. (year). All rights reserved.**

If you have any questions related to the data sheet, please contact our nearest sales office via e-mail or telephone (details via [salesaddresses@nexperia.com](mailto:salesaddresses@nexperia.com)). Thank you for your cooperation and understanding,

Kind regards,

Team Nexperia

# BUK7575-100A

## N-channel TrenchMOS standard level FET

Rev. 02 — 30 July 2009

Product data sheet

## 1. Product profile

### 1.1 General description

Standard level N-channel enhancement mode Field-Effect Transistor (FET) in a plastic package using TrenchMOS technology. This product has been designed and qualified to the appropriate AEC standard for use in automotive critical applications.

### 1.2 Features and benefits

- Low conduction losses due to low on-state resistance
- Q101 compliant
- Suitable for standard level gate drive sources
- Suitable for thermally demanding environments due to 175 °C rating

### 1.3 Applications

- 12 V, 24 V and 42 V loads
- Automotive and general purpose power switching
- Motors, lamps and solenoids

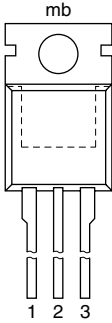
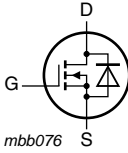
### 1.4 Quick reference data

Table 1. Quick reference

Symbol	Parameter	Conditions	Min	Typ	Max	Unit
$V_{DS}$	drain-source voltage	$T_j \geq 25\text{ °C}; T_j \leq 175\text{ °C}$	-	-	100	V
$I_D$	drain current	$V_{GS} = 10\text{ V}; T_{mb} = 25\text{ °C};$ see <a href="#">Figure 1</a> and <a href="#">3</a>	-	-	23	A
$P_{tot}$	total power dissipation	$T_{mb} = 25\text{ °C};$ see <a href="#">Figure 2</a>	-	-	99	W
<b>Avalanche ruggedness</b>						
$E_{DS(AL)S}$	non-repetitive drain-source avalanche energy	$I_D = 14\text{ A}; V_{sup} \leq 100\text{ V};$ $R_{GS} = 50\text{ }\Omega; V_{GS} = 10\text{ V};$ $T_{j(init)} = 25\text{ °C};$ unclamped	-	-	100	mJ
<b>Static characteristics</b>						
$R_{DSon}$	drain-source on-state resistance	$V_{GS} = 10\text{ V}; I_D = 13\text{ A};$ $T_j = 175\text{ °C};$ see <a href="#">Figure 12</a> and <a href="#">13</a>	-	-	187	m $\Omega$
		$V_{GS} = 10\text{ V}; I_D = 13\text{ A};$ $T_j = 25\text{ °C};$ see <a href="#">Figure 12</a> and <a href="#">13</a>	-	64	75	m $\Omega$

## 2. Pinning information

**Table 2. Pinning information**

Pin	Symbol	Description	Simplified outline	Graphic symbol
1	G	gate	 <p><b>SOT78A (TO-220AB)</b></p>	 <p><i>mbb076</i></p>
2	D	drain		
3	S	source		
mb	D	mounting base; connected to drain		

## 3. Ordering information

**Table 3. Ordering information**

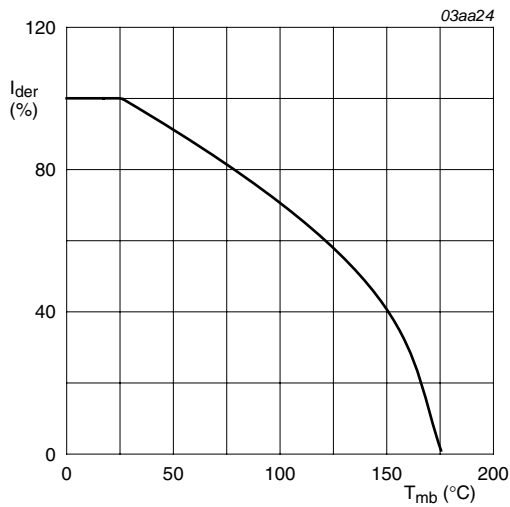
Type number	Package		Version
	Name	Description	
BUK7575-100A	TO-220AB	plastic single-ended package; heatsink mounted; 1 mounting hole; 3-lead TO-220AB	SOT78A

## 4. Limiting values

**Table 4. Limiting values**

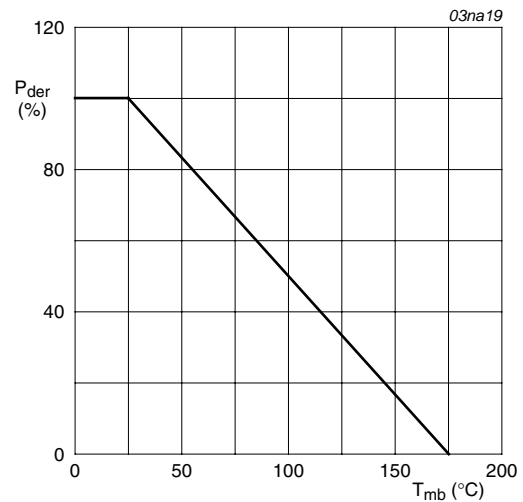
In accordance with the Absolute Maximum Rating System (IEC 60134).

Symbol	Parameter	Conditions	Min	Max	Unit
V <sub>DS</sub>	drain-source voltage	T <sub>j</sub> ≥ 25 °C; T <sub>j</sub> ≤ 175 °C	-	100	V
V <sub>DGR</sub>	drain-gate voltage	R <sub>GS</sub> = 20 kΩ	-	100	V
V <sub>GS</sub>	gate-source voltage		-20	20	V
I <sub>D</sub>	drain current	T <sub>mb</sub> = 25 °C; V <sub>GS</sub> = 10 V; see <a href="#">Figure 1</a> and <a href="#">3</a>	-	23	A
		T <sub>mb</sub> = 100 °C; V <sub>GS</sub> = 10 V; see <a href="#">Figure 1</a>	-	16.2	A
I <sub>DM</sub>	peak drain current	T <sub>mb</sub> = 25 °C; t <sub>p</sub> ≤ 10 μs; pulsed; see <a href="#">Figure 3</a>	-	92	A
P <sub>tot</sub>	total power dissipation	T <sub>mb</sub> = 25 °C; see <a href="#">Figure 2</a>	-	99	W
T <sub>stg</sub>	storage temperature		-55	175	°C
T <sub>j</sub>	junction temperature		-55	175	°C
<b>Source-drain diode</b>					
I <sub>S</sub>	source current	T <sub>mb</sub> = 25 °C	-	23	A
I <sub>SM</sub>	peak source current	t <sub>p</sub> ≤ 10 μs; pulsed; T <sub>mb</sub> = 25 °C	-	92	A
<b>Avalanche ruggedness</b>					
E <sub>DS(AL)S</sub>	non-repetitive drain-source avalanche energy	I <sub>D</sub> = 14 A; V <sub>sup</sub> ≤ 100 V; R <sub>GS</sub> = 50 Ω; V <sub>GS</sub> = 10 V; T <sub>j(init)</sub> = 25 °C; unclamped	-	100	mJ



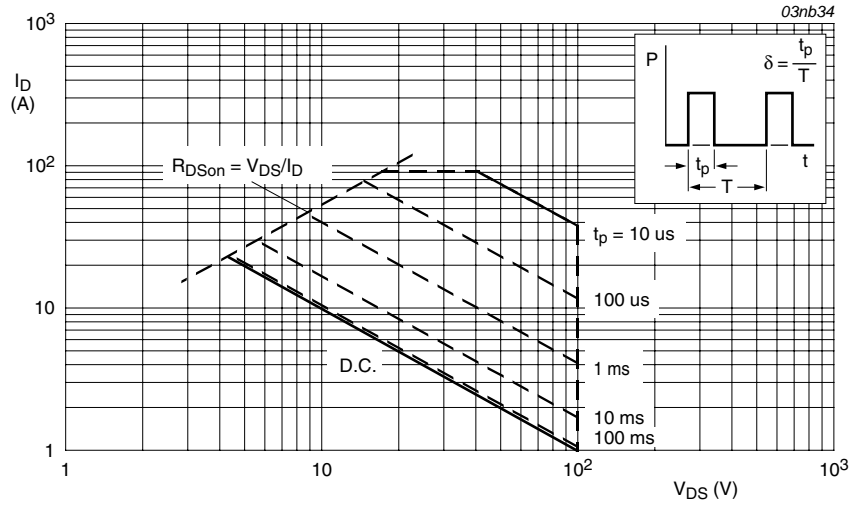
$$I_{der} = \frac{I_D}{I_{D(25^\circ\text{C})}} \times 100\%$$

**Fig 1. Normalized continuous drain current as a function of mounting base temperature**



$$P_{der} = \frac{P_{tot}}{P_{tot(25^\circ\text{C})}} \times 100\%$$

**Fig 2. Normalized total power dissipation as a function of mounting base temperature**

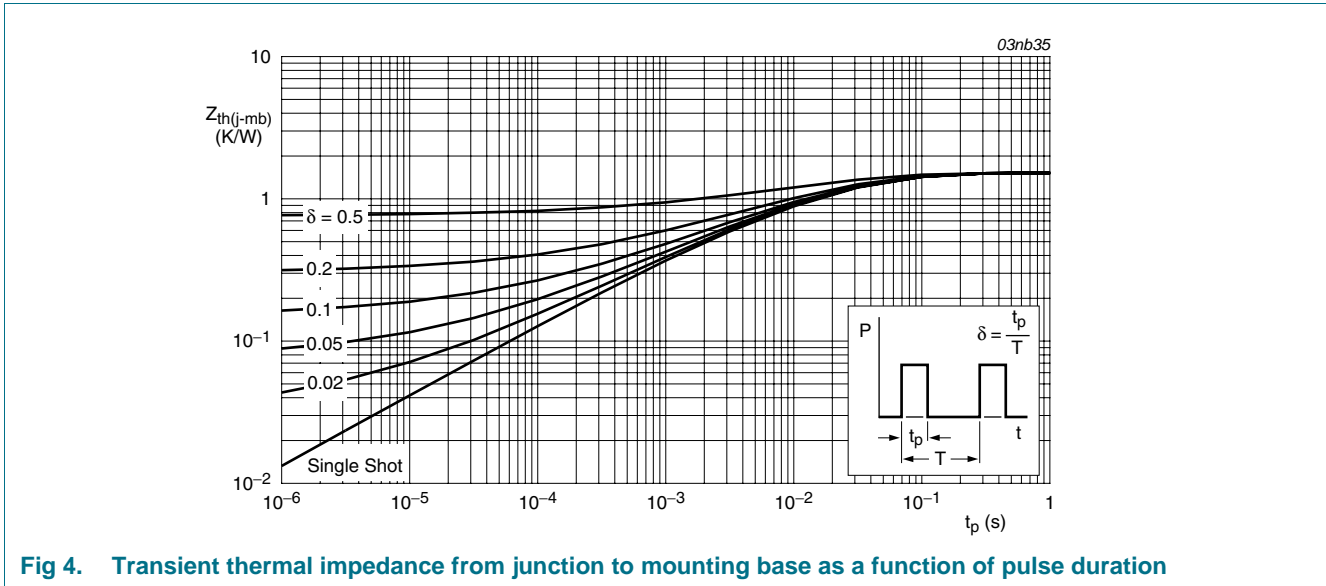


**Fig 3. Safe operating area; continuous and peak drain currents as a function of drain-source voltage**

## 5. Thermal characteristics

**Table 5. Thermal characteristics**

Symbol	Parameter	Conditions	Min	Typ	Max	Unit
$R_{th(j-mb)}$	thermal resistance from junction to mounting base	see <a href="#">Figure 4</a>	-	-	1.5	K/W
$R_{th(j-a)}$	thermal resistance from junction to ambient		-	60	-	K/W

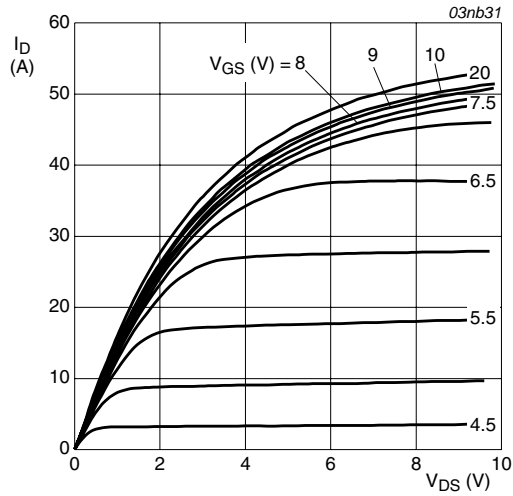


**Fig 4. Transient thermal impedance from junction to mounting base as a function of pulse duration**

## 6. Characteristics

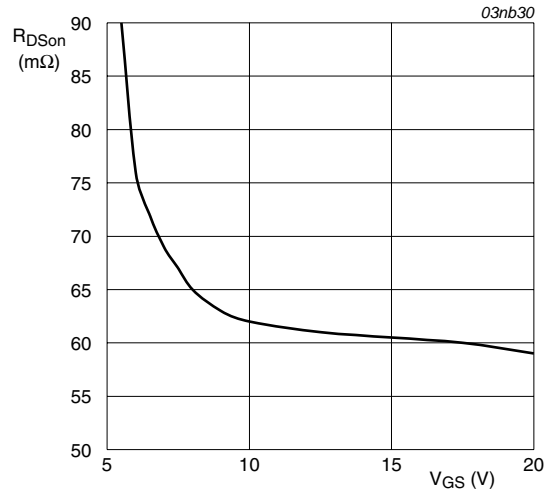
**Table 6. Characteristics**

Symbol	Parameter	Conditions	Min	Typ	Max	Unit
<b>Static characteristics</b>						
$V_{(BR)DSS}$	drain-source breakdown voltage	$I_D = 0.25 \text{ mA}; V_{GS} = 0 \text{ V}; T_j = 25 \text{ }^\circ\text{C}$	100	-	-	V
		$I_D = 0.25 \text{ mA}; V_{GS} = 0 \text{ V}; T_j = -55 \text{ }^\circ\text{C}$	89	-	-	V
$V_{GS(th)}$	gate-source threshold voltage	$I_D = 1 \text{ mA}; V_{DS} = V_{GS}; T_j = 175 \text{ }^\circ\text{C};$ see <a href="#">Figure 11</a>	1	-	-	V
		$I_D = 1 \text{ mA}; V_{DS} = V_{GS}; T_j = -55 \text{ }^\circ\text{C};$ see <a href="#">Figure 11</a>	-	-	4.4	V
		$I_D = 1 \text{ mA}; V_{DS} = V_{GS}; T_j = 25 \text{ }^\circ\text{C};$ see <a href="#">Figure 11</a>	2	3	4	V
$I_{DSS}$	drain leakage current	$V_{DS} = 100 \text{ V}; V_{GS} = 0 \text{ V}; T_j = 175 \text{ }^\circ\text{C}$	-	-	500	$\mu\text{A}$
		$V_{DS} = 100 \text{ V}; V_{GS} = 0 \text{ V}; T_j = 25 \text{ }^\circ\text{C}$	-	0.05	10	$\mu\text{A}$
$I_{GSS}$	gate leakage current	$V_{DS} = 0 \text{ V}; V_{GS} = 20 \text{ V}; T_j = 25 \text{ }^\circ\text{C}$	-	2	100	nA
		$V_{DS} = 0 \text{ V}; V_{GS} = -20 \text{ V}; T_j = 25 \text{ }^\circ\text{C}$	-	2	100	nA
$R_{DS(on)}$	drain-source on-state resistance	$V_{GS} = 10 \text{ V}; I_D = 13 \text{ A}; T_j = 175 \text{ }^\circ\text{C};$ see <a href="#">Figure 12</a> and <a href="#">13</a>	-	-	187	m $\Omega$
		$V_{GS} = 10 \text{ V}; I_D = 13 \text{ A}; T_j = 25 \text{ }^\circ\text{C};$ see <a href="#">Figure 12</a> and <a href="#">13</a>	-	64	75	m $\Omega$
<b>Dynamic characteristics</b>						
$C_{iss}$	input capacitance	$V_{GS} = 0 \text{ V}; V_{DS} = 25 \text{ V}; f = 1 \text{ MHz};$ $T_j = 25 \text{ }^\circ\text{C};$ see <a href="#">Figure 15</a>	-	907	1210	pF
$C_{oss}$	output capacitance		-	127	150	pF
$C_{rss}$	reverse transfer capacitance		-	78	110	pF
$t_{d(on)}$	turn-on delay time	$V_{DS} = 30 \text{ V}; R_L = 2.2 \text{ } \Omega; V_{GS} = 10 \text{ V};$ $R_{G(ext)} = 5.6 \text{ } \Omega; T_j = 25 \text{ }^\circ\text{C}$	-	8	-	ns
$t_r$	rise time		-	39	-	ns
$t_{d(off)}$	turn-off delay time		-	26	-	ns
$t_f$	fall time		-	24	-	ns
$L_D$	internal drain inductance	from drain lead 6 mm from package to centre of die; $T_j = 25 \text{ }^\circ\text{C}$	-	4.5	-	nH
		from contact screw on mounting base to centre of die; $T_j = 25 \text{ }^\circ\text{C}$	-	3.5	-	nH
$L_S$	internal source inductance	from source lead to source bond pad; $T_j = 25 \text{ }^\circ\text{C}$	-	7.5	-	nH
<b>Source-drain diode</b>						
$V_{SD}$	source-drain voltage	$I_S = 25 \text{ A}; V_{GS} = 0 \text{ V}; T_j = 25 \text{ }^\circ\text{C};$ see <a href="#">Figure 14</a>	-	0.85	1.2	V
$t_{rr}$	reverse recovery time	$I_S = 13 \text{ A}; dI_S/dt = -100 \text{ A}/\mu\text{s}; V_{GS} = -10 \text{ V};$ $V_{DS} = 30 \text{ V}; T_j = 25 \text{ }^\circ\text{C}$	-	64	-	ns
$Q_r$	recovered charge		-	120	-	nC



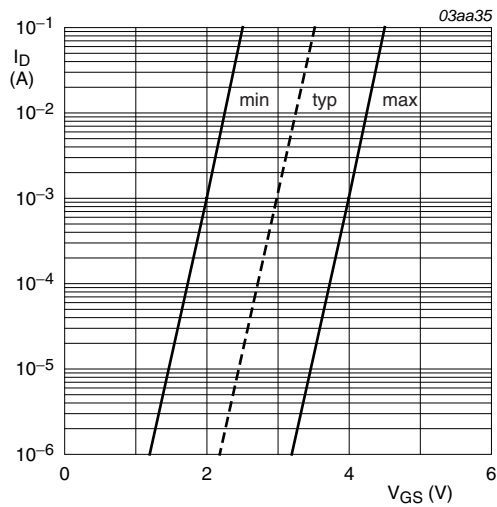
$T_j = 25^\circ\text{C}; t_p = 300\mu\text{s}$

**Fig 5. Output characteristics: drain current as a function of drain-source voltage; typical values**



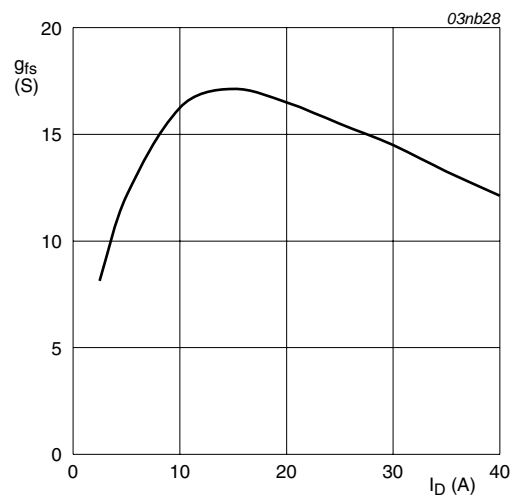
$T_j = 25^\circ\text{C}; I_D = 10\text{A}$

**Fig 6. Drain-source on-state resistance as a function of gate-source voltage; typical values**



$T_j = 25^\circ\text{C}; V_{DS} = 5\text{V}$

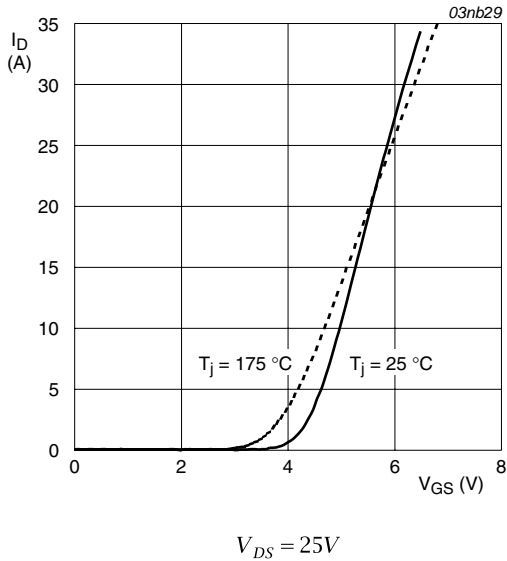
**Fig 7. Sub-threshold drain current as a function of gate-source voltage**



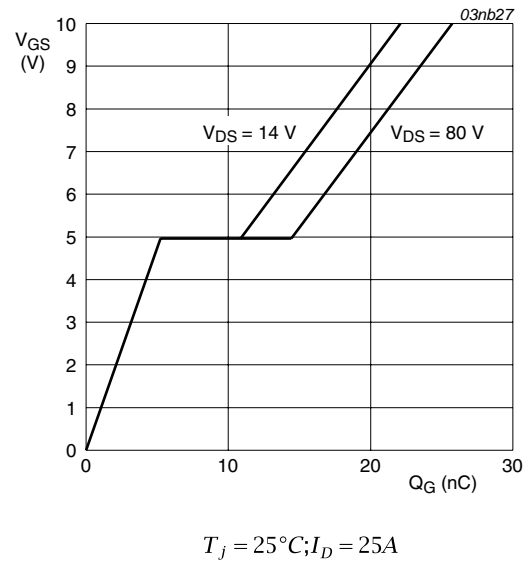
$T_j = 25^\circ\text{C}; V_{DS} = 25\text{V}$

**Fig 8. Forward transconductance as a function of drain current; typical values**

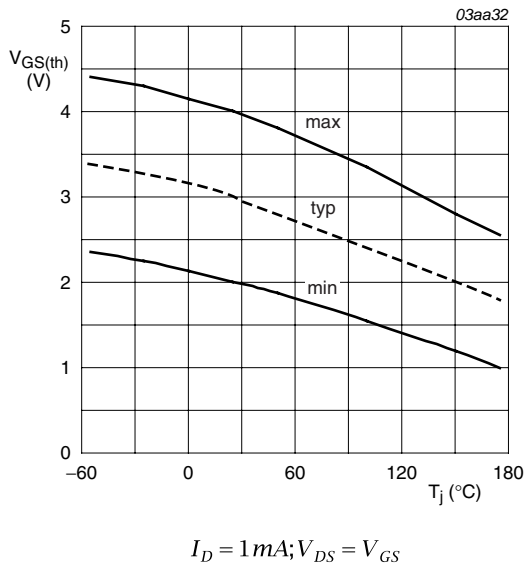




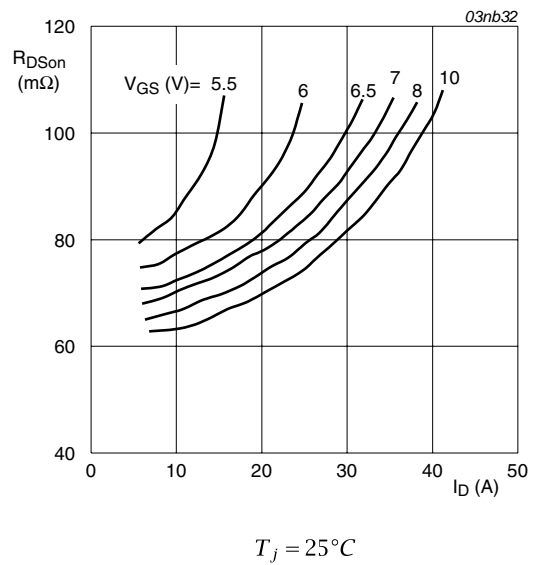
**Fig 9. Transfer characteristics: drain current as a function of gate-source voltage; typical values**



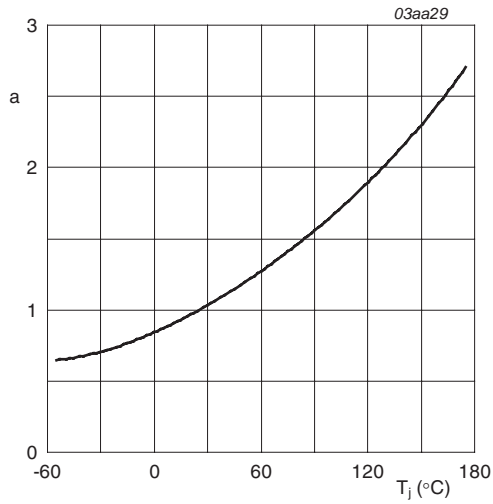
**Fig 10. Gate-source voltage as a function of turn-on gate charge; typical values**



**Fig 11. Gate-source threshold voltage as a function of junction temperature**

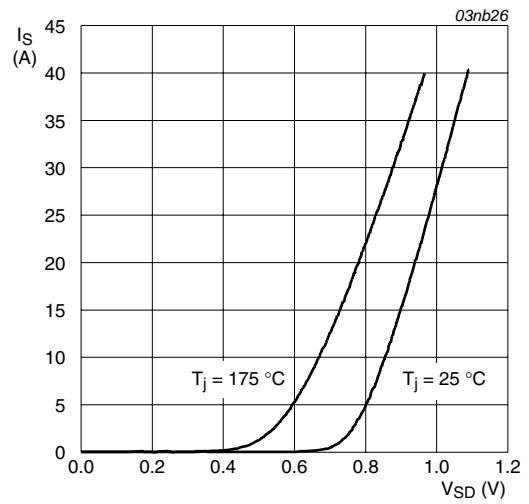


**Fig 12. Drain-source on-state resistance as a function of drain current; typical values**



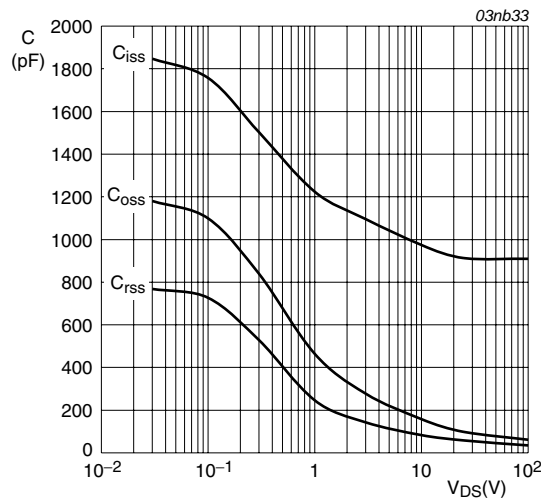
$$a = \frac{R_{DSon}}{R_{DSon(25^{\circ}\text{C})}}$$

**Fig 13. Normalized drain-source on-state resistance factor as a function of junction temperature**



$$V_{GS} = 0V$$

**Fig 14. Reverse diode current as a function of reverse diode voltage; typical values**



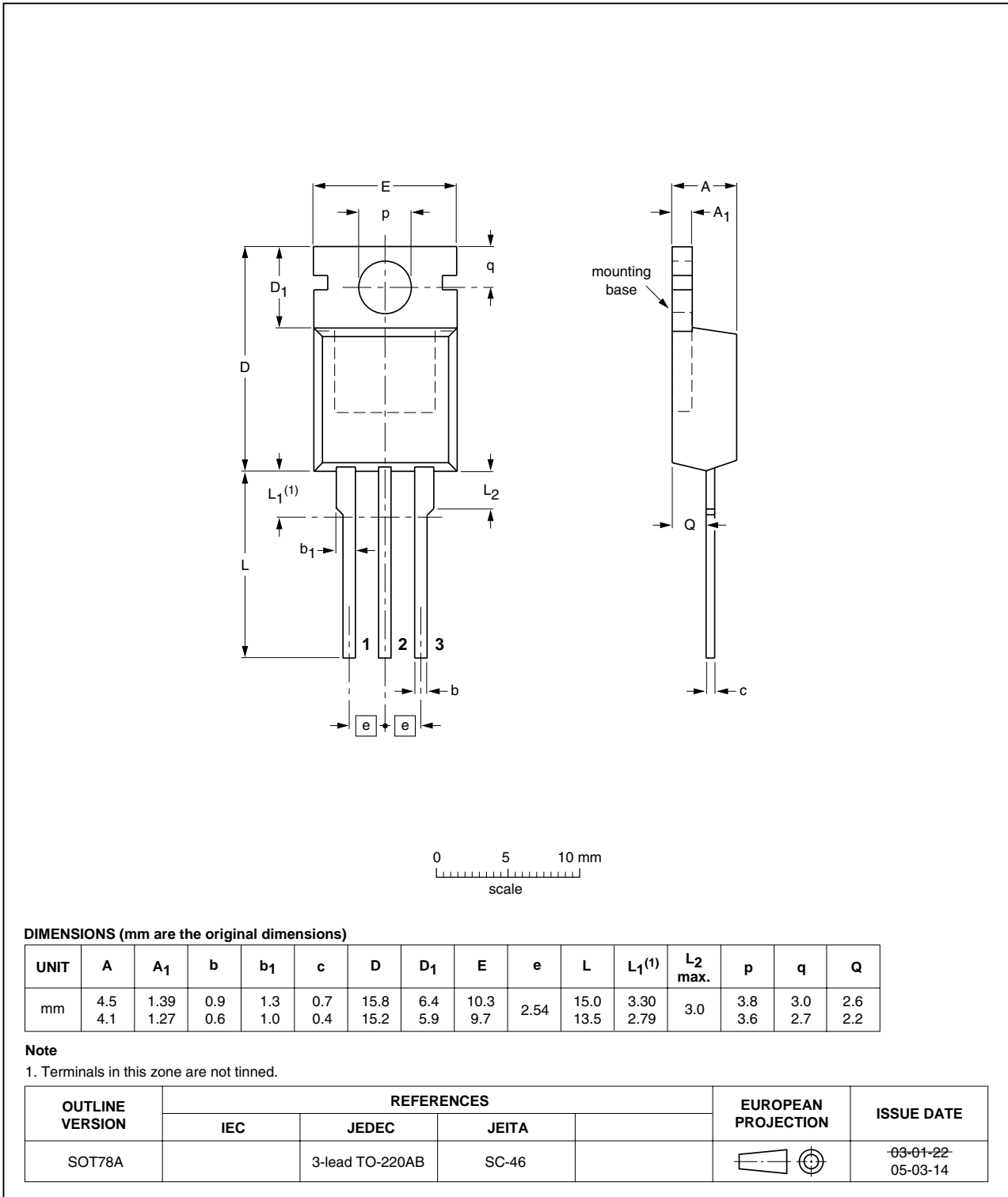
$$V_{GS} = 0V; f = 1MHz$$

**Fig 15. Input, output and reverse transfer capacitances as a function of drain-source voltage; typical values**

**7. Package outline**

Plastic single-ended package; heatsink mounted; 1 mounting hole; 3-lead TO-220AB

**SOT78A**



**Fig 16. Package outline SOT78A (TO-220AB)**

## 8. Revision history

Table 7. Revision history

Document ID	Release date	Data sheet status	Change notice	Supersedes
BUK7575-100A_2	20090730	Product data sheet	-	BUK7575_7675_100A-01
Modifications:		<ul style="list-style-type: none"><li>• The format of this data sheet has been redesigned to comply with the new identity guidelines of NXP Semiconductors.</li><li>• Legal texts have been adapted to the new company name where appropriate.</li><li>• Type number BUK7575-100A separated from data sheet BUK7575_7675_100A-01.</li></ul>		
BUK7575_7675_100A-01 (9397 750 07623)	20001024	Product specification	-	-

## 9. Legal information

### 9.1 Data sheet status

Document status <sup>[1][2]</sup>	Product status <sup>[3]</sup>	Definition
Objective [short] data sheet	Development	This document contains data from the objective specification for product development.
Preliminary [short] data sheet	Qualification	This document contains data from the preliminary specification.
Product [short] data sheet	Production	This document contains the product specification.

[1] Please consult the most recently issued document before initiating or completing a design.

[2] The term 'short data sheet' is explained in section "Definitions".

[3] The product status of device(s) described in this document may have changed since this document was published and may differ in case of multiple devices. The latest product status information is available on the Internet at URL <http://www.nxp.com>.

### 9.2 Definitions

**Draft** — The document is a draft version only. The content is still under internal review and subject to formal approval, which may result in modifications or additions. NXP Semiconductors does not give any representations or warranties as to the accuracy or completeness of information included herein and shall have no liability for the consequences of use of such information.

**Short data sheet** — A short data sheet is an extract from a full data sheet with the same product type number(s) and title. A short data sheet is intended for quick reference only and should not be relied upon to contain detailed and full information. For detailed and full information see the relevant full data sheet, which is available on request via the local NXP Semiconductors sales office. In case of any inconsistency or conflict with the short data sheet, the full data sheet shall prevail.

### 9.3 Disclaimers

**General** — Information in this document is believed to be accurate and reliable. However, NXP Semiconductors does not give any representations or warranties, expressed or implied, as to the accuracy or completeness of such information and shall have no liability for the consequences of use of such information.

**Right to make changes** — NXP Semiconductors reserves the right to make changes to information published in this document, including without limitation specifications and product descriptions, at any time and without notice. This document supersedes and replaces all information supplied prior to the publication hereof.

**Suitability for use** — NXP Semiconductors products are not designed, authorized or warranted to be suitable for use in medical, military, aircraft, space or life support equipment, nor in applications where failure or malfunction of an NXP Semiconductors product can reasonably be expected to result in personal injury, death or severe property or environmental damage. NXP Semiconductors accepts no liability for inclusion and/or use of NXP Semiconductors products in such equipment or applications and therefore such inclusion and/or use is at the customer's own risk.

**Applications** — Applications that are described herein for any of these products are for illustrative purposes only. NXP Semiconductors makes no representation or warranty that such applications will be suitable for the specified use without further testing or modification.

**Quick reference data** — The Quick reference data is an extract of the product data given in the Limiting values and Characteristics sections of this document, and as such is not complete, exhaustive or legally binding.

**Limiting values** — Stress above one or more limiting values (as defined in the Absolute Maximum Ratings System of IEC 60134) may cause permanent damage to the device. Limiting values are stress ratings only and operation of the device at these or any other conditions above those given in the Characteristics sections of this document is not implied. Exposure to limiting values for extended periods may affect device reliability.

**Terms and conditions of sale** — NXP Semiconductors products are sold subject to the general terms and conditions of commercial sale, as published at <http://www.nxp.com/profile/terms>, including those pertaining to warranty, intellectual property rights infringement and limitation of liability, unless explicitly otherwise agreed to in writing by NXP Semiconductors. In case of any inconsistency or conflict between information in this document and such terms and conditions, the latter will prevail.

**No offer to sell or license** — Nothing in this document may be interpreted or construed as an offer to sell products that is open for acceptance or the grant, conveyance or implication of any license under any copyrights, patents or other industrial or intellectual property rights.

**Export control** — This document as well as the item(s) described herein may be subject to export control regulations. Export might require a prior authorization from national authorities.

### 9.4 Trademarks

Notice: All referenced brands, product names, service names and trademarks are the property of their respective owners.

**TrenchMOS** — is a trademark of NXP B.V.

## 10. Contact information

For more information, please visit: <http://www.nxp.com>

For sales office addresses, please send an email to: [salesaddresses@nxp.com](mailto:salesaddresses@nxp.com)

## 11. Contents

<b>1</b>	<b>Product profile</b> . . . . .	<b>1</b>
1.1	General description . . . . .	1
1.2	Features and benefits . . . . .	1
1.3	Applications . . . . .	1
1.4	Quick reference data . . . . .	1
<b>2</b>	<b>Pinning information</b> . . . . .	<b>2</b>
<b>3</b>	<b>Ordering information</b> . . . . .	<b>2</b>
<b>4</b>	<b>Limiting values</b> . . . . .	<b>3</b>
<b>5</b>	<b>Thermal characteristics</b> . . . . .	<b>5</b>
<b>6</b>	<b>Characteristics</b> . . . . .	<b>6</b>
<b>7</b>	<b>Package outline</b> . . . . .	<b>10</b>
<b>8</b>	<b>Revision history</b> . . . . .	<b>11</b>
<b>9</b>	<b>Legal information</b> . . . . .	<b>12</b>
9.1	Data sheet status . . . . .	12
9.2	Definitions . . . . .	12
9.3	Disclaimers . . . . .	12
9.4	Trademarks . . . . .	12
<b>10</b>	<b>Contact information</b> . . . . .	<b>12</b>



Please be aware that important notices concerning this document and the product(s) described herein, have been included in section 'Legal information'.

© NXP B.V. 2009.

All rights reserved.

For more information, please visit: <http://www.nxp.com>

For sales office addresses, please send an email to: [salesaddresses@nxp.com](mailto:salesaddresses@nxp.com)

Date of release: 30 July 2009

Document identifier: BUK7575-100A\_2