

PART NO.	ME-302L WIRE	SCALE	1: 1
DESCRIPTION	SJT#16*3C 60C	UNIT:	mm
DWG No.	800-1603-0-SJT0-BL-00200		

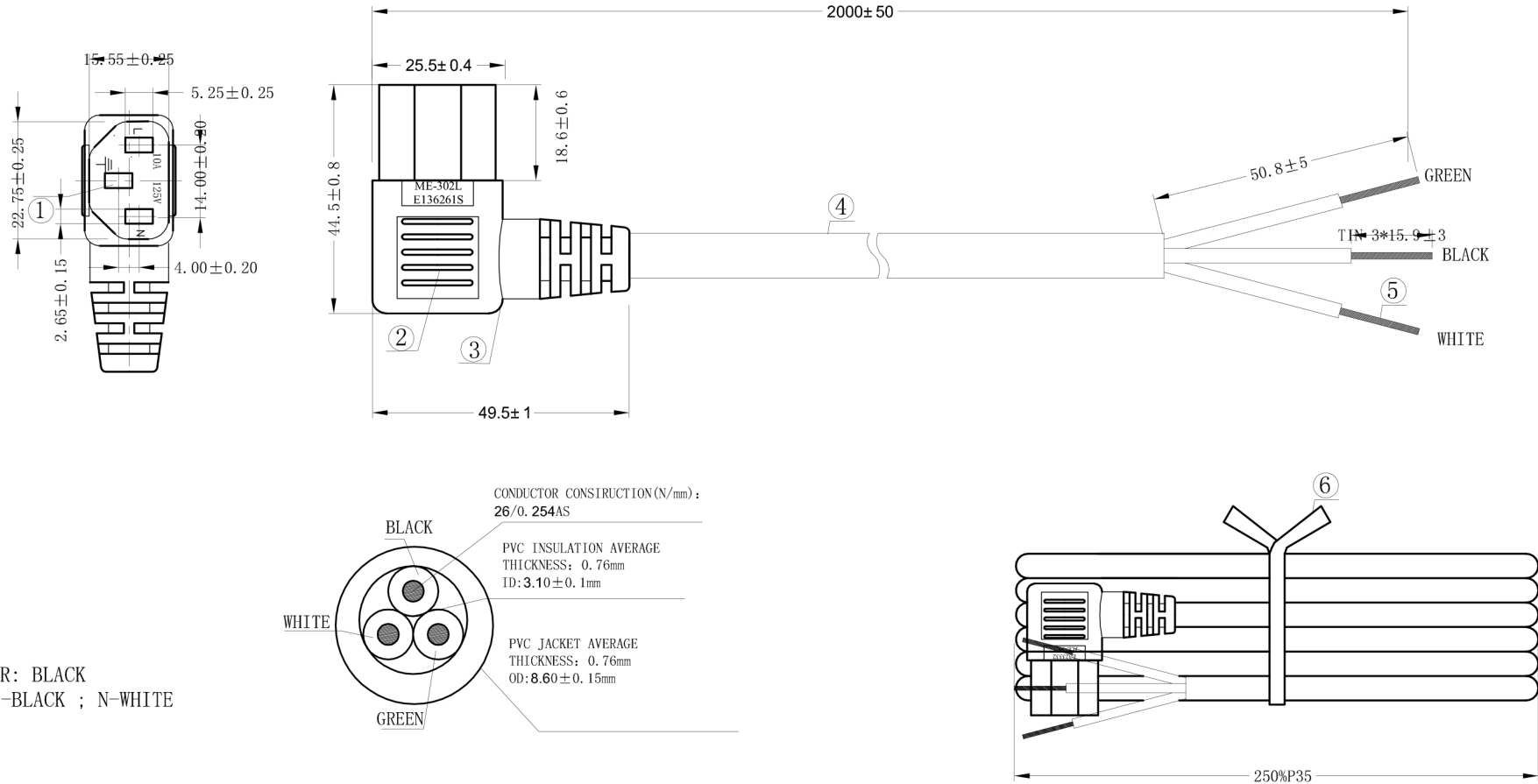

NOTES:

- 1) JACKET COLOR: BLACK
- 2). E-GREEN; L-BLACK ; N-WHITE

TESTING:

- 1) 100% OPEN & SHORT TESTING
- 2) INSULATION RESISTANCE: 100M ohm(min)
- 3) VOLTAGE: DC500V/1min
- 4) ROHS COMPLIANT

Printing the contents of wire The use of printing ink replenish Wire

E243929 (UL) SJT 3×16AWG(1.31mm²) VW-1 60°C 300V CSA 228191 SJT 3×16AWG(1.31mm²) FT2 60°C 300V -LF-

REV	DATE	DESCRIPTION	SYMBOL
DRAWN/DATE		CHECKED/DATE	
GONG/10.11.5		ZHUYING/10.11.6	

NO.	SPECIFICATION	COLOUR	MATERIAL	AMOUNT
①	Play home terminal 98740	Silver	Cu	3P
②	Model aircraft 8745AND	WHITE	PBT	1PCS
③	Mother Play ME-302L	BLACK	PVC Cu	1PCS
④	Wire SJT 16AWG/3C 60°	BLACK	PVC Cu	1PCS
⑤	Tin	Silver	Article tin	3PCS
⑥	Ties	BLACK		1PCS