

### General Description

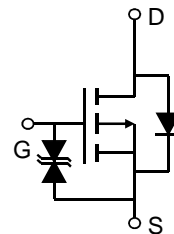
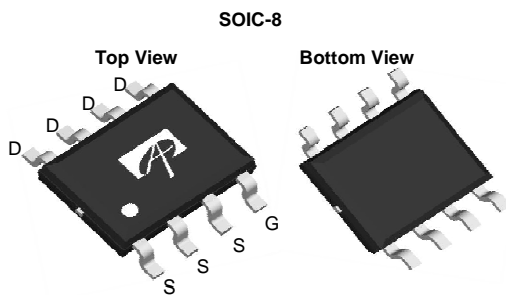
The AO4423 uses advanced trench technology to provide excellent  $R_{DS(ON)}$ , and ultra-low gate charge with a 25V gate rating. This device is suitable for use as a load switch or in PWM applications.

\* RoHS and Halogen-Free Compliant

### Product Summary

$V_{DS}$  (V) = -30V  
 $I_D$  = -17A ( $V_{GS} = -20V$ )  
 $R_{DS(ON)} < 6.2m\Omega$  ( $V_{GS} = -20V$ )  
 $R_{DS(ON)} < 7.2m\Omega$  ( $V_{GS} = -10V$ )

ESD Protected  
 100% UIS tested  
 100% Rg tested (note \*)



### Absolute Maximum Ratings $T_A=25^\circ\text{C}$ unless otherwise noted

Parameter	Symbol	Maximum	Units
Drain-Source Voltage	$V_{DS}$	-30	V
Gate-Source Voltage	$V_{GS}$	$\pm 25$	V
Continuous Drain Current <sup>AF</sup>	$I_D$	$T_A=25^\circ\text{C}$	-17
		$T_A=70^\circ\text{C}$	-14
Pulsed Drain Current <sup>B</sup>	$I_{DM}$	-182	A
Power Dissipation <sup>A</sup>	$P_D$	$T_A=25^\circ\text{C}$	3.1
		$T_A=70^\circ\text{C}$	2
Junction and Storage Temperature Range	$T_J, T_{STG}$	-55 to 150	$^\circ\text{C}$

### Thermal Characteristics

Parameter	Symbol	Typ	Max	Units
Maximum Junction-to-Ambient <sup>AF</sup>	$R_{\theta JA}$	$t \leq 10s$	26	$^\circ\text{C/W}$
Maximum Junction-to-Ambient <sup>A</sup>		Steady-State	50	$^\circ\text{C/W}$
Maximum Junction-to-Lead <sup>C</sup>	$R_{\theta JL}$	14	24	$^\circ\text{C/W}$

**Electrical Characteristics (T<sub>J</sub>=25°C unless otherwise noted)**

Symbol	Parameter	Conditions	Min	Typ	Max	Units
<b>STATIC PARAMETERS</b>						
BV <sub>DSS</sub>	Drain-Source Breakdown Voltage	I <sub>D</sub> =-250μA, V <sub>GS</sub> =0V	-30			V
I <sub>DSS</sub>	Zero Gate Voltage Drain Current	V <sub>DS</sub> =-30V, V <sub>GS</sub> =0V T <sub>J</sub> =55°C			-1 -5	μA
I <sub>GSS</sub>	Gate-Body leakage current	V <sub>DS</sub> =0V, V <sub>GS</sub> =±20V V <sub>DS</sub> =0V, V <sub>GS</sub> =±25V			±1 ±10	μA
V <sub>GS(th)</sub>	Gate Threshold Voltage	V <sub>DS</sub> =V <sub>GS</sub> I <sub>D</sub> =-250μA	-1.5	-2.1	-2.6	V
I <sub>D(ON)</sub>	On state drain current	V <sub>GS</sub> =-10V, V <sub>DS</sub> =-5V	-182			A
R <sub>DS(ON)</sub>	Static Drain-Source On-Resistance	V <sub>GS</sub> =-20V, I <sub>D</sub> =-15A T <sub>J</sub> =125°C V <sub>GS</sub> =-10V, I <sub>D</sub> =-15A V <sub>GS</sub> =-6V, I <sub>D</sub> =-10A		5.1 7.4 5.9 7.5	6.2 9 7.2 9.5	mΩ
g <sub>FS</sub>	Forward Transconductance	V <sub>DS</sub> =-5V, I <sub>D</sub> =-15A		48		S
V <sub>SD</sub>	Diode Forward Voltage	I <sub>S</sub> =-1A, V <sub>GS</sub> =0V		-0.71	-1	V
I <sub>S</sub>	Maximum Body-Diode Continuous Current				-4.2	A
<b>DYNAMIC PARAMETERS</b>						
C <sub>iss</sub>	Input Capacitance	V <sub>GS</sub> =0V, V <sub>DS</sub> =-15V, f=1MHz		2527	3033	pF
C <sub>oss</sub>	Output Capacitance			583		pF
C <sub>rss</sub>	Reverse Transfer Capacitance			397	556	pF
R <sub>g</sub>	Gate resistance	V <sub>GS</sub> =0V, V <sub>DS</sub> =0V, f=1MHz	2.1	4.3	6.4	Ω
<b>SWITCHING PARAMETERS</b>						
Q <sub>g</sub>	Total Gate Charge	V <sub>GS</sub> =-10V, V <sub>DS</sub> =-15V, I <sub>D</sub> =-15A		47	57	nC
Q <sub>gs</sub>	Gate Source Charge			8		nC
Q <sub>gd</sub>	Gate Drain Charge			14		nC
t <sub>D(on)</sub>	Turn-On DelayTime	V <sub>GS</sub> =-10V, V <sub>DS</sub> =-15V, R <sub>L</sub> =1.0Ω, R <sub>GEN</sub> =3Ω		12		ns
t <sub>r</sub>	Turn-On Rise Time			8		ns
t <sub>D(off)</sub>	Turn-Off DelayTime			54		ns
t <sub>f</sub>	Turn-Off Fall Time			87		ns
t <sub>rr</sub>	Body Diode Reverse Recovery Time	I <sub>F</sub> =-15A, dI/dt=100A/μs		26.1	32	ns
Q <sub>rr</sub>	Body Diode Reverse Recovery Charge	I <sub>F</sub> =-15A, dI/dt=100A/μs		12.3		nC

A: The value of R<sub>θJA</sub> is measured with the device mounted on 1 in 2 FR-4 board with 2oz. Copper, in a still air environment with T<sub>A</sub>=25° C. The value in any given application depends on the user's specific board design.

B: Repetitive rating, pulse width limited by junction temperature.

C: The R<sub>θJA</sub> is the sum of the thermal impedance from junction to lead R<sub>θJL</sub> and lead to ambient.

D: The static characteristics in Figures 1 to 6 are obtained using <300 μs pulses, duty cycle 0.5% max.

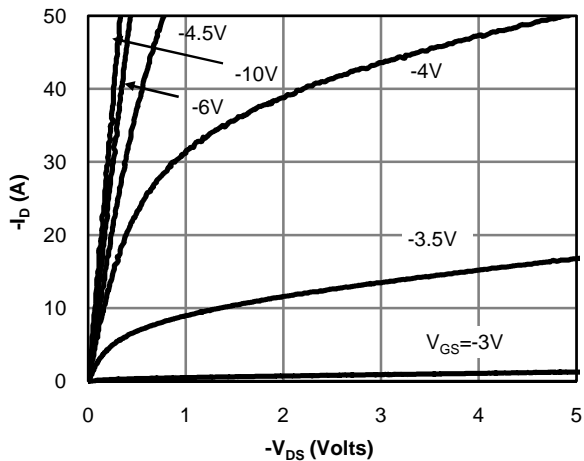
E: These tests are performed with the device mounted on 1 in 2 FR-4 board with 2oz. Copper, in a still air environment with T<sub>A</sub>=25° C. The SOA curve provides a single pulse rating.

F: The current rating is based on the t ≤ 10s junction to ambient thermal resistance rating.

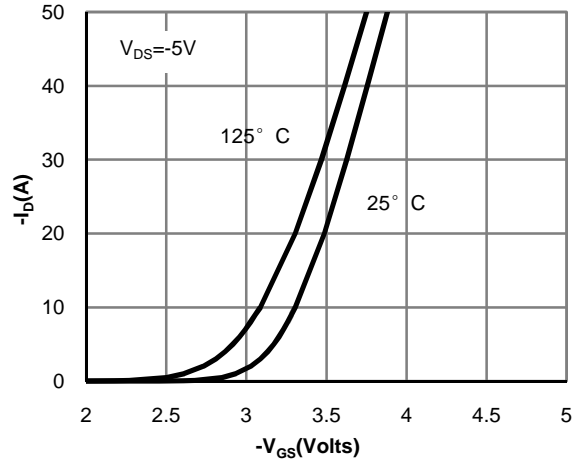
Note \*: This device is guaranteed RG 100% tested after date code 8V11 (Jan 1st 2008)

THIS PRODUCT HAS BEEN DESIGNED AND QUALIFIED FOR THE CONSUMER MARKET. APPLICATIONS OR USES AS CRITICAL COMPONENTS IN LIFE SUPPORT DEVICES OR SYSTEMS ARE NOT AUTHORIZED. AOS DOES NOT ASSUME ANY LIABILITY ARISING OUT OF SUCH APPLICATIONS OR USES OF ITS PRODUCTS. AOS RESERVES THE RIGHT TO IMPROVE PRODUCT DESIGN, FUNCTIONS AND RELIABILITY WITHOUT NOTICE

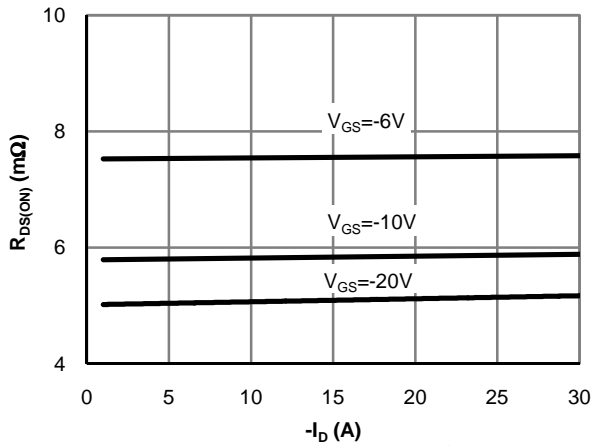
**TYPICAL ELECTRICAL AND THERMAL CHARACTERISTICS**



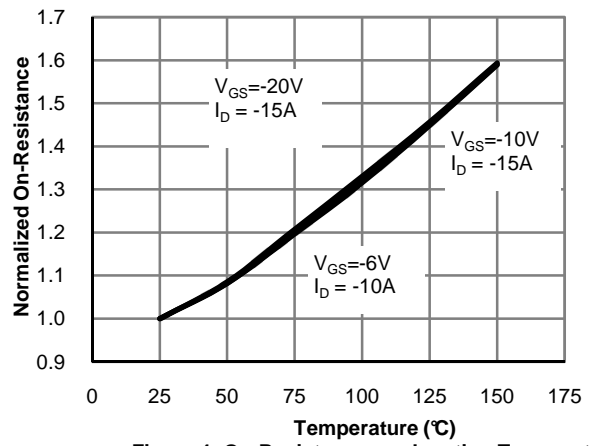
**Fig 1: On-Region Characteristics**



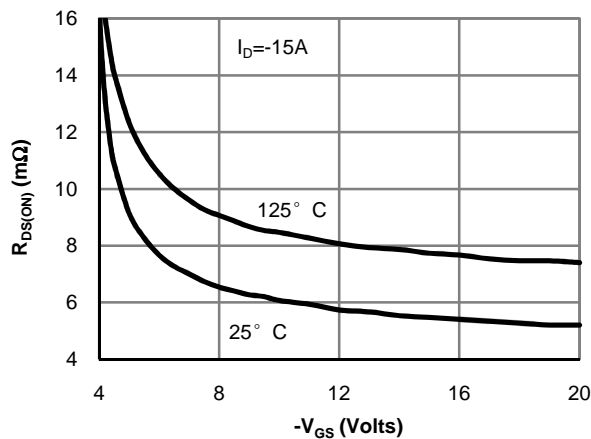
**Figure 2: Transfer Characteristics**



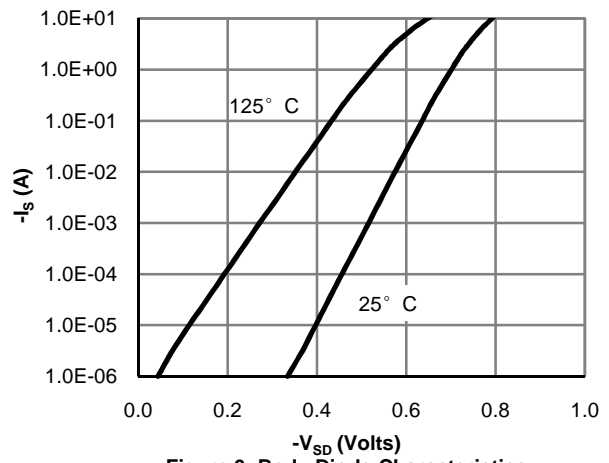
**Figure 3: On-Resistance vs. Drain Current and Gate Voltage**



**Figure 4: On-Resistance vs. Junction Temperature**

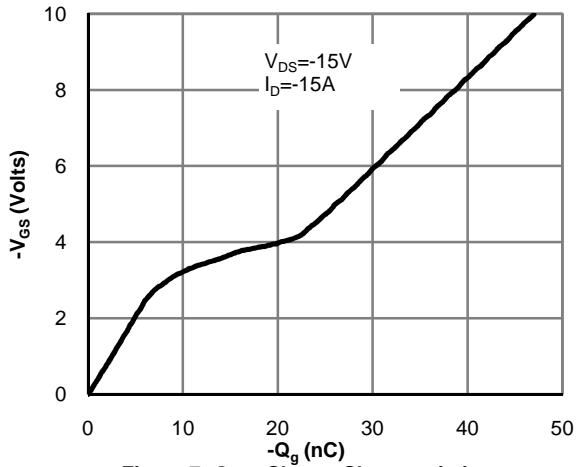


**Figure 5: On-Resistance vs. Gate-Source Voltage**

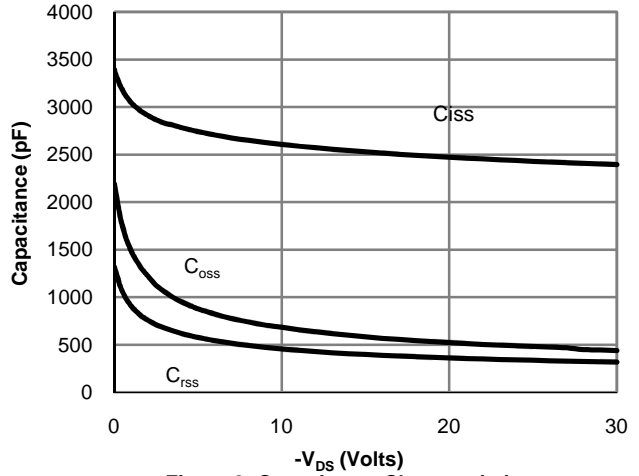


**Figure 6: Body-Diode Characteristics**

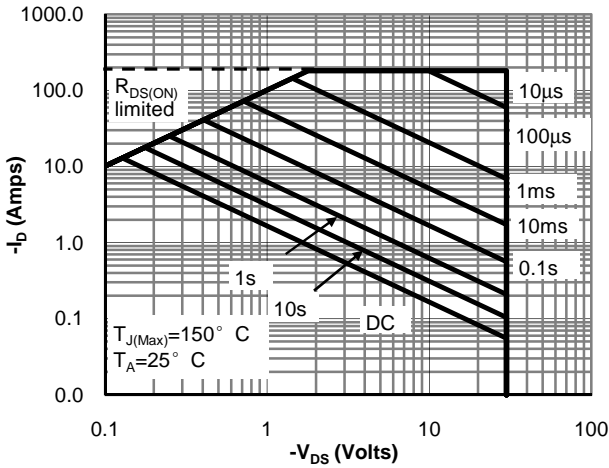
**TYPICAL ELECTRICAL AND THERMAL CHARACTERISTICS**



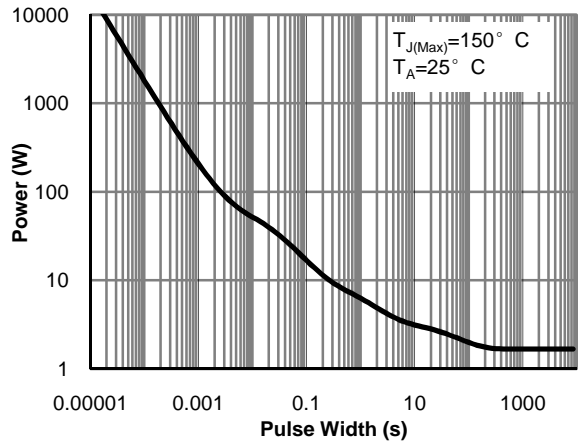
**Figure 7: Gate-Charge Characteristics**



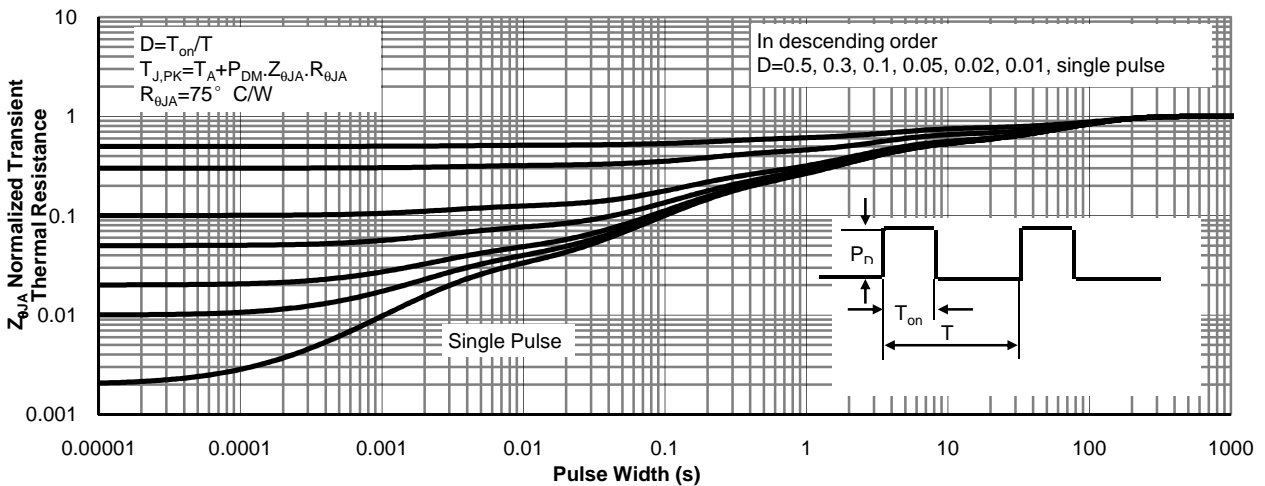
**Figure 8: Capacitance Characteristics**



**Figure 9: Maximum Forward Biased Safe**

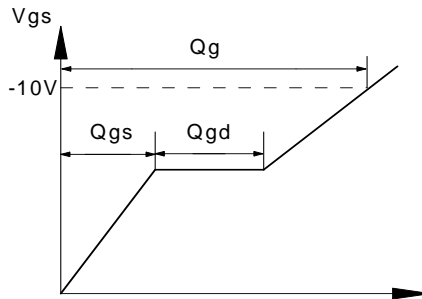
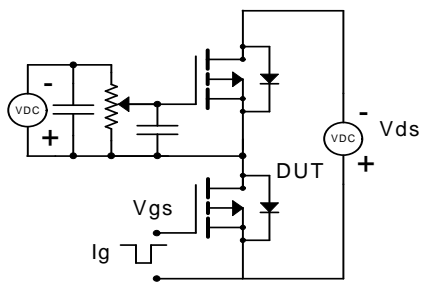


**Figure 10: Single Pulse Power Rating Junction-to-Ambient (Note E)**

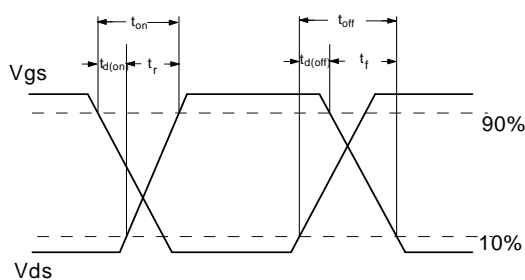
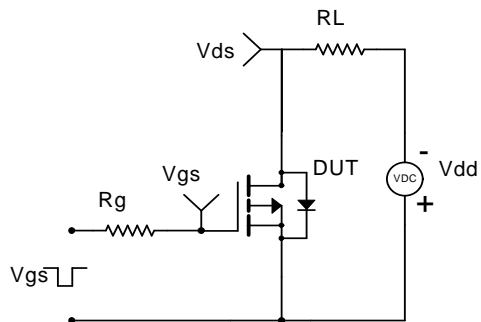


**Figure 11: Normalized Maximum Transient Thermal Impedance**

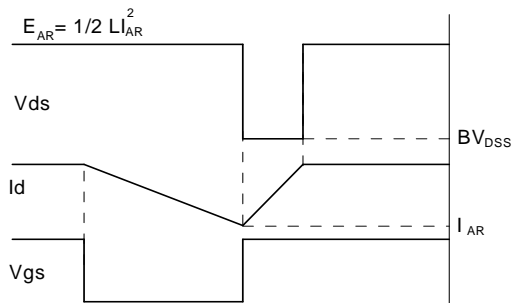
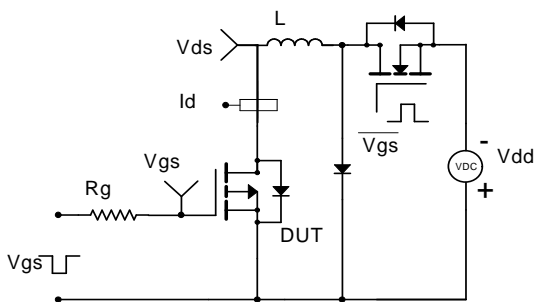
### Gate Charge Test Circuit & Waveform



### Resistive Switching Test Circuit & Waveforms



### Unclamped Inductive Switching (UIS) Test Circuit & Waveforms



### Diode Recovery Test Circuit & Waveforms

