

HC-DS 29 T

Order No.: 1772719



<http://eshop.phoenixcontact.de/phoenix/treeViewClick.do?UID=1772719>

Pressure screws, with flared cable guard, clamping area 20 mm ... 27 mm, for housing with Pg29 support

Commercial data

EAN	4017918037369
Pack	10 pcs.
Customs tariff	74153300
Weight/Piece	0.08744 KG
Catalog page information	Page 525 (PC-2009)

Product notes

WEEE/RoHS-compliant since:
04/10/2006



<http://www.download.phoenixcontact.com>
Please note that the data given here has been taken from the online catalog. For comprehensive information and data, please refer to the user documentation. The General Terms and Conditions of Use apply to Internet downloads.

Technical data

General data

Material, pressure screw	Nickel-plated brass
Thread type on connection side	Pg29
Clamping range of the strain relief clip	20.00 mm ... 27.00 mm

Certificates / Approvals



Certification

GOST

Diagrams/Drawings

Dimensioned drawing

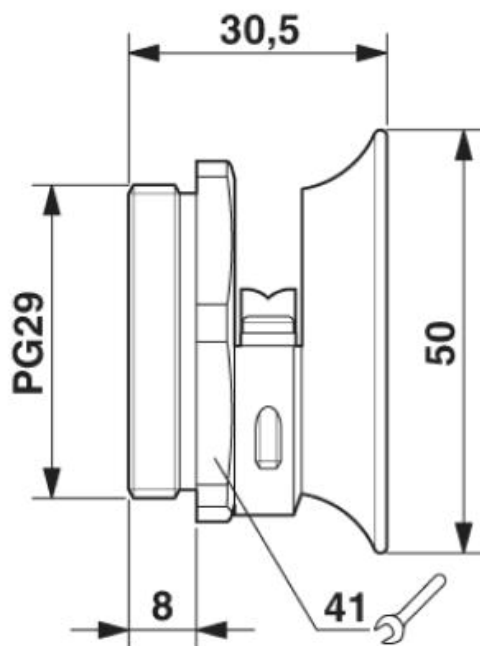

Address

PHOENIX CONTACT Deutschland GmbH
Flachmarktstr. 8
32825 Blomberg, Germany
Phone +49 5235 3 12000
Fax +49 5235 3 41200
<http://www.phoenixcontact.de>



© 2010 Phoenix Contact
Technical modifications reserved;