

Basic Characteristics Data

Model	Circuit method	Switching frequency [kHz]	Input current [A]	Rated input fuse	Inrush current protection	PCB/Pattern			Series/Parallel operation availability	
						Material	Single sided	Double sided	Series operation	Parallel operation
FCA50F	Forward converter	120	0.55(AC240V)	500V 5A	Thermistor	CEM-3	Yes		Yes	No
			0.30(AC480V)							
FCA75F	Forward converter	120	0.80(AC240V)	500V 5A	Thermistor	CEM-3	Yes		Yes	No
			0.45(AC480V)							
FCA200F	Active filter	80	1.10(AC240V)	500V 10A	Thermistor	CEM-3	Yes		Yes	No
	Forward converter	120	0.55(AC480V)							

* The value of input current is at ACIN 240V and rated load.

1	Terminal Block	FCA-10
2	Function	FCA-10
2.1	Input voltage range	FCA-10
2.2	Inrush current limiting	FCA-10
2.3	Overcurrent protection	FCA-10
2.4	Peak current protection	FCA-10
2.5	Thermal protection	FCA-10
2.6	Overvoltage protection	FCA-10
2.7	Output voltage adjustment range	FCA-10
2.8	Isolation	FCA-11
3	Series Operation and Parallel Operation	FCA-11
3.1	Series operation	FCA-11
3.2	Parallel operation	FCA-11
4	Assembling and Installation Method	FCA-11
4.1	Installation method	FCA-11
4.2	Derating	FCA-11
4.3	Mounting screw	FCA-12
5	Peak Loading	FCA-12

1 Terminal Block

● FCA50F

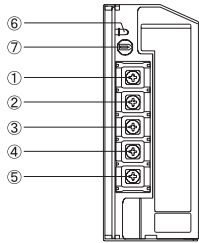

- ①+V
- ②-V
- ③FG
- ④AC(L)
- ⑤AC(N)
- ⑥LED
- ⑦Output voltage adjustable potentiometer

● FCA75F

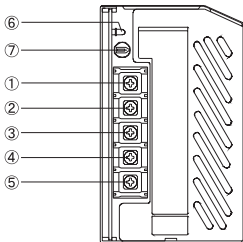

- ①+V
- ②-V
- ③FG
- ④AC(L)
- ⑤AC(N)
- ⑥LED
- ⑦Output voltage adjustable potentiometer

● FCA200F

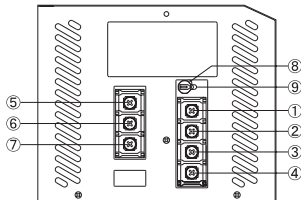

- ①+V
- ②+V
- ③-V
- ④-V
- ⑤FG
- ⑥AC(L)
- ⑦AC(N)
- ⑧Output voltage adjustable potentiometer
- ⑨LED

2 Function

2.1 Input voltage range

- The range is from AC187V to AC528V single phase.
AC input voltage must have a range from AC187V to AC528V for normal operation. If the wrong input is applied, the unit will not operate properly and/or may be damaged.
- In cases that conform with safety standard, input voltage range is AC240-AC480V(50/60Hz).

2.2 Inrush current limiting

- Inrush current limiting is built-in.
- If a switch on the input side is installed, it has to be the one handling the input inrush current.
The thermistor is used for protection from inrush current. When power is turned ON/OFF repeatedly within a short period of time, it is necessary to have enough time for power supply to cool down.

2.3 Overcurrent protection

- Overcurrent protection is built-in and comes into effect at over 105% of the rated current.
Overcurrent protection prevents the unit from short-circuit, overcurrent, or peak current exceeding the specified range.
The unit automatically recovers when the fault condition is cleared.

2.4 Peak current protection

- Peak current protection is built into FCA200F.
When the power supply is operated at as follows, this function comes into effect and shut down the output.
 - ①Continuous over rated current.
 - ②Over peakload based on 2.8 peak current.
Output shall resume about 120 seconds after power is turned off.

2.5 Thermal protection

- Thermal protection is built into FCA200F.
When the power supply is operated at as follows, this function comes into effect and shut down the output.
 - ①Over rated temperature.
 - ②Poor ventilation.
 - ③Continuous over rated current.
 - ④Over peakload based on 2.8 peak current.
Turn off power and drop the temperature to normal level.
Output shall resume after applying input voltage.

2.6 Overvoltage protection

- Overvoltage protection is built-in and comes into effect at 115 - 140% of the rated voltage.
The AC input should be shut down if overvoltage protection is in operation.
The minimum interval of AC recycling for recovery is 2 to 3 minutes.
The recovery time varies depending on input voltage and load during operation.

Remarks:

Please avoid applying the over-rated voltage to the output terminal. Power supply may operate incorrectly or fail. In case of operating a motor etc., please install an external diode on the output terminal to protect the unit.

2.7 Output voltage adjustment range

- Adjustment of output voltage is possible by using potentiometer.
- Output voltage is increased by turning potentiometer clockwise and is decreased by turning potentiometer counterclockwise.

2.8 Isolation

- For a receiving inspection, such as Hi-Pot test gradually increase (decrease) the voltage for the start (shut down) .
- Avoid using Hi-Pot tester with the timer because it may generate voltage a few times higher than the applied voltage, at ON/OFF of a timer.
- If the unit is tested on the isolation between input & output and out-put & FG, remote ON/OFF (option) must be shorted to outputs.

3 Series Operation and Parallel Operation

3.1 Series operation

- Series operation is available by connecting the outputs of two or more power supplies with the same output voltage, as shown below. Output current in series connection should be lower than the lowest rated current in each unit.

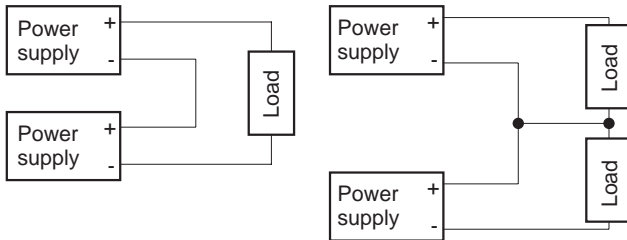

3.2 Parallel operation

- Parallel operation is not possible.

4 Assembling and Installation Method

4.1 Installation method

- When two or more power supplies are used side by side, position them with proper intervals to allow enough air ventilation. Ambient temperature around each power supply should not exceed the temperature range shown in derating curve.
- When cooling by forced air, arrange the fan so that ventilation can be fully obtained inside the power unit.
- Option with DIN rail attachment(option symbol:-N1) is only for mounting A. Otherwise, vibration and shock will make the power unit come off, which is dangerous.

4.2 Derating

- According to mounting directions, ambient temperature and load factor differ. Refer to the derating table below.

In the hatched area, the specification of Ripple, Ripple noise is deferent from other area.

● FCA50F/75F

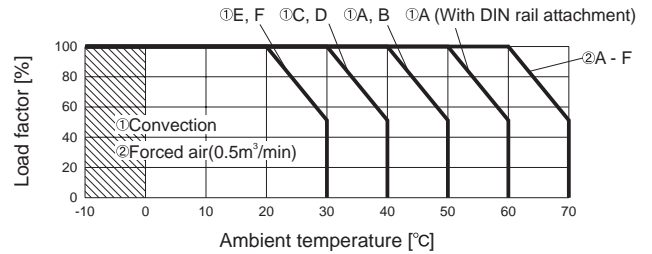

- Installation method

● Mounting screw

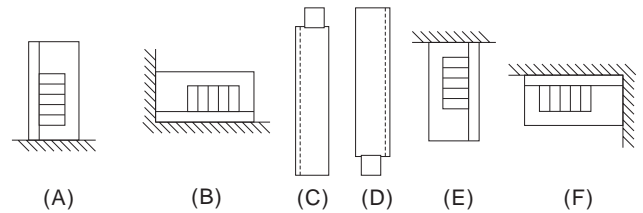

● Mounting DIN rail (Option with DIN rail attachment. Option symbol: N1)

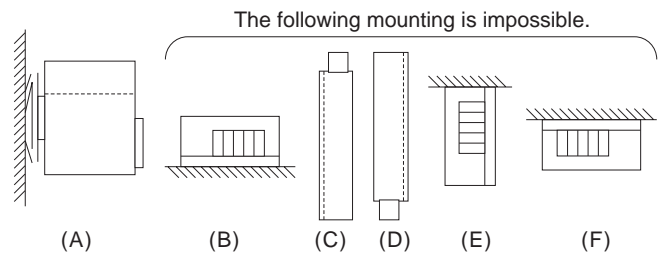

● FCA200F

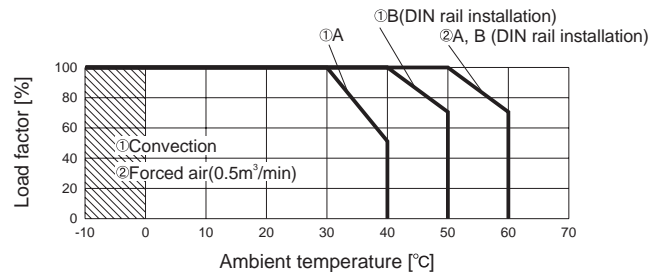

FCA

● Mounting screw installation

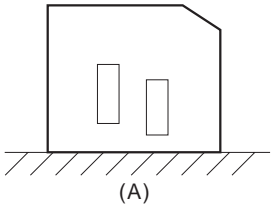

(A)

● Mounting DIN rail (Option:-N1) installation

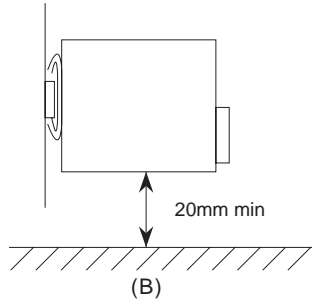

(B)

Remarks:

Mounting DIN rail installation is standard position only. Please do not try to install with the ways except (B) since a unit will be removed by vibration and impact and it will be dangerous.

4.3 Mounting screw

■ Keep isolation distance between screw and internal components as below chart.

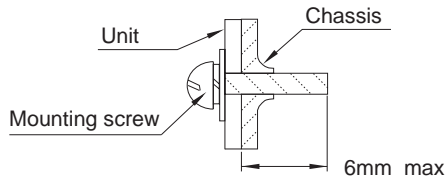

5 Peak Loading

- Avoid the use except under the following conditions, or failure of internal elements may be caused.
- Because of the characteristic of load(pulse load), noise may be generated from the power unit. Prior to use in the quiet location, checking is required.

● FCA50F/75F

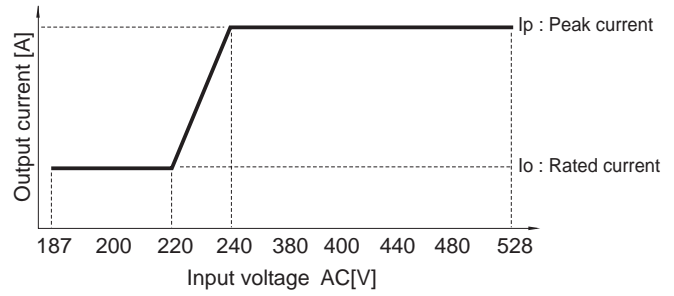
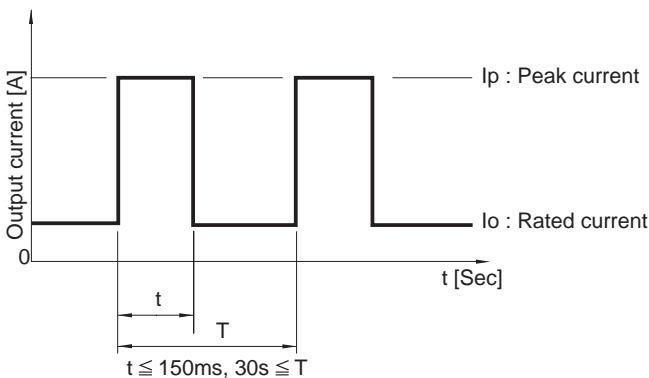

● FCA200F

