

REV.	DATE	DESCRIPTION
NC	08/25/04	INITIAL RELEASE

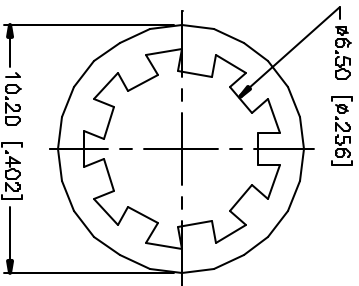
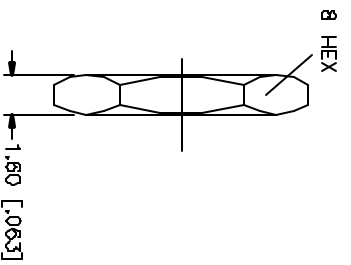
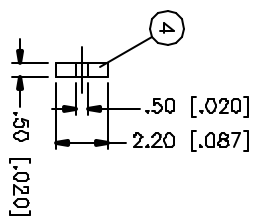
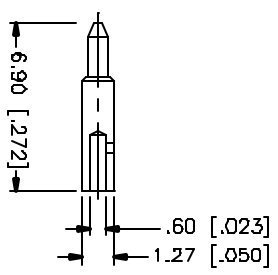
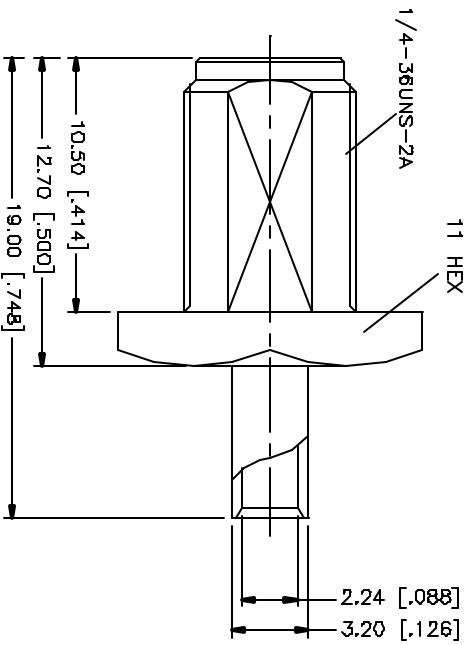
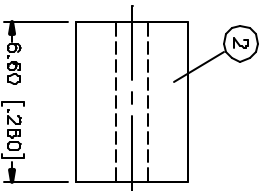
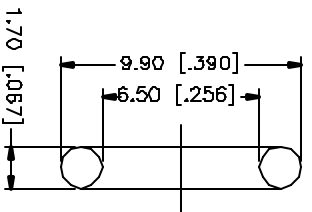
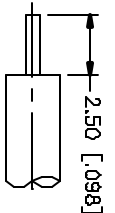

NOTE:
 1. CONTACT PIN TO SOLDER.
 2. MAX. PANEL THICKNESS = 2.4mm

B	DESCRIPTION	MATERIAL	FINISH	QTY	DO NOT SCALE DRAWING
8	FERRULE	BRASS	GOLD		
7	LOCK WASHER	BRASS	GOLD		
6	GASKET	SILICONE	RED		
5	INSULATOR	TEFLON	NATURAL		
4	CONTACT PIN	BRASS	GOLD		
3	INSULATOR	TEFLON	NATURAL		
2	BODY	BRASS	GOLD		
1	DESCRIPTION	MATERIAL	FINISH	QTY	

UNLESS OTHERWISE SPECIFIED DIMENSIONS ARE IN MILLIMETERS. DIMENSIONS IN [] ARE IN INCHES AND FOR OUTLET REVERSE ONLY.
UNLESS OTHERWISE SPECIFIED TOLERANCES FOR MILLIMETERS ARE: 0.5 - 3.0mm ± 0.20mm 3.0 - 120mm ± 0.40mm 120 - 150mm ± 0.50mm
UNLESS OTHERWISE SPECIFIED TOLERANCES FOR INCHES ARE: .020 - .315 ± 0.007" .315 - 1.180 ± 0.015" 1.180 - 4.724 ± 0.025"

APPROVALS	DATE
DRAWN G.R.S.	08/25/04
CHECKED	
DESIGNED	
SHEET 1 OF 1	

PART DESCRIPTION	PART N.B.
SMA DIRECT SOLDER BULKHEAD JACK (FOR .085" , .086" REVERSE POLARITY)	132105RP

DWG. NO.	REV. NC	SIZE	SCALE
132105RP.DWG		A	NA

Amphenol Connex