

# SPECIFICATIONS

(RoHS Compliant)



**Model Number:** SDD48B1-E3  
**Part Number:** 17001218A

**Version:** 00  
**Jun 13, 2018**

## Mechanical Drawing:

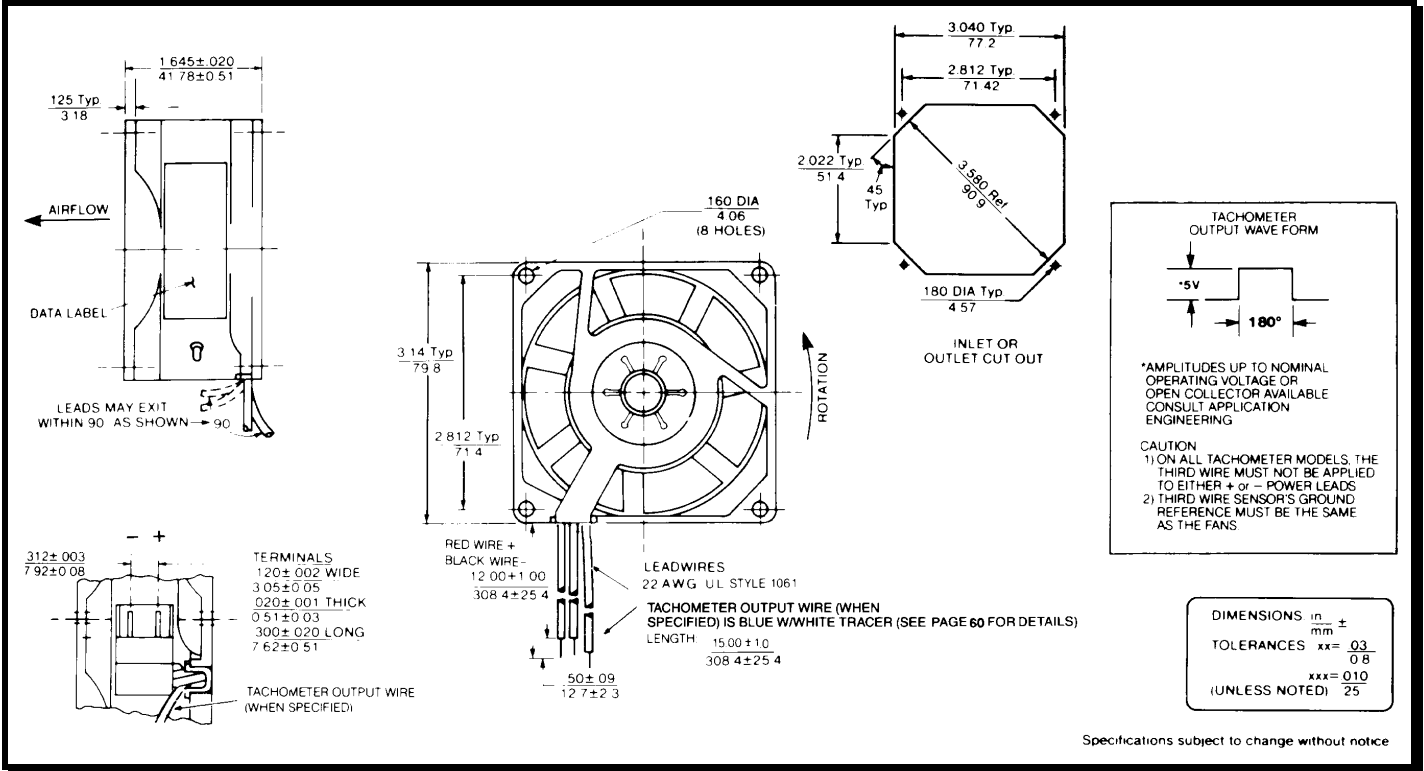

### Motor:

Nominal Voltage	= 48 vdc
Operating Voltage Range	= 36 – 60vdc
Nominal Running Current	= 0.06 amps
Locked Rotor Current	= 0.6 amps
Running Power	= 3.0 watts
Average Speed	= 3500
Bearings	= Ball
Air Flow	= 35 CFM
Acoustic	= 47.6 dBA

### Construction:

Venturi: Single Piece Die-Cast Zinc Alloy, Black  
 Propeller: Plastic, Black, UL 94V-0

### Life Expectancy:

This fan is designed for continuous duty life of 52,000 hours at 70°C.

### Additional Features:

- Brushless DC Motor
- Polarity Protected
- Electronic Locked Rotor Protection
- Automatic Restart Capability
- Operating Temperature: -10°C to 70°C
- Storage Temperature: -40°C to 85°C
- Environmental Protection: Type 3(IP68)

### Termination:

- 12" Lead wires, AWG 22, UL 1061
- Red = Power (+)
- Black = Return (-)

### Agency Approvals:

UL, CUL, CE

**PQ Curve:**

