

Off switch - RS20-US-S0200-0102-014H-001 - 3069706

Please be informed that the data shown in this PDF Document is generated from our Online Catalog. Please find the complete data in the user's documentation. Our General Terms of Use for Downloads are valid (<http://phoenixcontact.com/download>)



Off switch, Connection method: Screw connection, Number of positions: 1, Function: 0 - 1, Switching zones: 1, Switching program number: S0200, Rated continuous current: 20 A, Voltage: 690 V

Why buy this product

- ✓ The compact rotary switch is designed for use in energy technology applications with the available switching programs
- ✓ The use of high-quality materials results in a long mechanical and electrical service life
- ✓ Comprehensive approvals ensure international use
- ✓ High level of safety thanks to non-conductive plastic parts
- ✓ The terminal points are designed in such a way that shock protection according to BGV A2 is ensured
- ✓ The rotary switch is free from cadmium and compliant with the RoHS directive

Key Commercial Data

Packing unit	1 STK
GTIN	 4 046356 771528
GTIN	4046356771528

Technical data

General

Number of connections	4
Color	silver/black
Rotary switch function	0 - 1
Switching program number	S0200
Switching angle	60 °
Rated continuous current	20 A
Maximum load current	20 A
Rated surge voltage	6 kV
Rated insulation voltage	690 V (Valid for networks with grounded neutral point, overvoltage category III, degree of pollution 3)

Off switch - RS20-US-S0200-0102-014H-001 - 3069706

Technical data

General

Rated operating current according to AC-15 (switching of solenoid drives, contactors, valves, pulling electromagnets)	5 A (220 - 240 V)
	4 A (380 - 440 V)
Rated operating current according to AC-21A (switching of ohmic loads including small overloads)	20 A
Rated operating current according to AC-22A (switching of mixed ohmic and inductive loads, including small overloads)	20 A (220 - 500 V)
	20 A (660 - 690 V)
Switching power according to AC-3 (squirrel-cage motors: direct starting, switching off motors during operation, star-delta startup (CH16B))	3 kW (220 - 240 V; 3-phase, 3-pos.)
	5.5 kW (380 - 440 V; 3-phase, 3-pos.)
	5.5 kW (500 V; 3-phase, 3-pos.)
	5.5 kW (660 - 690 V; 3-phase, 3-pos.)
	0.6 kW (110 - 120 V; 1-phase, 2-pos.)
	2.2 kW (220 - 240 V; 1-phase, 2-pos.)
	3 kW (380 - 440 V; 1-phase, 2-pos.)
Switching power according to AC-4 (squirrel-cage motors: starting, reversing, plugging, inching)	0.55 kW (220 - 240 V; 3-phase, 3-pos.)
	1.5 kW (380 - 440 V; 3-phase, 3-pos.)
	1.5 kW (500 V; 3-phase, 3-pos.)
	1.5 kW (660 - 690 V; 3-phase, 3-pos.)
	0.3 kW (110 - 120 V; 1-phase, 2-pos.)
	0.75 kW (220 - 240 V; 1-phase, 2-pos.)
	1.5 kW (380 - 440 V; 1-phase, 2-pos.)
Switching power according to AC-23A (frequent switching of motors or other highly inductive loads)	3.7 kW (220 - 240 V; 3-phase, 3-pos.)
	7.5 kW (380 - 440 V; 3-phase, 3-pos.)
	7.5 kW (500 V; 3-phase, 3-pos.)
	7.5 kW (660 - 690 V; 3-phase, 3-pos.)
	0.75 kW (110 - 120 V; 1-phase, 2-pos.)
	2.5 kW (220 - 240 V; 1-phase, 2-pos.)
	3.7 kW (380 - 440 V; 1-phase, 2-pos.)
Breaking capacity	150 A (220 - 240 V)
	150 A (380 - 440 V)
	80 A (660 - 690 V)
Maximum power dissipation for nominal condition	0.9 W
Ambient temperature (operation)	-35 °C ... 55 °C (Open, at 100% load, with peaks up to 60°C)
IP immunity to short-circuiting with maximum backup fuse	25 A (gL/gG characteristics)
Rated short-time current resistance	140 A (1 s current)

Dimensions

Width	48 mm
Length	62.5 mm

Off switch - RS20-US-S0200-0102-014H-001 - 3069706

Technical data

Dimensions

Height	48 mm
Hole diameter	7 mm
Height	29 mm
Installation depth	33.5 mm

Ambient conditions

Ambient temperature (operation)	-35 °C ... 55 °C (Open, at 100% load, with peaks up to 60°C)
---------------------------------	--

Connection data

Conductor cross section solid min.	0.5 mm ²
Conductor cross section solid max.	2.5 mm ²
Conductor cross section AWG min.	20
Conductor cross section AWG max.	14
Conductor cross section flexible min.	0.75 mm ²
Conductor cross section flexible max.	2.5 mm ²
Min. AWG conductor cross section, flexible	18
Max. AWG conductor cross section, flexible	14
Conductor cross section / stranded with ferrule without plastic sleeve min.	2.5 mm ²
Conductor cross section / stranded with ferrule without plastic sleeve max.	2.5 mm ²
Conductor cross section / stranded with ferrule with plastic sleeve min.	1.5 mm ²
Conductor cross section / stranded, with ferrule with plastic sleeve max.	1.5 mm ²
2 conductors with same cross section, solid min.	0.5 mm ²
2 conductors with same cross section, solid max.	2.5 mm ²
Two conductors with the same cross section, AWG solid min.	20
Two conductors with the same cross section, AWG solid max.	14
2 conductors with same cross section, stranded min.	0.75 mm ²
2 conductors with same cross section, stranded max.	2.5 mm ²
Two conductors with the same cross section, AWG stranded, min.	18
Two conductors with the same cross section, AWG stranded, max.	14
2 conductors with the same cross section/stranded, with ferrule and without plastic sleeve, minimum	2.5 mm ²
2 conductors with the same cross section/stranded, with ferrule and without plastic sleeve, maximum	2.5 mm ²
2 conductors with the same cross section/stranded, with ferrule and plastic sleeve, minimum	1.5 mm ²
2 conductors with the same cross section/stranded, with ferrule and plastic sleeve, maximum	1.5 mm ²

Standards and Regulations

Flammability rating according to UL 94	V0
--	----

Environmental Product Compliance

China RoHS	Environmentally friendly use period: unlimited = EFUP-e
------------	---

Off switch - RS20-US-S0200-0102-014H-001 - 3069706

Technical data

Environmental Product Compliance

	No hazardous substances above threshold values
--	--

Drawings

Drilling diagram

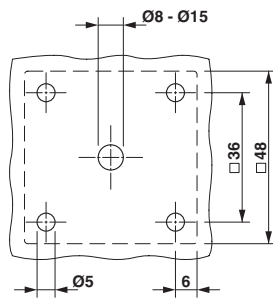

Dimensional drawing

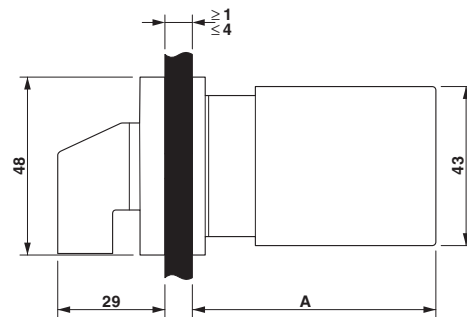

Circuit diagram

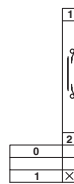
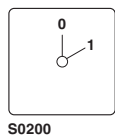

Approvals

Approvals

Approvals

UL Listed / cUL Listed / EAC / cULus Listed

Ex Approvals

Approval details

UL Listed		http://database.ul.com/cgi-bin/XYV/template/LISEXT/1FRAME/index.htm	FILE E 357353
mm ² /AWG/kcmil		20-12	

Off switch - RS20-US-S0200-0102-014H-001 - 3069706

Approvals

Nominal current IN	20 A
Nominal voltage UN	300 V

cUL Listed		http://database.ul.com/cgi-bin/XYV/template/LISEXT/1FRAME/index.htm	FILE E 357353
mm ² /AWG/kcmil		20-12	
Nominal current IN		20 A	
Nominal voltage UN		300 V	

EAC		EAC-Zulassung
-----	---	---------------

cULus Listed	
--------------	---

Phoenix Contact 2017 © - all rights reserved
<http://www.phoenixcontact.com>

PHOENIX CONTACT GmbH & Co. KG
Flachsmarktstr. 8
32825 Blomberg
Germany
Tel. +49 5235 300
Fax +49 5235 3 41200
<http://www.phoenixcontact.com>