

KEMET Part Number: CK06BX224K
(C062K224K5X5CA)

LDD Mil X7R C11015, Ceramic, Military/High Reliability, 0.22 uF, 10%, 50 VDC, BX, N/A, Lead Spacing = 5.08mm

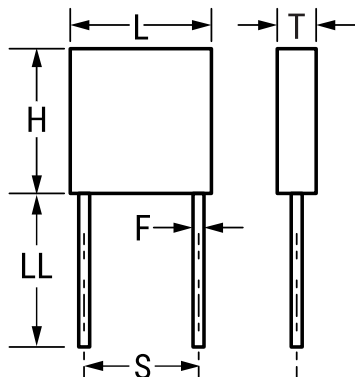

Dimensions

L	7.37mm +/-0.25mm
H	7.37mm +/-0.25mm
T	2.29mm +/-0.25mm
S	5.08mm +/-0.38mm
LL	31.75mm MIN
F	0.635mm +/-0.051mm

Packaging Specifications

Packaging:	Bulk, Bag
Packaging Quantity:	100

General Information

Supplier:	KEMET
Series:	LDD Mil X7R C11015
Style:	Radial
RoHS:	No
Termination:	Lead (SnPb)
Failure Rate:	N/A
Testing and Reliability:	MIL-PRF-11015
Qualifications:	MIL-PRF-11015
Notes:	Lead Length Shown Is For Parts Supplied In Bulk, See Packaging Specifications For Lead Lengths When Not Provided In Bulk

Specifications

Capacitance:	0.22 uF
Capacitance Tolerance:	10%
Voltage DC:	50 VDC
Dielectric Withstanding Voltage:	125 V
Temperature Range:	-55/+125C
Temperature Coefficient:	BX
Dissipation Factor:	2.5%
Insulation Resistance:	4.5 GOhms