

MT9V124EBKSTCH-GEVB

MT9V124 Evaluation Board User's Manual



ON Semiconductor®

www.onsemi.com

Evaluation Board Overview

The evaluation boards are designed to demonstrate the features of ON Semiconductor's image sensors products. This headboard is intended to plug directly into the Demo 2X system. Test points and jumpers on the board provide access to the clock, I/Os, and other miscellaneous signals.

Features

- Clock Input
 - ◆ Default – 22 MHz Crystal Oscillator
 - ◆ Optional Demo 2X Controlled MCLK
- Two Wire Serial Interface
 - ◆ Selectable Base Address
- Serial LVDS Interface
- ROHS Compliant

EVAL BOARD USER'S MANUAL

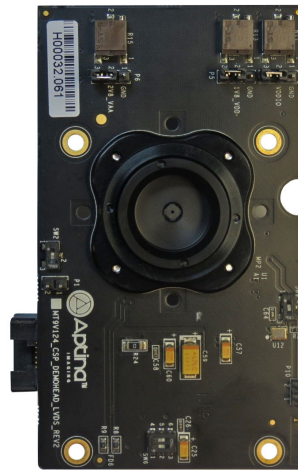

Figure 1. MT9V124 Evaluation Board

Block Diagram

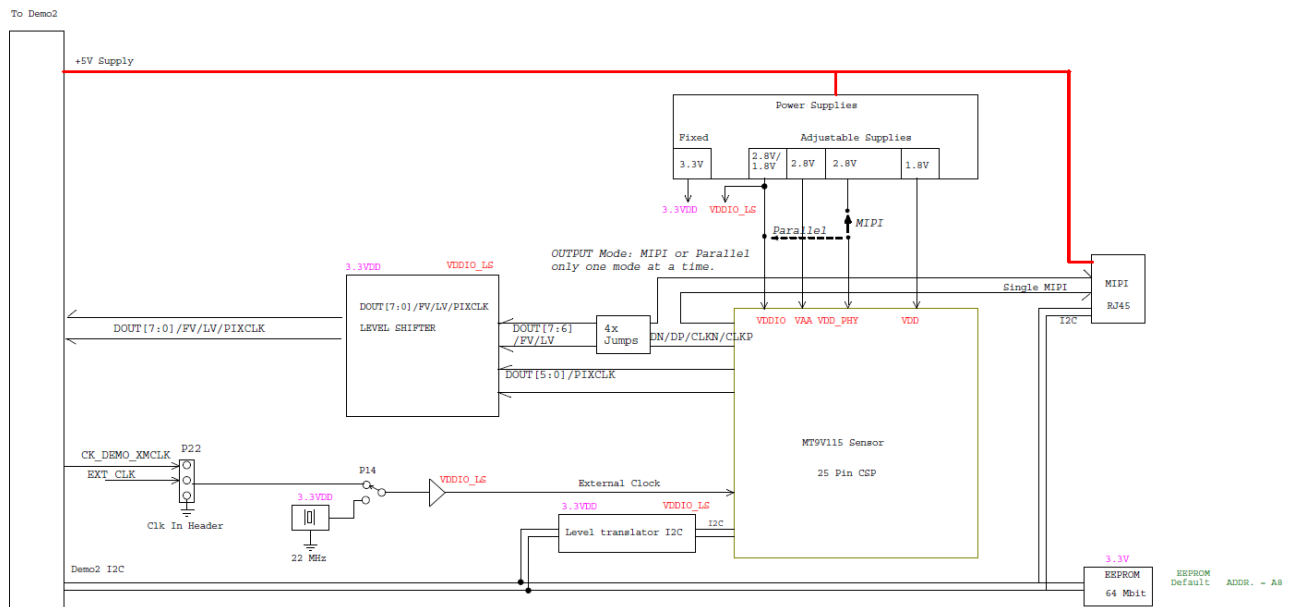

Figure 2. Block Diagram of MT9V124EBKSTCH-GEVB

MT9V124EBKSTCH-GEVB

Top View

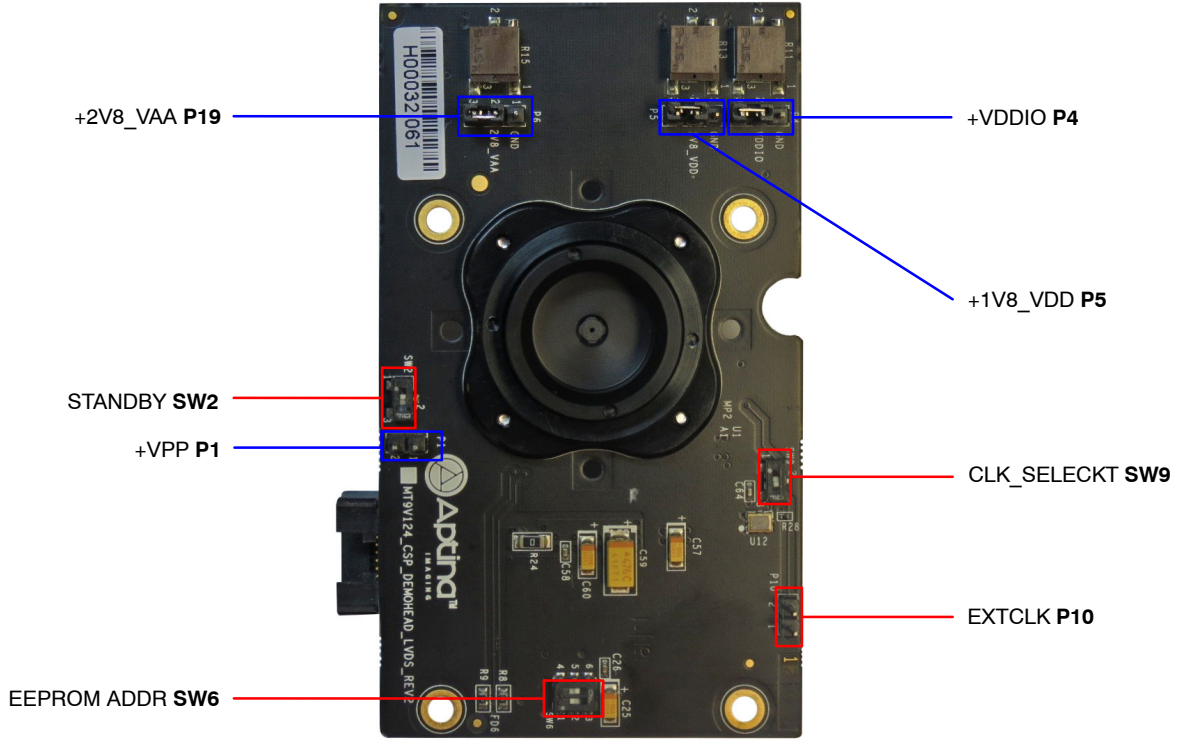

Figure 3. Top View of Evaluation Board – Jumpers

Bottom View

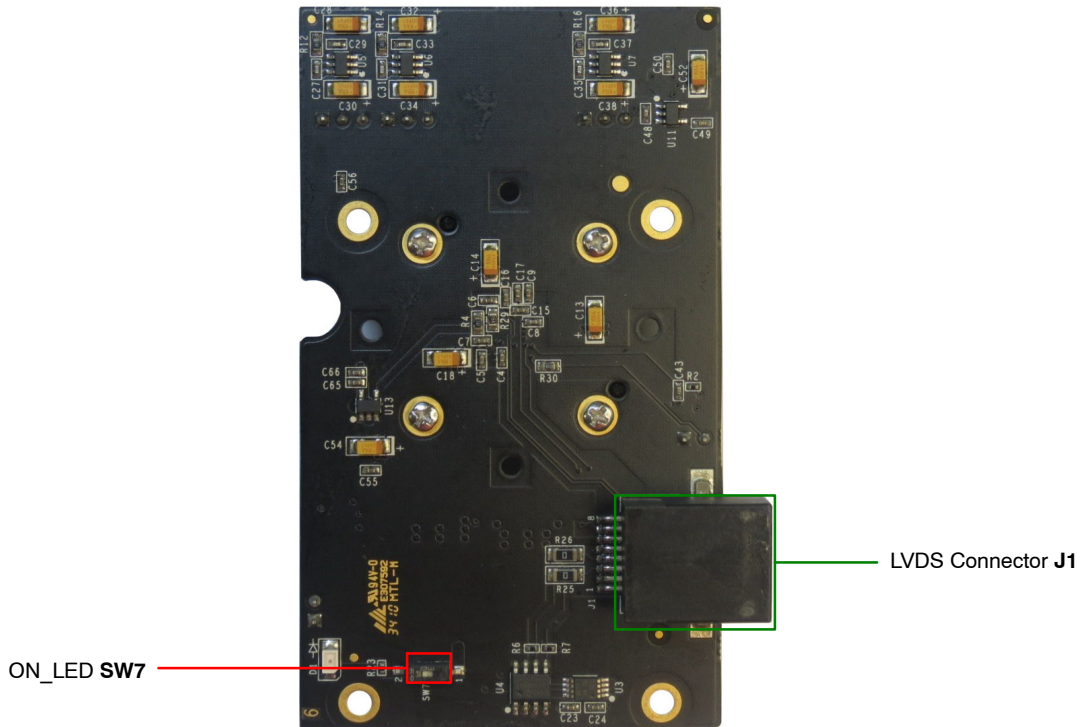

Figure 4. Bottom View of the Evaluation Board – Connectors

MT9V124EBKSTCH-GEVB

Jumper Pin Locations

The jumpers on headboards start with Pin 1 on the leftmost side of the pin. Grouped jumpers increase in pin size with each jumper added.

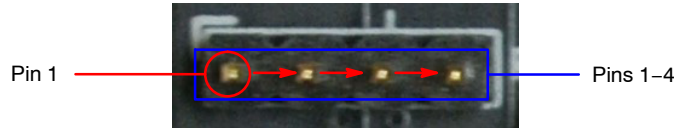

Figure 5. Pin Locations for a Single Jumper. Pin 1 is Located at the Leftmost Side and Increases as it Moves to the Right

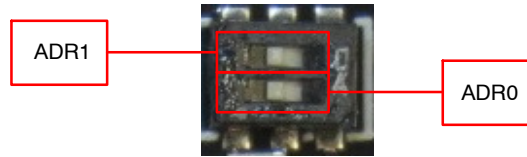

Figure 6. Address Switch Locations in their Default Positions. The first Switch(ADR0) and the second Switch (ADR1) of SW3 are set to ON

Jumper/Header Functions & Default Positions

Table 1. JUMPERS AND HEADERS

Jumper/Header No.	Jumper/Header Name	Pins	Description
P1	+VPP	Open (Default)	For connection to external +VPP supply for OTPM
P4	+VDDIO	2-3 (Default)	Connection to on-board +VDDIO power supply
		1-2	External power supply connection
P5	+1V8_VDD	2-3 (Default)	Connection to on-board +1V8_VDD power supply
		1-2	External power supply connection
P6	+2V8_VAA	2-3 (Default)	Connection to on-board +2V8_VAA power supply
		1-2	External power supply connection
P10	EXTCLK	Open (Default)	For connection to external clock
SW2	STANDBY	1-2 (Default)	Normal Operation
		2-3	Standby Mode
SW6	EEPROM ADDR	A2 On, A1 Off (Default)	EEPROM Address set to 0xA8
		A2 On, A1 On	EEPROM Address set to 0xAC
		A2 Off, A1 On	EEPROM Address set to 0xA4
		A2 Off, A1 Off	EEPROM Address set to 0xA0
SW7	ON_LED	ON (Default)	Turn on LED indicator to indicate power on
		OFF	Turn off LED indicator to indicate power on
SW9	CLK_SELECT	ON (Default)	Select on-board 22 MHz oscillator
		OFF	Select external clock from P10

MT9V124EBKSTCH-GEVB

Interfacing to ON Semiconductor Demo 2X Baseboard

The ON Semiconductor Demo 2X baseboard has a similar connector which mates with J1 of the headboard. The

four mounting holes secure the baseboard and the headboard with spacers and screws.

ON Semiconductor and  are trademarks of Semiconductor Components Industries, LLC dba ON Semiconductor or its subsidiaries in the United States and/or other countries. ON Semiconductor owns the rights to a number of patents, trademarks, copyrights, trade secrets, and other intellectual property. A listing of ON Semiconductor's product/patent coverage may be accessed at www.onsemi.com/site/pdf/Patent-Marking.pdf. ON Semiconductor reserves the right to make changes without further notice to any products herein. ON Semiconductor makes no warranty, representation or guarantee regarding the suitability of its products for any particular purpose, nor does ON Semiconductor assume any liability arising out of the application or use of any product or circuit, and specifically disclaims any and all liability, including without limitation special, consequential or incidental damages. Buyer is responsible for its products and applications using ON Semiconductor products, including compliance with all laws, regulations and safety requirements or standards, regardless of any support or applications information provided by ON Semiconductor. "Typical" parameters which may be provided in ON Semiconductor data sheets and/or specifications can and do vary in different applications and actual performance may vary over time. All operating parameters, including "Typicals" must be validated for each customer application by customer's technical experts. ON Semiconductor does not convey any license under its patent rights nor the rights of others. ON Semiconductor products are not designed, intended, or authorized for use as a critical component in life support systems or any FDA Class 3 medical devices or medical devices with a same or similar classification in a foreign jurisdiction or any devices intended for implantation in the human body. Should Buyer purchase or use ON Semiconductor products for any such unintended or unauthorized application, Buyer shall indemnify and hold ON Semiconductor and its officers, employees, subsidiaries, affiliates, and distributors harmless against all claims, costs, damages, and expenses, and reasonable attorney fees arising out of, directly or indirectly, any claim of personal injury or death associated with such unintended or unauthorized use, even if such claim alleges that ON Semiconductor was negligent regarding the design or manufacture of the part. ON Semiconductor is an Equal Opportunity/Affirmative Action Employer. This literature is subject to all applicable copyright laws and is not for resale in any manner.

PUBLICATION ORDERING INFORMATION

LITERATURE FULFILLMENT:

Literature Distribution Center for ON Semiconductor
19521 E. 32nd Pkwy, Aurora, Colorado 80011 USA
Phone: 303-675-2175 or 800-344-3860 Toll Free USA/Canada
Fax: 303-675-2176 or 800-344-3867 Toll Free USA/Canada
Email: orderlit@onsemi.com

N. American Technical Support: 800-282-9855 Toll Free
USA/Canada
Europe, Middle East and Africa Technical Support:
Phone: 421 33 790 2910
Japan Customer Focus Center
Phone: 81-3-5817-1050

ON Semiconductor Website: www.onsemi.com
Order Literature: <http://www.onsemi.com/orderlit>
For additional information, please contact your local
Sales Representative