

Sensor/Actuator cable - SAC-2P-SUSMS/ 1,5-PUR/SUSFS - 1410760

Please be informed that the data shown in this PDF Document is generated from our Online Catalog. Please find the complete data in the user's documentation. Our General Terms of Use for Downloads are valid (<http://phoenixcontact.com/download>)



Sensor/Actuator cable, 2-position, PUR halogen-free, black-gray RAL 7021, Plug straight Superseal Clip locking, on Socket straight Superseal Clip locking, Cable length: 1.5 m

RoHS

Key Commercial Data

Packing unit	1 STK
GTIN	 4 046356 924481
GTIN	4046356924481

Technical data

Dimensions

Length of cable	1.5 m
-----------------	-------

Ambient conditions

Ambient temperature (operation)	-20 °C ... 85 °C (Superseal)
Degree of protection	IP67

General

Rated current at 40°C	8 A
Rated voltage	24 V
Number of positions	2
Insulation resistance	≥ 100 MΩ
Coding	A - standard
Status display	No
Protective circuit/component	Unwired

Material

Flammability rating according to UL 94	HB
Contact material	CuZn (pin)/PhCuSn (socket)
Contact carrier material	PA 66

Sensor/Actuator cable - SAC-2P-SUSMS/ 1,5-PUR/SUSFS - 1410760

Technical data

Material

Material of grip body	PA
Material, knurls	not available
Sealing material	Silicon

Standards and Regulations

Flammability rating according to UL 94	HB
--	----

Cable

Cable type	PUR halogen-free black
Cable type (abbreviation)	PUR
Cable abbreviation	Li9Y11Y
UL AWM style	20549 / 10493 (80°C/300 V)
Conductor cross section	2x 0.75 mm ² (Signal line)
AWG signal line	18
Conductor structure signal line	42x 0.15 mm
Core diameter including insulation	1.69 mm ±0.05 mm (Signal line)
Thickness, insulation	≥ 0.21 mm
Wire colors	brown, blue
Overall twist	2 wires, twisted
External sheath, color	black-gray RAL 7021
Outer sheath thickness	≥ 0.38 mm
External cable diameter D	4.8 mm ±0.15 mm
Minimum bending radius, fixed installation	5 x D
Minimum bending radius, flexible installation	10 x D
Number of bending cycles	4000000
Bending radius	48 mm
Traversing path	10 m
Traversing rate	3 m/s
Acceleration	10 m/s ²
Cable weight	33 kg/km
Outer sheath, material	PUR
Material conductor insulation	PP
Conductor material	Bare Cu litz wires
Insulation resistance	≥ 1 GΩ*km (at 20 °C)
Conductor resistance	≤ 26 Ω/km (at 20 °C)
Nominal voltage, cable	≤ 300 V AC
Test voltage, cable	≥ 3000 V AC (Spark test)
Special properties	flexible
	Flexible cable conduit capable
Flame resistance	according to UL 758/1581 (horizontal)
	in accordance with UL 758/1581 FT2
	according to DIN EN 60332-2-2

Sensor/Actuator cable - SAC-2P-SUSMS/ 1,5-PUR/SUSFS - 1410760

Technical data

Cable

Halogen-free	in accordance with DIN VDE 0472 part 815
	in accordance with DIN EN 50267-2-1
Resistance to oil	According to DIN EN 60811-2-1, 168 h at 100°C
	According to UL 758, 168 h at 60°C
Other resistance	hydrolysis and microbe resistant
	partly UV-resistant in accordance with DIN EN ISO 4892-2-A
	Low adhesion
	abrasion-resistant
Ambient temperature (operation)	-40 °C ... 80 °C (cable, fixed installation)
	-25 °C ... 80 °C (cable, flexible installation)

Drawings

Schematic diagram

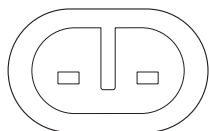

Super seal plug pin assignment, 2-pos.

Schematic diagram

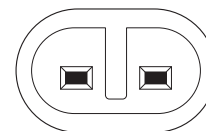

Super seal socket pin assignment, 2-pos.

Cable cross section

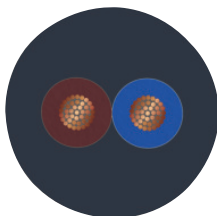

PUR halogen-free black [PUR]

Dimensional drawing

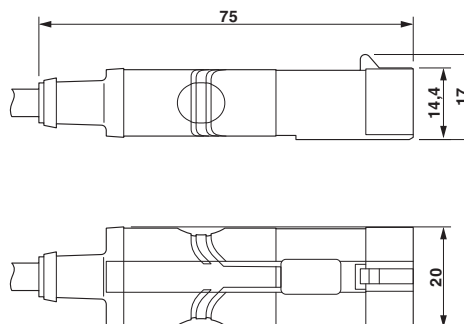

Superseal, plug, view from above and side

Sensor/Actuator cable - SAC-2P-SUSMS/ 1,5-PUR/SUSFS - 1410760

Dimensional drawing

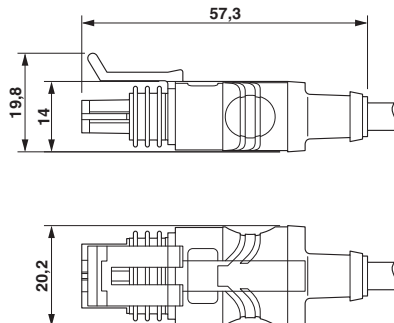

Circuit diagram

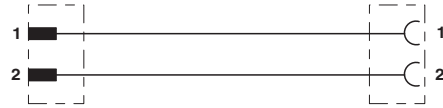

Contact assignment of the super seal plug to the super seal socket

Superseal, socket, view from above and side

Phoenix Contact 2017 © - all rights reserved
<http://www.phoenixcontact.com>

PHOENIX CONTACT GmbH & Co. KG
Flachsmarktstr. 8
32825 Blomberg
Germany
Tel. +49 5235 300
Fax +49 5235 3 41200
<http://www.phoenixcontact.com>